

- Generation V Technology
- Ultra Low On-Resistance
- Dual N and P Channel MOSFET
- Surface Mount
- Fully Avalanche Rated

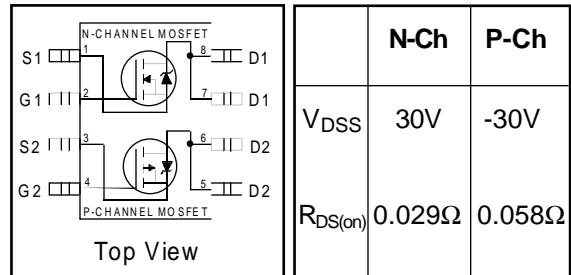

**Description**

Fifth Generation HEXFETs from International Rectifier utilize advanced processing techniques to achieve extremely low on-resistance per silicon area. This benefit, combined with the fast switching speed and ruggedized device design that HEXFET Power MOSFETs are well known for, provides the designer with an extremely efficient and reliable device for use in a wide variety of applications.

The SO-8 has been modified through a customized leadframe for enhanced thermal characteristics and multiple-die capability making it ideal in a variety of power applications. With these improvements, multiple devices can be used in an application with dramatically reduced board space. The package is designed for vapor phase, infra red, or wave soldering techniques.

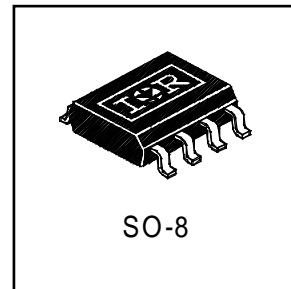

**Absolute Maximum Ratings (  $T_A = 25^\circ\text{C}$  Unless Otherwise Noted)**

	Symbol	Maximum		Units	
		N-Channel	P-Channel		
Drain-Source Voltage	$V_{DS}$	30	-30	V	
Gate-Source Voltage	$V_{GS}$	± 20			
Continuous Drain Current <sup>⑤</sup>	$I_D$	$T_A = 25^\circ\text{C}$	6.5	-4.9	A
		$T_A = 70^\circ\text{C}$	5.2	-3.9	
Pulsed Drain Current	$I_{DM}$	30	-30		
Continuous Source Current (Diode Conduction)	$I_S$	2.5	-2.5		
Maximum Power Dissipation <sup>⑤</sup>	$P_D$	$T_A = 25^\circ\text{C}$	2.0		W
		$T_A = 70^\circ\text{C}$	1.3		
Single Pulse Avalanche Energy	$E_{AS}$	82	140	mJ	
Avalanche Current	$I_{AR}$	4.0	-2.8	A	
Repetitive Avalanche Energy	$E_{AR}$	0.20		mJ	
Peak Diode Recovery dv/dt <sup>②</sup>	dv/dt	5.0	-5.0	V/ ns	
Junction and Storage Temperature Range	$T_J, T_{STG}$	-55 to + 150 °C			

**Thermal Resistance Ratings**

Parameter	Symbol	Limit	Units
Maximum Junction-to-Ambient <sup>⑤</sup>	$R_{\theta JA}$	62.5	°C/W

## Electrical Characteristics @ T<sub>J</sub> = 25°C (unless otherwise specified)

Parameter	Description		Min.	Typ.	Max.	Units	Conditions
V <sub>(BR)DSS</sub>	Drain-to-Source Breakdown Voltage	N-Ch	30	—	—	V	V <sub>GS</sub> = 0V, I <sub>D</sub> = 250μA
		P-Ch	-30	—	—		V <sub>GS</sub> = 0V, I <sub>D</sub> = -250μA
ΔV <sub>(BR)DSS</sub> /ΔT <sub>J</sub>	Breakdown Voltage Temp. Coefficient	N-Ch	—	0.022	—	V/°C	Reference to 25°C, I <sub>D</sub> = 1mA
		P-Ch	—	0.022	—		Reference to 25°C, I <sub>D</sub> = -1mA
R <sub>DS(ON)</sub>	Static Drain-to-Source On-Resistance	N-Ch	—	0.023	0.029	Ω	V <sub>GS</sub> = 10V, I <sub>D</sub> = 5.8A ④
			—	0.032	0.046		V <sub>GS</sub> = 4.5V, I <sub>D</sub> = 4.7A ④
		P-Ch	—	0.042	0.058		V <sub>GS</sub> = -10V, I <sub>D</sub> = -4.9A ④
			—	0.076	0.098		V <sub>GS</sub> = -4.5V, I <sub>D</sub> = -3.6A ④
V <sub>GS(th)</sub>	Gate Threshold Voltage	N-Ch	1.0	—	—	V	V <sub>DS</sub> = V <sub>GS</sub> , I <sub>D</sub> = 250μA
		P-Ch	-1.0	—	—		V <sub>DS</sub> = V <sub>GS</sub> , I <sub>D</sub> = -250μA
g <sub>fs</sub>	Forward Transconductance	N-Ch	—	14	—	S	V <sub>DS</sub> = 15V, I <sub>D</sub> = 5.8A ④
		P-Ch	—	7.7	—		V <sub>DS</sub> = -15V, I <sub>D</sub> = -4.9A ④
I <sub>DSS</sub>	Drain-to-Source Leakage Current	N-Ch	—	—	1.0	μA	V <sub>DS</sub> = 24V, V <sub>GS</sub> = 0V
		P-Ch	—	—	-1.0		V <sub>DS</sub> = -24V, V <sub>GS</sub> = 0V
		N-Ch	—	—	25		V <sub>DS</sub> = 24V, V <sub>GS</sub> = 0V, T <sub>J</sub> = 55°C
		P-Ch	—	—	-25		V <sub>DS</sub> = -24V, V <sub>GS</sub> = 0V, T <sub>J</sub> = 55°C
I <sub>GSS</sub>	Gate-to-Source Forward Leakage	N-P	—	—	±100	nA	V <sub>GS</sub> = ±20V
Q <sub>g</sub>	Total Gate Charge	N-Ch	—	22	33	nC	N-Channel I <sub>D</sub> = 5.8A, V <sub>DS</sub> = 15V, V <sub>GS</sub> = 10V ④
		P-Ch	—	23	34		
Q <sub>gs</sub>	Gate-to-Source Charge	N-Ch	—	2.6	3.9	nC	P-Channel I <sub>D</sub> = -4.9A, V <sub>DS</sub> = -15V, V <sub>GS</sub> = -10V ④
		P-Ch	—	3.8	5.7		
Q <sub>gd</sub>	Gate-to-Drain ("Miller") Charge	N-Ch	—	6.4	9.6	nC	N-Channel V <sub>DD</sub> = 15V, I <sub>D</sub> = 1.0A, R <sub>G</sub> = 6.0Ω, R <sub>D</sub> = 15Ω ④
		P-Ch	—	5.9	8.9		
t <sub>d(on)</sub>	Turn-On Delay Time	N-Ch	—	8.1	12	ns	P-Channel V <sub>DD</sub> = -15V, I <sub>D</sub> = -1.0A, R <sub>G</sub> = 6.0Ω, R <sub>D</sub> = 15Ω ④
P-Ch	—	13	19				
t <sub>r</sub>	Rise Time	N-Ch	—	8.9	13	ns	
		P-Ch	—	13	20		
t <sub>d(off)</sub>	Turn-Off Delay Time	N-Ch	—	26	39	ns	
		P-Ch	—	34	51		
t <sub>f</sub>	Fall Time	N-Ch	—	17	26	ns	
		P-Ch	—	32	48		
C <sub>iss</sub>	Input Capacitance	N-Ch	—	650	—	pF	N-Channel V <sub>GS</sub> = 0V, V <sub>DS</sub> = 25V, f = 1.0MHz
		P-Ch	—	710	—		
C <sub>oss</sub>	Output Capacitance	N-Ch	—	320	—	pF	P-Channel V <sub>GS</sub> = 0V, V <sub>DS</sub> = -25V, f = 1.0MHz
		P-Ch	—	380	—		
C <sub>rss</sub>	Reverse Transfer Capacitance	N-Ch	—	130	—	pF	
		P-Ch	—	180	—		

## Source-Drain Ratings and Characteristics

Parameter	Description		Min.	Typ.	Max.	Units	Conditions
I <sub>S</sub>	Continuous Source Current (Body Diode)	N-Ch	—	—	2.5	A	
		P-Ch	—	—	-2.5		
I <sub>SM</sub>	Pulsed Source Current (Body Diode) ①	N-Ch	—	—	30	A	
		P-Ch	—	—	-30		
V <sub>SD</sub>	Diode Forward Voltage	N-Ch	—	0.78	1.0	V	T <sub>J</sub> = 25°C, I <sub>S</sub> = 1.7A, V <sub>GS</sub> = 0V ③
		P-Ch	—	-0.78	-1.0		T <sub>J</sub> = 25°C, I <sub>S</sub> = -1.7A, V <sub>GS</sub> = 0V ③
t <sub>rr</sub>	Reverse Recovery Time	N-Ch	—	45	68	ns	N-Channel T <sub>J</sub> = 25°C, I <sub>F</sub> = 1.7A, di/dt = 100A/μs ④
		P-Ch	—	44	66		
Q <sub>rr</sub>	Reverse Recovery Charge	N-Ch	—	58	87	nC	P-Channel T <sub>J</sub> = 25°C, I <sub>F</sub> = -1.7A, di/dt = 100A/μs ④
		P-Ch	—	42	63		

### Notes:

- ① Repetitive rating; pulse width limited by max. junction temperature. ( See fig. 22 )
- ② N-Channel I<sub>SD</sub> ≤ 4.0A, di/dt ≤ 74A/μs, V<sub>DD</sub> ≤ V<sub>(BR)DSS</sub>, T<sub>J</sub> ≤ 150°C  
P-Channel I<sub>SD</sub> ≤ -2.8A, di/dt ≤ 150A/μs, V<sub>DD</sub> ≤ V<sub>(BR)DSS</sub>, T<sub>J</sub> ≤ 150°C
- ③ N-Channel Starting T<sub>J</sub> = 25°C, L = 10mH R<sub>G</sub> = 25Ω, I<sub>AS</sub> = 4.0A. (See Figure 12)  
P-Channel Starting T<sub>J</sub> = 25°C, L = 35mH R<sub>G</sub> = 25Ω, I<sub>AS</sub> = -2.8A.
- ④ Pulse width ≤ 300μs; duty cycle ≤ 2%.
- ⑤ Surface mounted on FR-4 board, t ≤ 10sec.

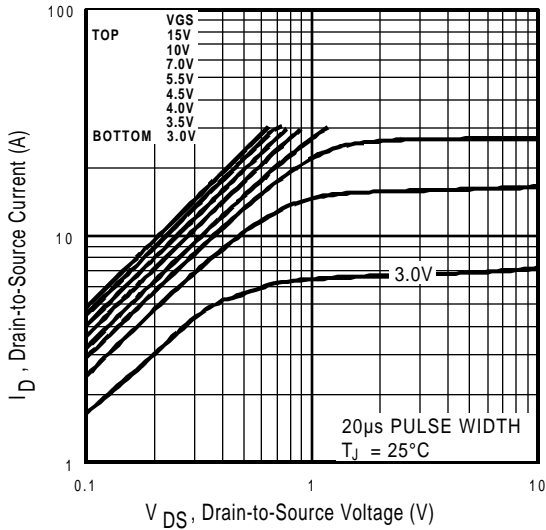

**Fig 1.** Typical Output Characteristics

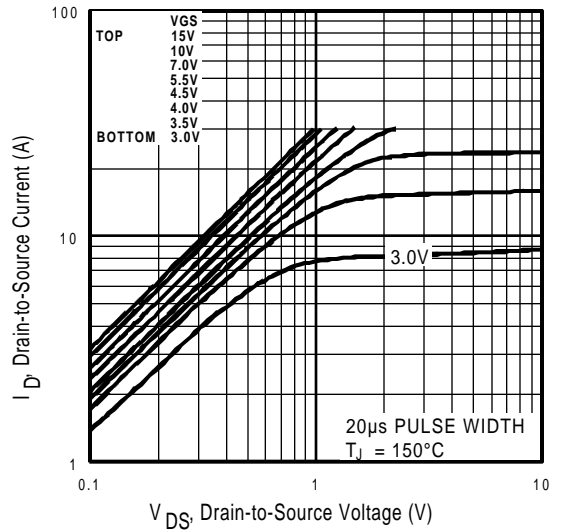

**Fig 2.** Typical Output Characteristics

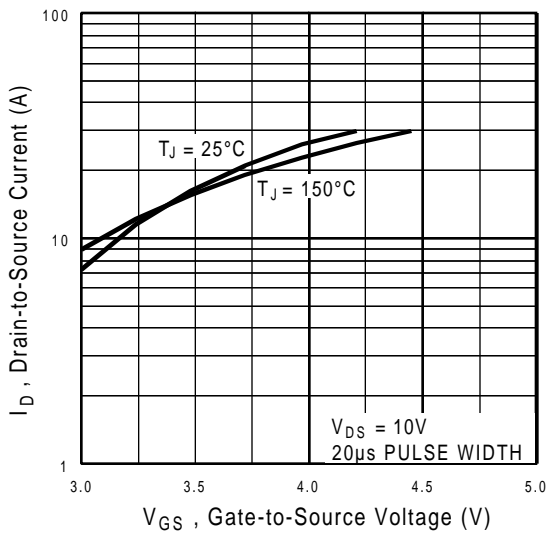

**Fig 3.** Typical Transfer Characteristics

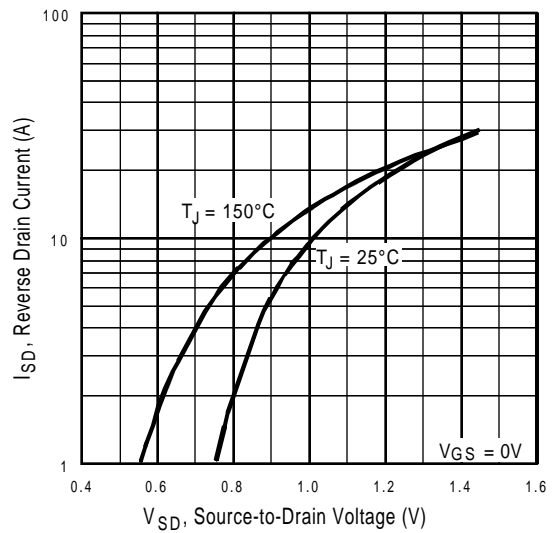

**Fig 4.** Typical Source-Drain Diode Forward Voltage

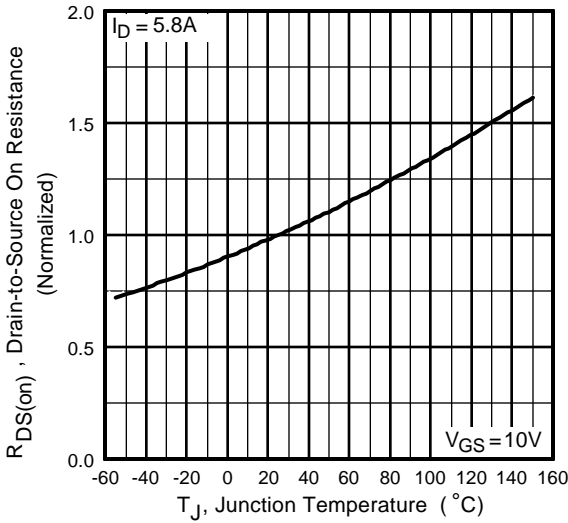

**Fig 5.** Normalized On-Resistance Vs. Temperature

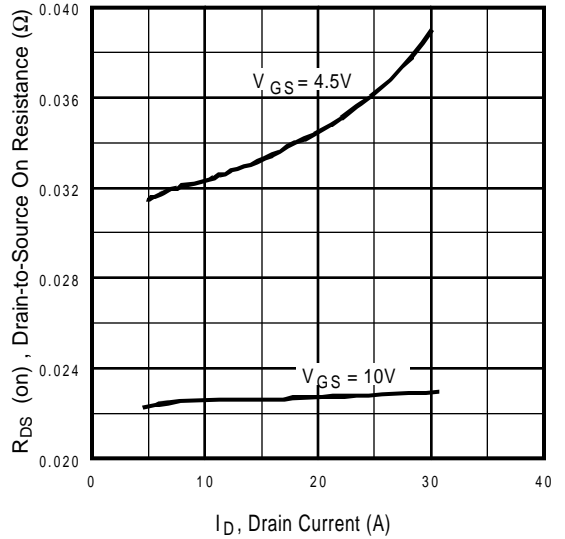

**Fig 6.** Typical On-Resistance Vs. Drain Current

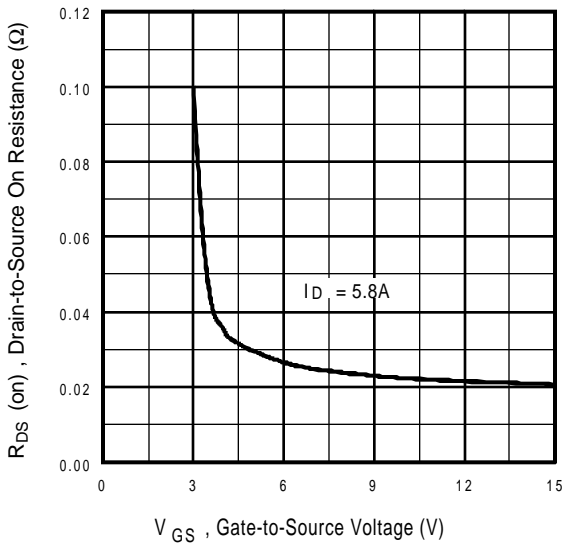

**Fig 7.** Typical On-Resistance Vs. Gate Voltage

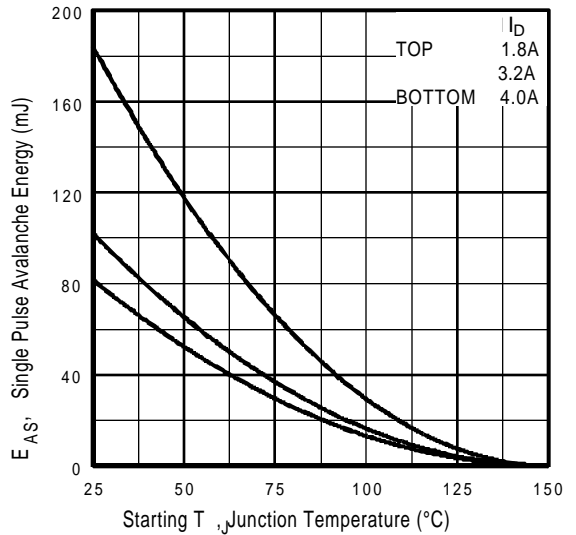

**Fig 8.** Maximum Avalanche Energy Vs. Drain Current

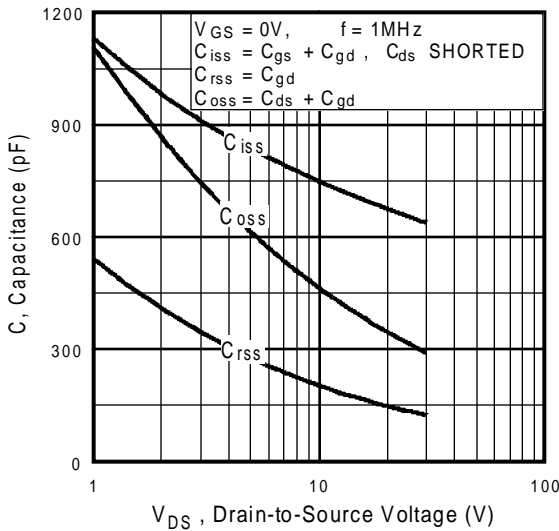

**Fig 9.** Typical Capacitance Vs. Drain-to-Source Voltage

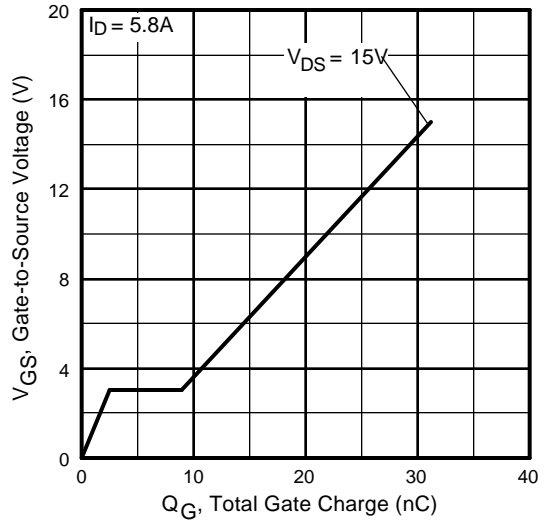

**Fig 10.** Typical Gate Charge Vs. Gate-to-Source Voltage

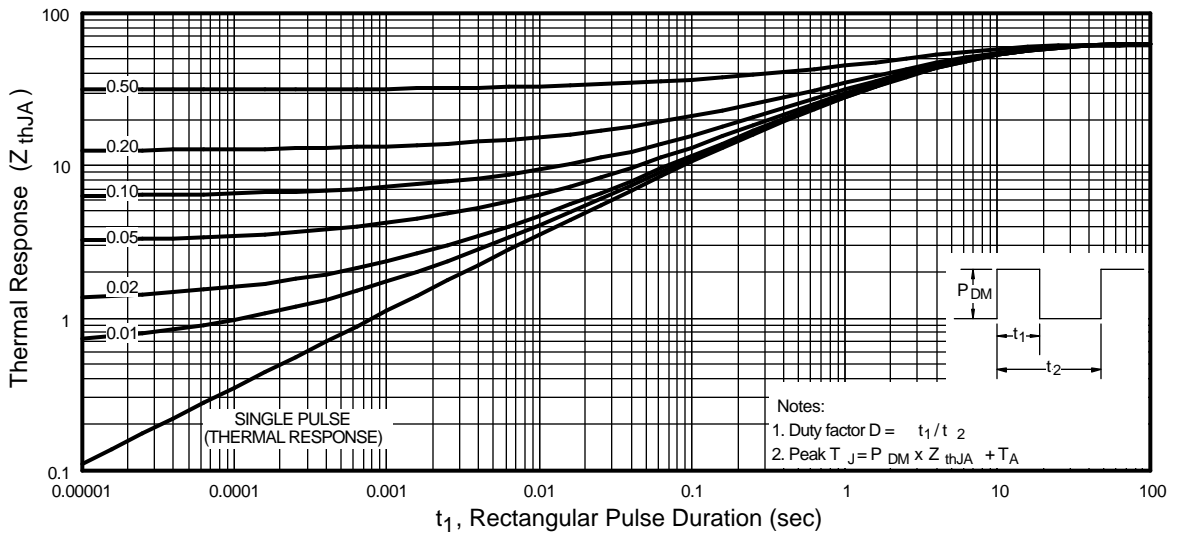

**Fig 11.** Maximum Effective Transient Thermal Impedance, Junction-to-Ambient

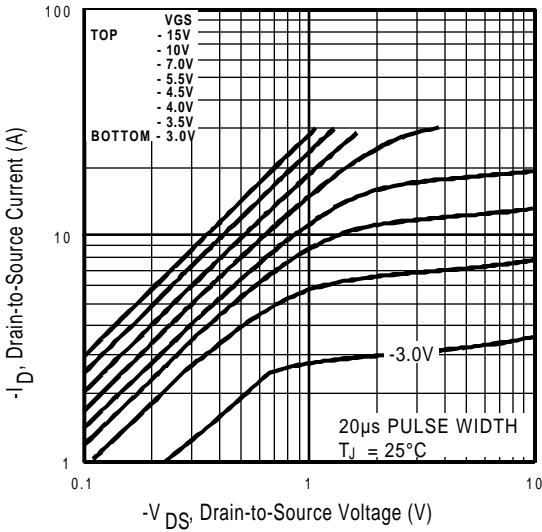

**Fig 12.** Typical Output Characteristics

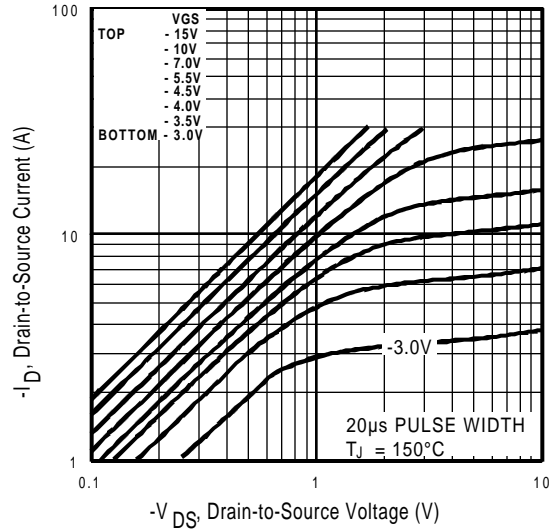

**Fig 13.** Typical Output Characteristics

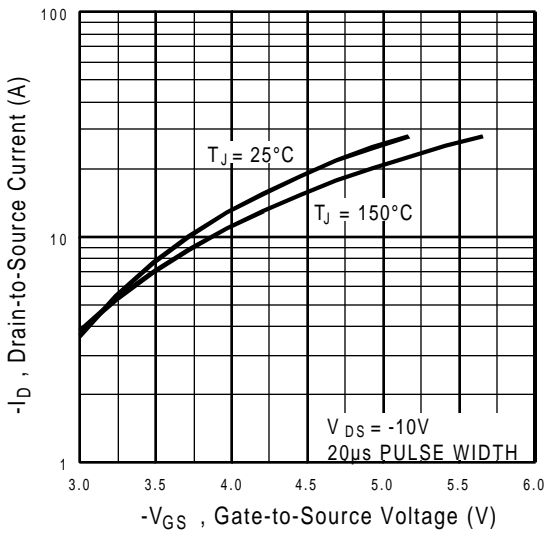

**Fig 14.** Typical Transfer Characteristics

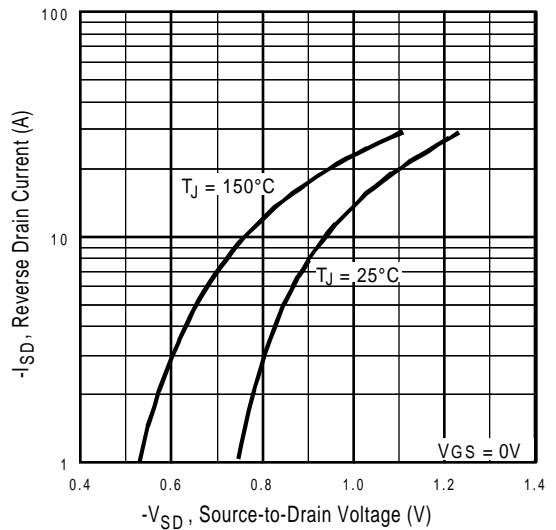

**Fig 15.** Typical Source-Drain Diode Forward Voltage

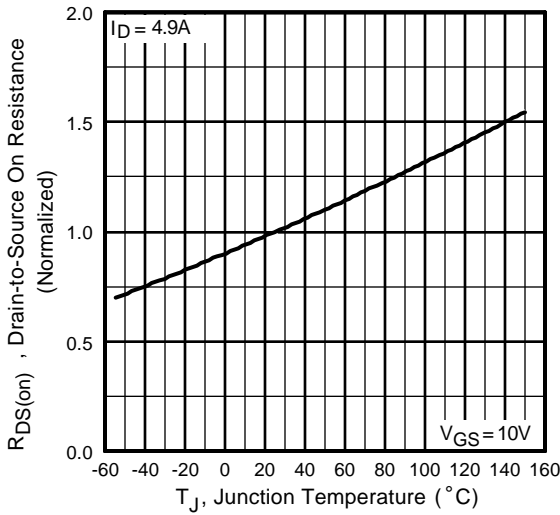

**Fig 16.** Normalized On-Resistance Vs. Temperature

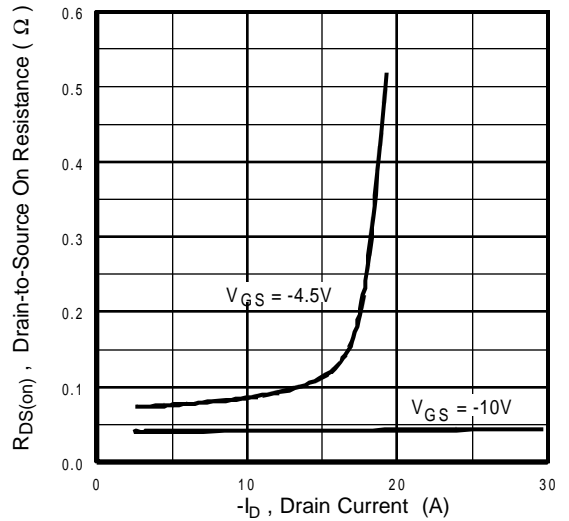

**Fig 17.** Typical On-Resistance Vs. Drain Current

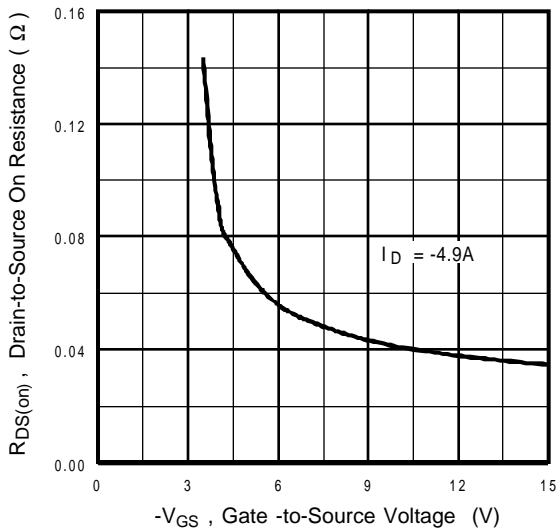

**Fig 18.** Typical On-Resistance Vs. Gate Voltage

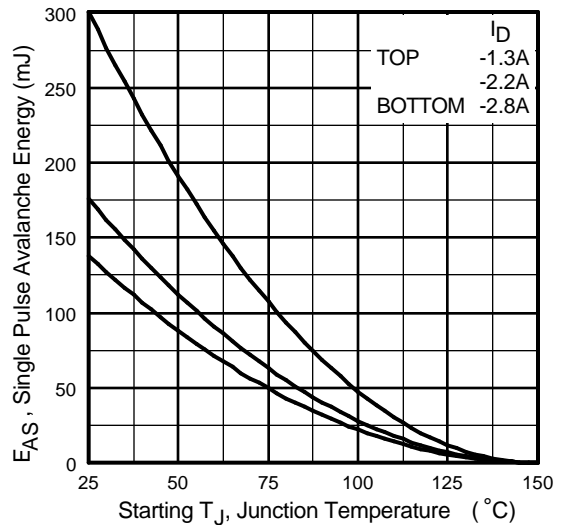

**Fig 19.** Maximum Avalanche Energy Vs. Drain Current

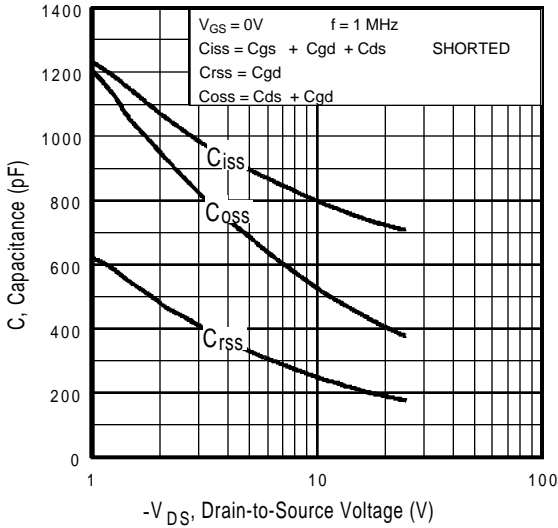

**Fig 20.** Typical Capacitance Vs. Drain-to-Source Voltage

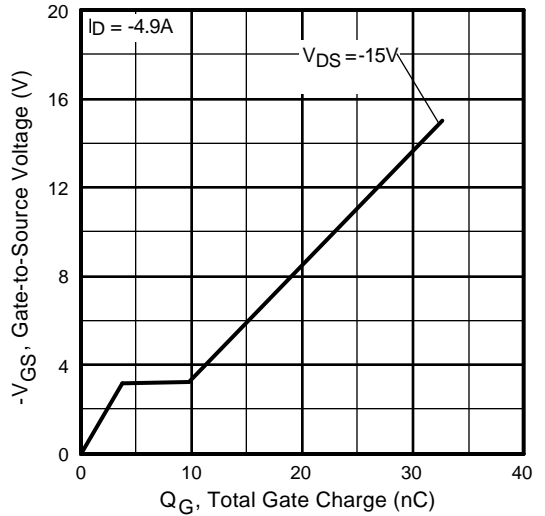

**Fig 21.** Typical Gate Charge Vs. Gate-to-Source Voltage

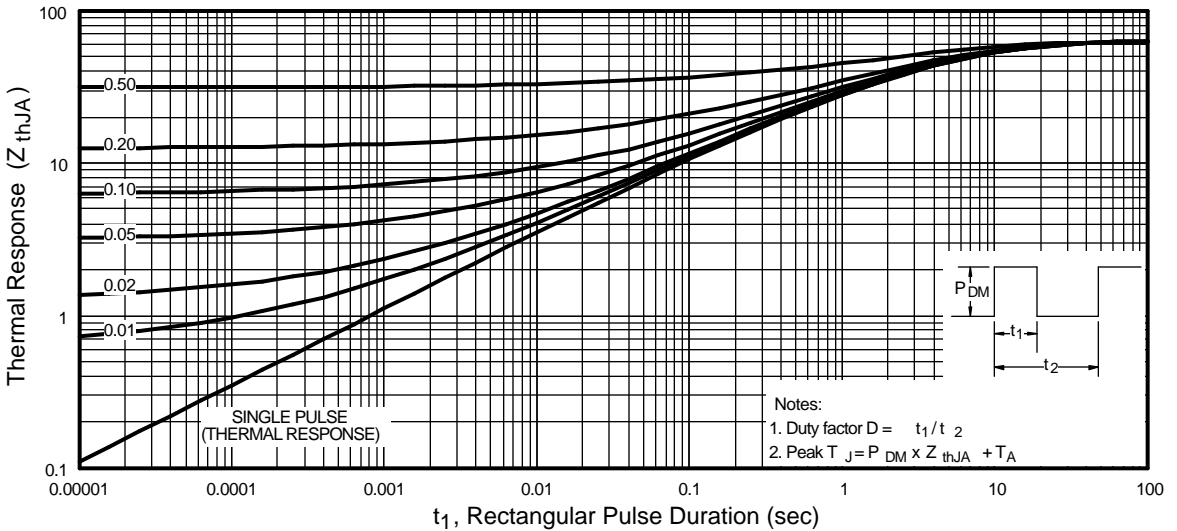
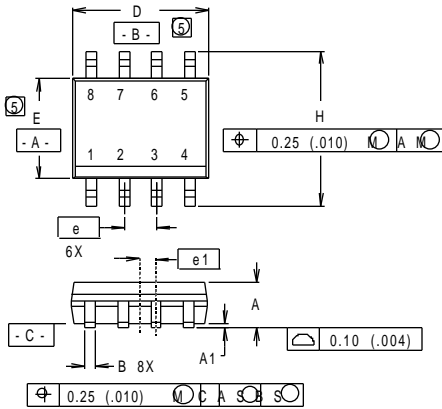

**Fig 22.** Maximum Effective Transient Thermal Impedance, Junction-to-Ambient



## Package Outline

### SO8 Outline



DIM	INCHES		MILLIMETERS	
	MIN	MAX	MIN	MAX
A	.0532	.0688	1.35	1.75
A1	.0040	.0098	0.10	0.25
B	.014	.018	0.36	0.46
C	.0075	.0098	0.19	0.25
D	.189	.196	4.80	4.98
E	.150	.157	3.81	3.99
e	.050 BASIC		1.27 BASIC	
e1	.025 BASIC		0.635 BASIC	
H	.2284	.2440	5.80	6.20
K	.011	.019	0.28	0.48
L	0.16	.050	0.41	1.27
theta	0°	8°	0°	8°

#### RECOMMENDED FOOTPRINT

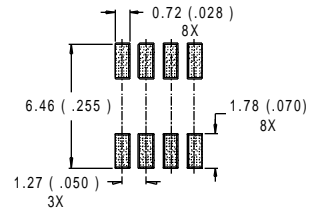

#### NOTES:

1. DIMENSIONING AND TOLERANCING PER ANSI Y14.5M-1982.
  2. CONTROLLING DIMENSION : INCH.
  3. DIMENSIONS ARE SHOWN IN MILLIMETERS (INCHES).
  4. OUTLINE CONFORMS TO JEDEC OUTLINE MS-012AA.
- (S) DIMENSION DOES NOT INCLUDE MOLD PROTRUSIONS  
MOLD PROTRUSIONS NOT TO EXCEED 0.25 (.006).
- (S) DIMENSIONS IS THE LENGTH OF LEAD FOR SOLDERING TO A SUBSTRATE..

## Part Marking Information

### SO8

EXAMPLE : THIS IS AN IRF7101

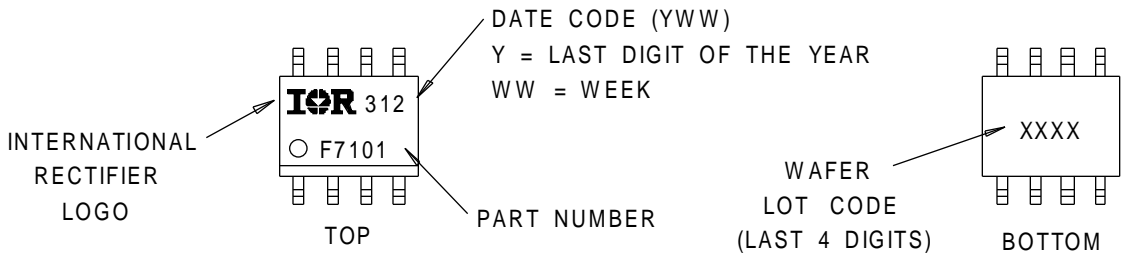

# IRF7319

## Tape & Reel Information

**S08**

Dimensions are shown in millimeters (inches)

