

# THYRISTOR MODULE (NON-ISOLATED TYPE)

## PWB60A

TOP



PWB60A is a Thyristor module suitable for low voltage, 3 phase recifier applications.

- $I_{T(AV)}$  60A (each device)
- High Surge Current 1800 A (60Hz)
- Easy Construction
- Non-isolated. Mounting base as common Anode terminal

### (Applications)

Welding power Supply  
Various DC power Supply

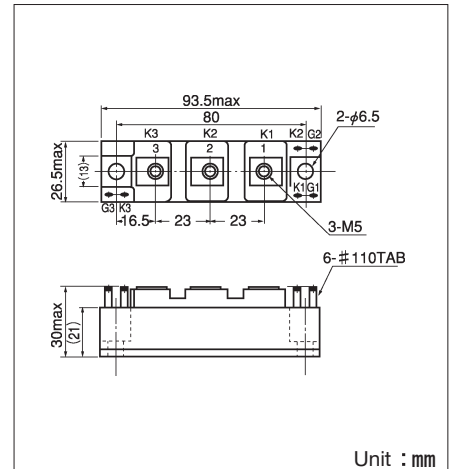
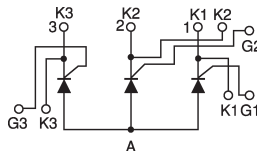

### Maximum Ratings

Symbol	Item	Ratings		Unit
		PWB60A30	PWB60A40	
VRRM	Repetitive Peak Reverse Voltage	300	400	V
VRSM	Non-Repetitive Peak Reverse Voltage	360	480	V
VDRM	Repetitive Peak Off-State Voltage	300	400	V

Symbol	Item	Conditions	Ratings	Unit	
$I_{T(AV)}$	Average On-State Current	Single phase, half wave, 180° conduction, $T_c : 123^\circ\text{C}$	60	A	
$I_{T(RMS)}$	R.M.S. On-State Current	Single phase, half wave, 180° conduction, $T_c : 123^\circ\text{C}$	94	A	
$I_{TSM}$	Surge On-State Current	$\frac{1}{2}$ cycle, 50Hz/60Hz, peak value, non-repetitive	1640/1800	A	
$I^2t$	$I^2t$		13,500	A <sup>2</sup> S	
P <sub>GM</sub>	Peak Gate Power Dissipation		10	W	
P <sub>G(AV)</sub>	Average Gate Power Dissipation		1	W	
I <sub>FGM</sub>	Peak Gate Current		3	A	
V <sub>FGM</sub>	Peak Gate Voltage (Forward)		10	V	
V <sub>RGM</sub>	Peak Gate Voltage (R.M.S.)		5	V	
di/dt	Critical Rate of Rise of On-State Current	$I_G=150\text{mA}, T_j=25^\circ\text{C}, V_D=\frac{1}{2}V_{DRM}, dI_G/dt=1\text{A}/\mu\text{s}$	50	A/ $\mu\text{s}$	
T <sub>j</sub>	Operating Junction Temperature		-30~+150	°C	
T <sub>stg</sub>	Storage Temperature		-30~+125	°C	
	Mounting torque	Mounting (M6)	Recommended Value 2.5~3.9 (25~40)	4.7 (48)	N·m (kgf·cm)
		Terminal (M5)	Recommended Value 1.5~2.5 (15~25)	2.7 (28)	
	Mass			170	g

### Electrical Characteristics

Symbol	Item	Conditions	Ratings	Unit
I <sub>DRM</sub>	Repetitive Peak Off-State Current, max.	at $V_{DRM}$ , single phase, half wave, $T_j=150^\circ\text{C}$	10	mA
I <sub>RRM</sub>	Repetitive Peak Reverse Current, max.	at $V_{DRM}$ , single phase, half wave, $T_j=150^\circ\text{C}$	10	mA
V <sub>TM</sub>	Peak On-State Voltage, max.	On-State Current 180A, $T_j=25^\circ\text{C}$ Inst. measurement	1.25	V
I <sub>GT</sub> /V <sub>GT</sub>	Gate Trigger Current/Voltage, max.	$T_j=25^\circ\text{C}, I_T=1\text{A}, V_D=6\text{V}$	150/2	mA/V
V <sub>GD</sub>	Non-Trigger Gate, Voltage, min.	$T_j=150^\circ\text{C}, V_D=\frac{1}{2}V_{DRM}$	0.25	V
t <sub>gt</sub>	Turn On Time, max.	$I_T=60\text{A}, I_G=150\text{mA}, T_j=25^\circ\text{C}, V_D=\frac{1}{2}V_{DRM}, dI_G/dt=1\text{A}/\mu\text{s}$	10	$\mu\text{s}$
dv/dt	Critical Rate of Rise of Off-State Voltage, min.	$T_j=150^\circ\text{C}, V_D=\frac{2}{3}V_{DRM}$ , Exponential wave.	50	V/ $\mu\text{s}$
I <sub>H</sub>	Holding Current, typ.	$T_j=25^\circ\text{C}$	100	mA
R <sub>th(j-c)</sub>	Thermal Impedance, max.	Junction to case ( $\frac{1}{3}$ Module)	0.35	°C/W

Gate Characteristics

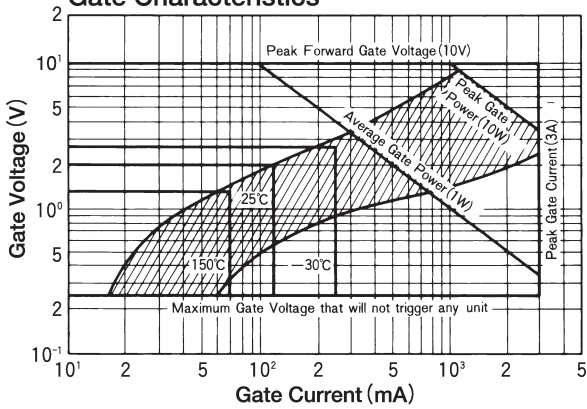

On-State Voltage max

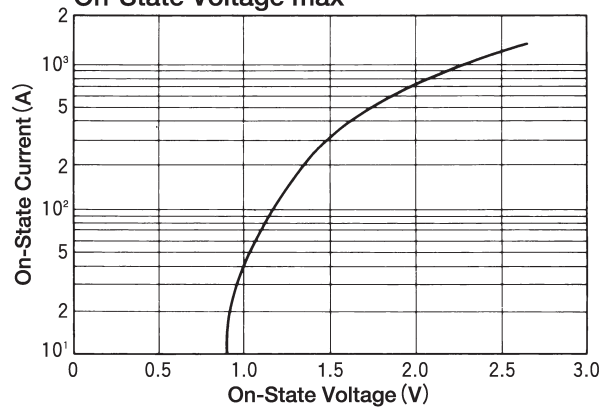

Average On-State Current Vs Power Dissipation (Single phase half wave)

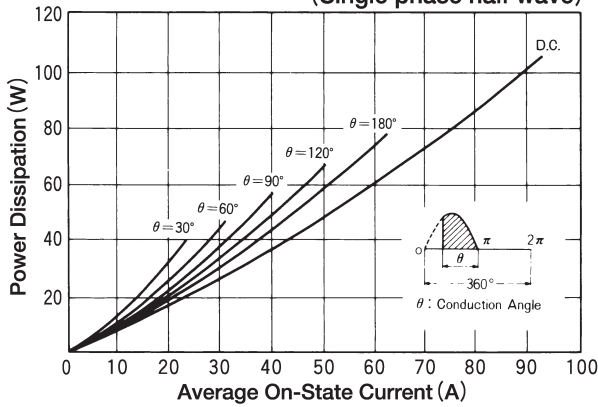

Average On-State Current Vs Maximum Allowable Case Temperature (Single phase half wave)

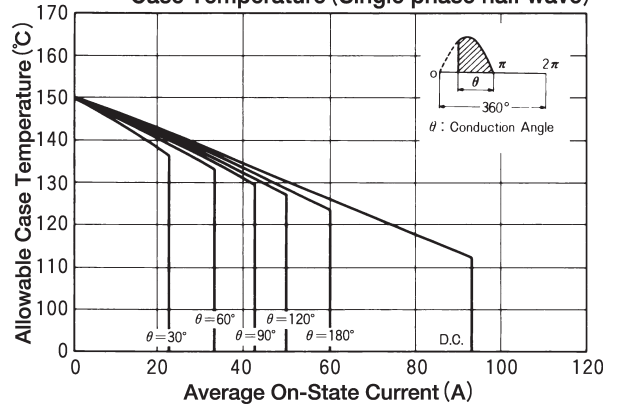

Surge On-State Current Rating (Non-Repetitive)

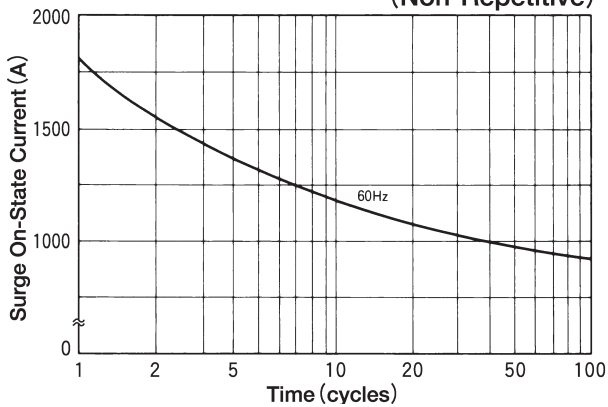

Transient Thermal Impedance

