

TOSHIBA BIPOLAR LINEAR INTEGRATED CIRCUIT SILICON MONOLITHIC

TA2058F**POWER DRIVER IC FOR CD PLAYER**

TA2058F is a power driver IC developed for CD players. This IC have built-in 4 channel BTL power amplifiers which drives focus-coil and tracking coil for 3-beam pick-up head, disc motor and feed motor.

FEATURES

- 4 channel BTL linear divers
- Few external parts
- Fixed voltage gain
: $G_v = 15\text{dB}$ (Typ.)
- High output power
: $V_{OM1} = 5V_{p-p}$ (Typ.) $V_{CC} = 5V$, $R_L = 50\Omega$
: $V_{OM2} = 6V_{p-p}$ (Typ.) $V_{CC} = 6V$, $R_L = 50\Omega$
- Thermal shut down protector
- Input reference voltage short protector
- Small Package
: Power-flat package 1mm pitch 20pins
- Operation Supply Voltage Range
: $V_{CC}(\text{opr}) = 4.0 \sim 10.0V$ ($T_a = 25^\circ\text{C}$)

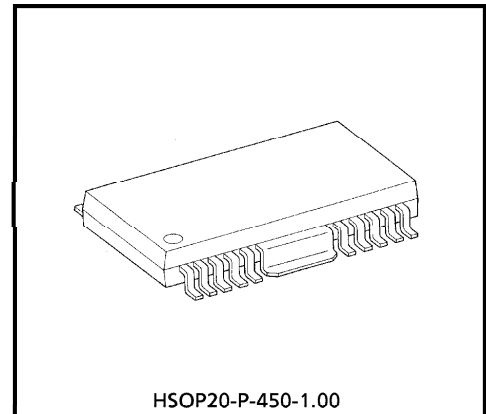

Weight : 0.8g (Typ.)

980508EBA2

- TOSHIBA is continually working to improve the quality and the reliability of its products. Nevertheless, semiconductor devices in general can malfunction or fail due to their inherent electrical sensitivity and vulnerability to physical stress. It is the responsibility of the buyer, when utilizing TOSHIBA products, to observe standards of safety, and to avoid situations in which a malfunction or failure of a TOSHIBA product could cause loss of human life, bodily injury or damage to property. In developing your designs, please ensure that TOSHIBA products are used within specified operating ranges as set forth in the most recent products specifications. Also, please keep in mind the precautions and conditions set forth in the TOSHIBA Semiconductor Reliability Handbook.
- The products described in this document are subject to foreign exchange and foreign trade laws.
- The information contained herein is presented only as a guide for the applications of our products. No responsibility is assumed by TOSHIBA CORPORATION for any infringements of intellectual property or other rights of the third parties which may result from its use. No license is granted by implication or otherwise under any intellectual property or other rights of TOSHIBA CORPORATION or others.
- The information contained herein is subject to change without notice.

BLOCK DIAGRAM

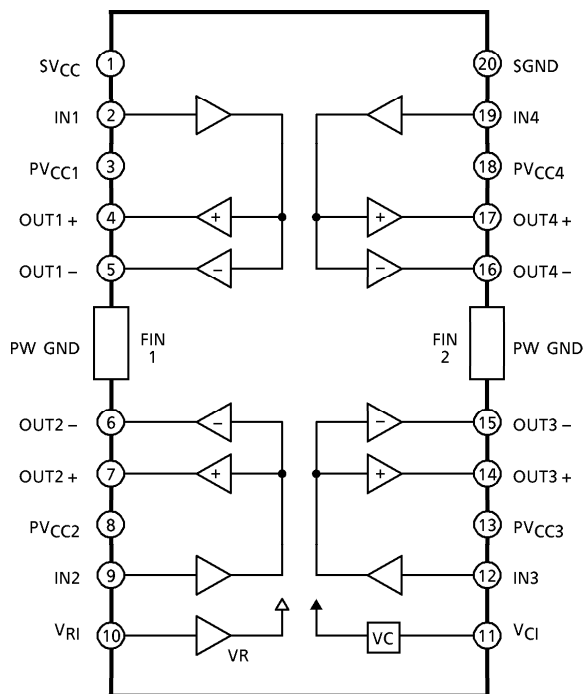

TERMINAL EXPLANATION

TERMINAL No.	SYMBOL	FUNCTION	EQUIVALENT CIRCUIT
1	SV _{CC}	Supply terminal of small signal	
2	IN1	Input for CH1 <ul style="list-style-type: none"> Not biased inside. 	
3	PV _{CC1}	Supply terminal of output stage for CH1 <ul style="list-style-type: none"> Supply terminal of output stage are not connected to other channel terminal. 	
4	OUT1 +	Non-inverted output for CH1	
5	OUT1 -	Inverted output for CH1	
FIN1	PGND	Power GND <ul style="list-style-type: none"> Connected to FIN2 and substrate. 	
6	OUT2 -	Inverted output for CH2	
7	OUT2 +	Non-inverted output for CH2	
8	PV _{CC2}	Supply terminal of output stage for CH2	
9	IN2	Input for CH2	
10	V _{R1}	Input reference voltage <ul style="list-style-type: none"> Under condition of $V_{R1} \leq 1.8V$, internal bias circuit is shut off. 	
11	V _{Cl}	Output reference voltage <ul style="list-style-type: none"> $V_{OUT} = V_{Cl} = (V_{CC} - V_F) / 2$ 	
12	IN3	Input for CH3	Same as CH1
13	PV _{CC3}	Supply terminal of output stage for CH3	
14	OUT3 +	Non-inverted output for CH3	
15	OUT3 -	Inverted output for CH3	Connected to FIN1
FIN2	PGND	Power GND	
16	OUT4 -	Inverted output for CH4	Same as CH1
17	OUT4 +	Non-inverted output for CH4	
18	PV _{CC4}	Supply terminal of output stage for CH4	
19	IN4	Input for CH4	
20	SGND	Small signal GND	

MAXIMUM RATINGS (Ta = 25°C)

CHARACTERISTIC	SYMBOL	RATING	UNIT
Supply Voltage	V _{CC}	14	V
Power Dissipation	P _D (Note 1)	2 (Note 2)	W
Operating Temperature	T _{opr}	-30~85	°C
Storage Temperature	T _{stg}	-55~150	°C

(Note 1) : Mounted on 50mm × 50mm × 1.6mm size board with copper area 60% over.

(Note 2) : Derated above Ta = 25°C, in the proportion of 62.5mW/°C.

ELECTRICAL CHARACTERISTICS

(Unless otherwise specified, V_{CC} = 5V, R_L = 5Ω, R_g = 620Ω, V_{RI} = 2.1V, f = 1kHz, Ta = 25°C)

CHARACTERISTIC	SYMBOL	TEST CIRCUIT	TEST CONDITION	MIN.	TYP.	MAX.	UNIT
Operating Voltage	V _{CC}	—		4.0	—	10.0	V
Quiescent Current	I _{CCQ}	—	V _{in} = 0, R _L = OPEN	20	35	60	mA
Input Offset Current	I _{IIN}	—	V _{IN} = 2.1V	—	250	800	nA
V _{RI} Terminal Offset Current	I _{I0}	—	V _{RI} = 2.1V	—	35	120	μA
Output Offset Voltage	V _{O OS1}	—	V _{CC} = 5V, R _g = 0Ω	-30	—	30	mV
	V _{O OS2}	—	V _{CC} = 8V, R _g = 0Ω	-50	—	50	
	V _{O OS3}	—	V _{CC} = 12V, R _g = 0Ω	-100	—	100	
Reference Output Voltage	V _{OUT}	—		—	2.1	—	V
Maximum Output Voltage	V _{OM1}	—	V _{CC} = 5V	4.0	5.0	—	V _{p-p}
	V _{OM2}	—	V _{CC} = 6V	5.0	6.0	—	
Voltage Gain	G _v	—	V _{in} = 100mV _{rms}	14.5	15.5	16.5	dB
Frequency Response	f _c	—	V _{in} = 100mV _{rms}	—	100	—	kHz
Total Harmonic Distortion	THD	—	V _{in} = 100mV _{rms}	—	-50	—	dB
Slew Rate	S.R.	—	V _{out} = 2V _{p-p}	—	1.0	—	V / μs
Cross Talk	C.T.	—	V _{out} = 1V _{rms}	—	-60	—	dB
Ripple Rejection Ratio	R.R.	—	f _{rip} = 100Hz, V _{rip} = 100mV _{rms}	—	-60	—	dB
Thermal Shut Down Temperature	T _{TSD}	—	Chip temperature	—	150	—	°C
V _{RI} ~GND Short Protection Voltage	V _{RI OFF}	—		1.4	1.6	1.8	V

TEST CIRCUIT

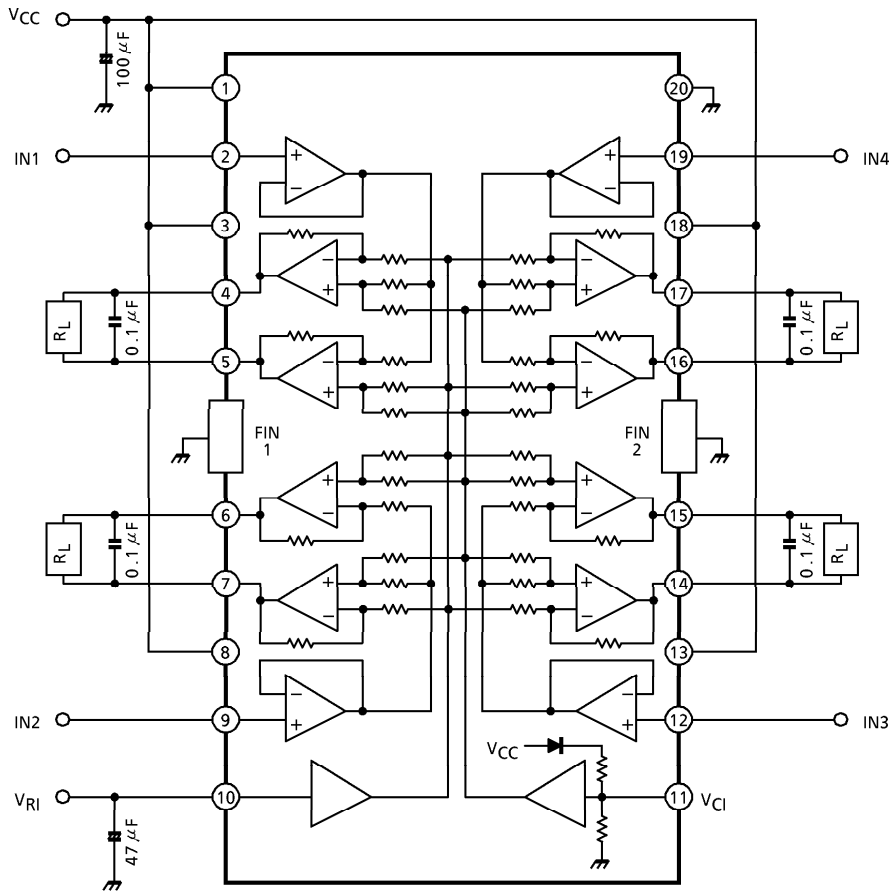

HSOP 20 POWER DISSIPATION

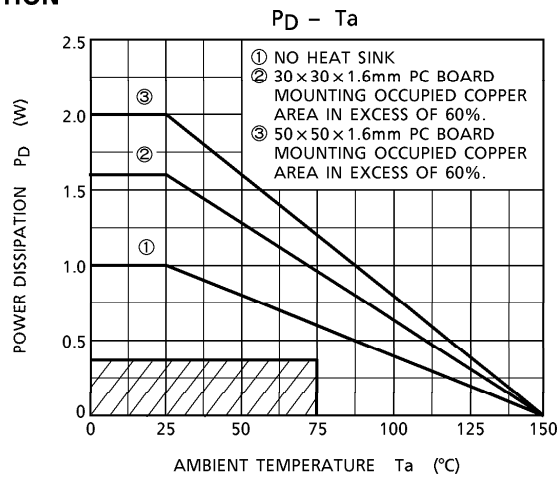

(Note) In case of normal use, power dissipation of IC only is oblique line portion.

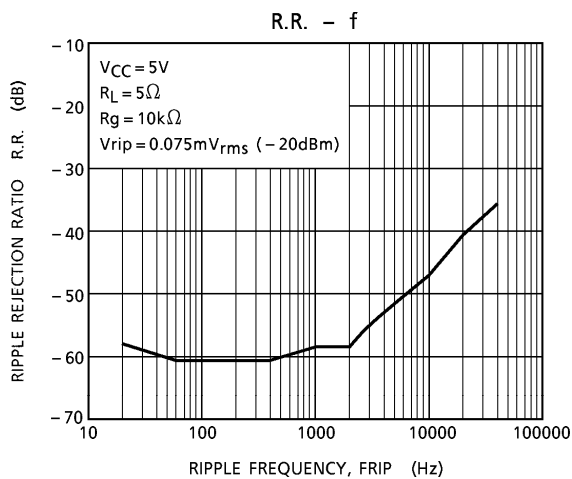
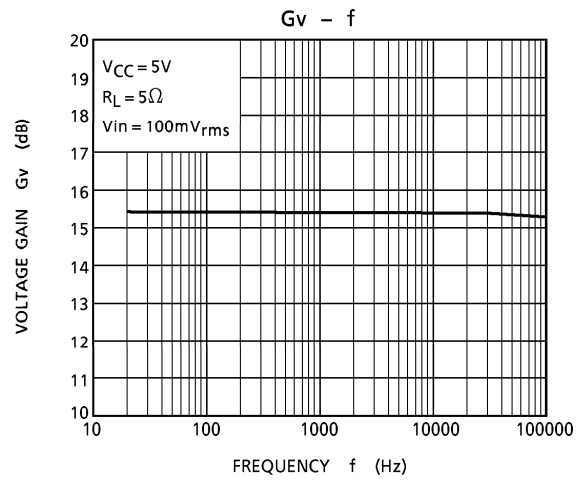
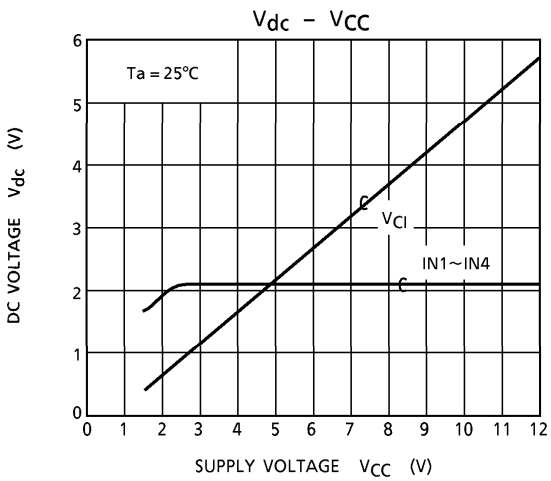
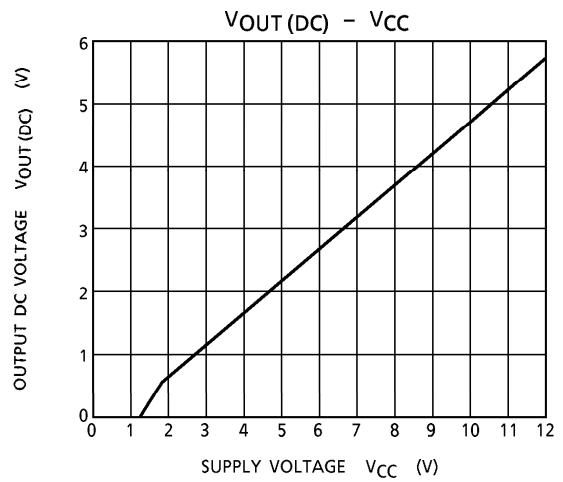
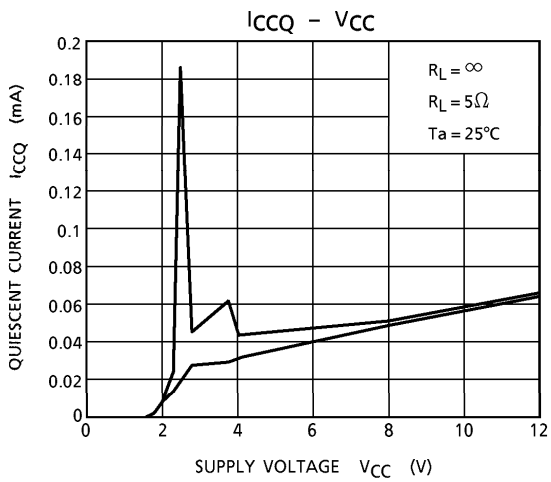

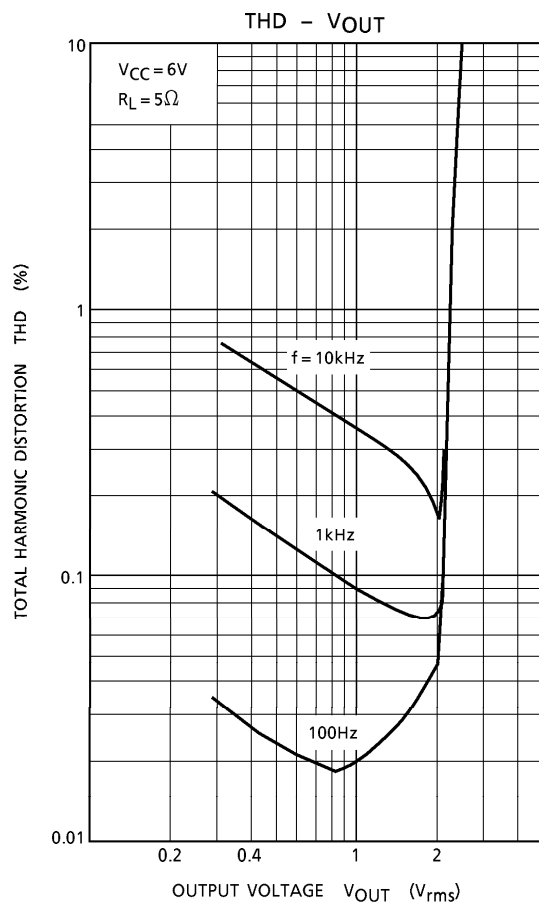
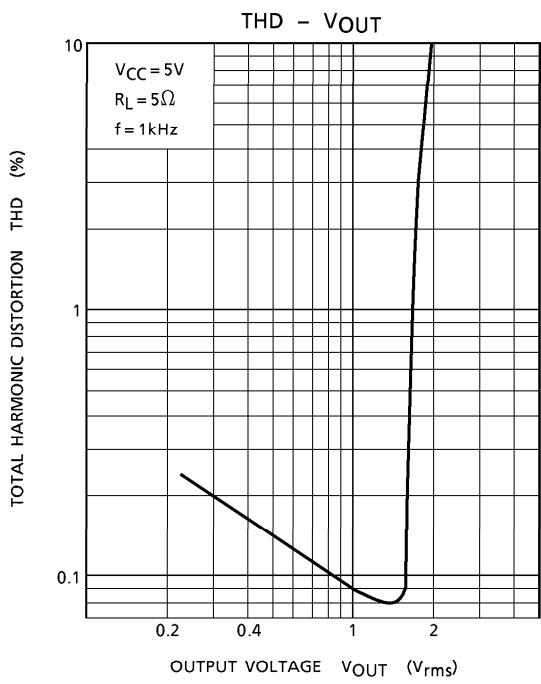

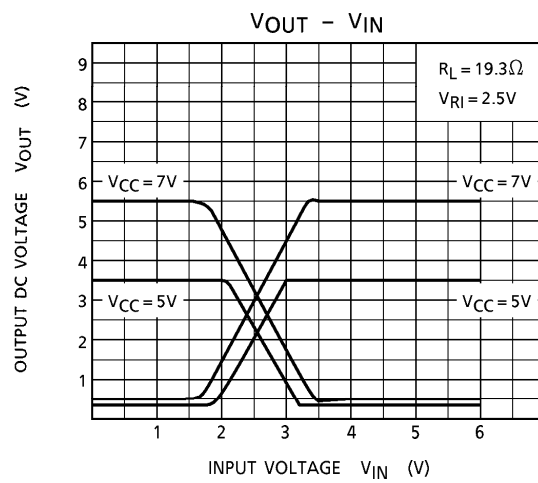
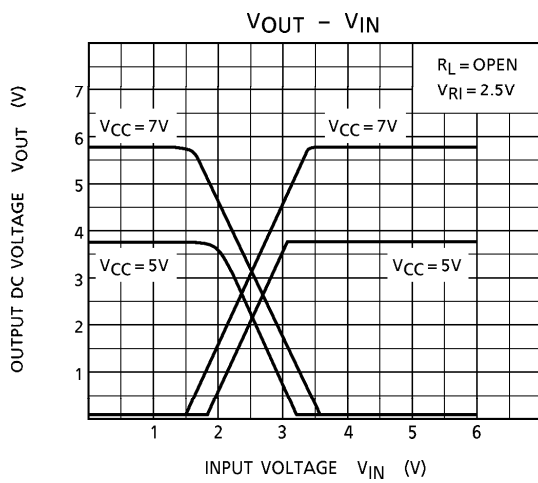
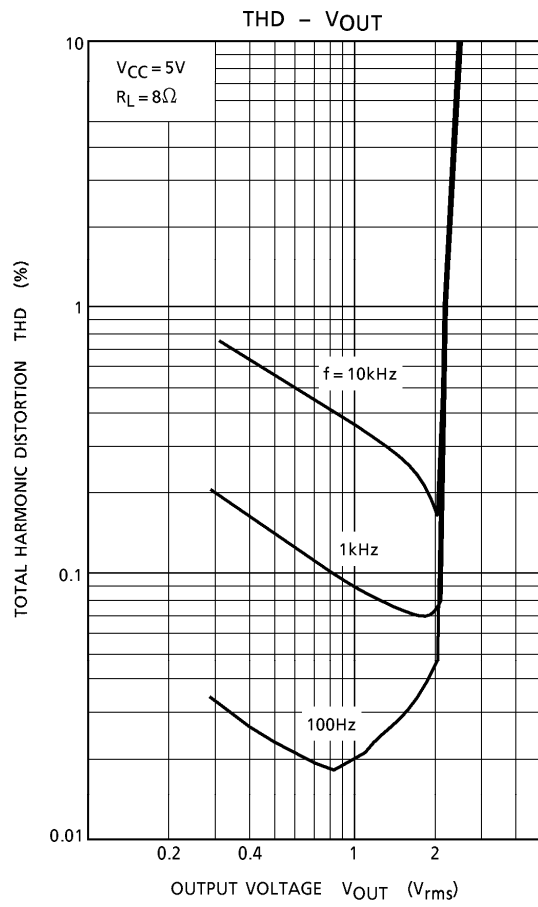
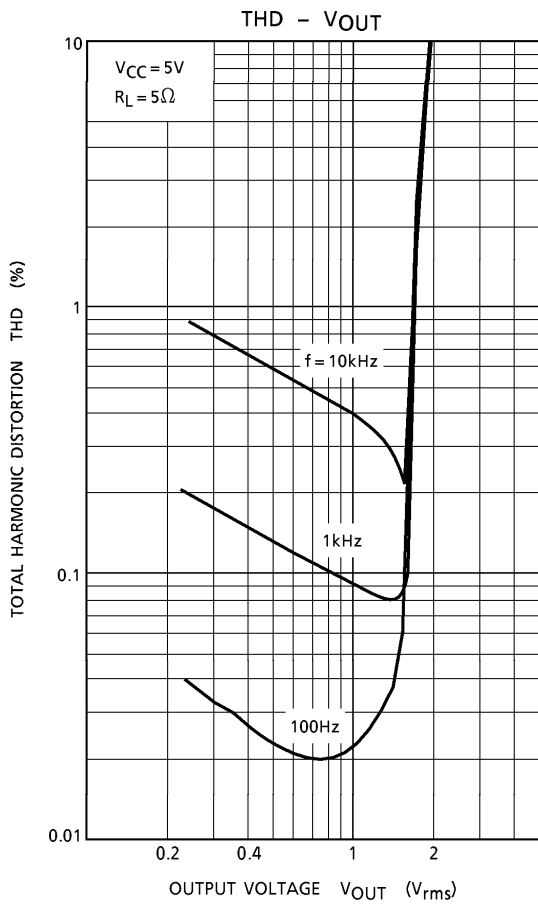

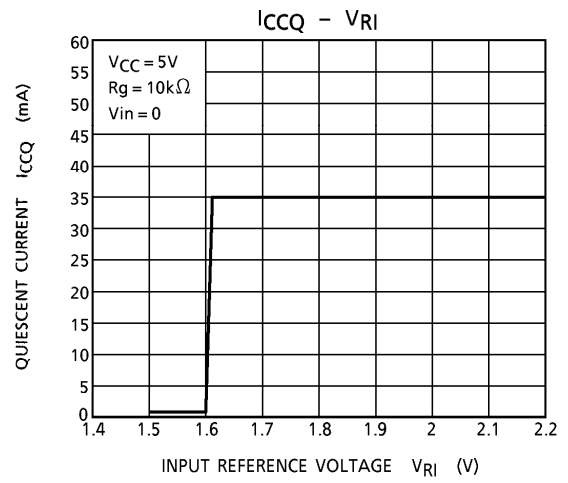
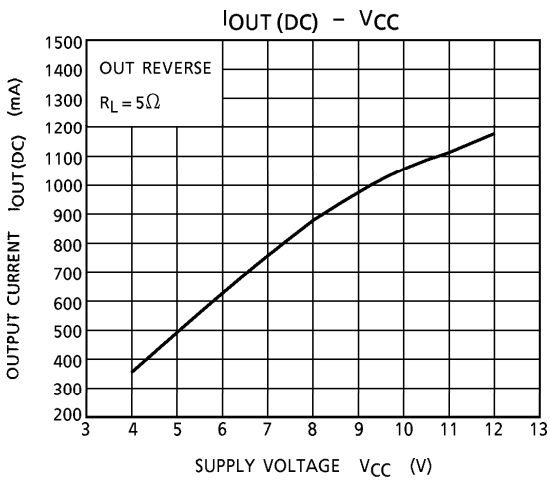
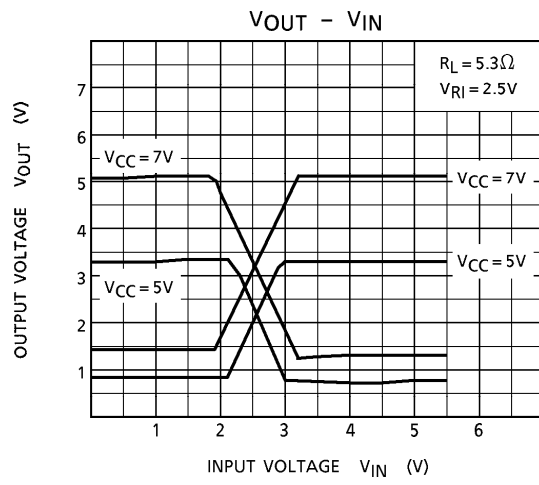
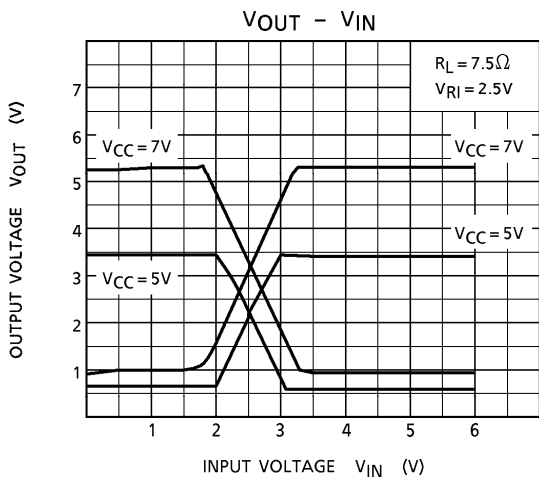

PRECAUTION USE

- Input Stage
 - Input stages are consisted of differential circuit of NPN Tr, and have built-in IB compensation circuit.
- Built-in Driver
 - Each channel driver consists of BTL configuration linear amplifier.
 - Voltage gain is fixed : $G_V = 15.5\text{dB}$ (Typ.)
 - Voltage loss for output stage is $2V_{BE} + V_{CE}(\text{sat})$ for positive cycle, $V_{CE}(\text{sat})$ for negative cycle, because of no-bootstrap circuit. So, output DC voltage is designed as less than $1/2V_{CC}$.
- V_{RI} Terminal
 - V_{RI} is reference voltage terminal for input signal.
 - If reference voltage from servo IC drop less than 1.8V, protection circuit operates and shut off bias circuit inside. This operation is to prevent load from moving undesirably in case of V_{RI} drop for accident or some reason.
- V_{CI} Terminal
 - Output DC voltage is determined by circuit of this terminal inside as ;
$$V_{CI} = V_{OUT}(\text{DC}) = (V_{CC} - V_F) / 2$$
 - Output signal dynamic range is depend on V_{CC} . On the other hand, input signal dynamic range is determined by V_{RI} as mentioned and voltage gain is fixed inside. So, maximum output voltage does not increase as V_{CC} increases.
 - Because of BTL configuration, Ripple Rejection Ratio does not improve not much when capacitor is connected to V_{CI} terminal to GND.
- GND
 - Large signal GND is for output stage and small signal GND is for stages from input circuit to pre-output stage.
 - These GND pins are not connected inside.
 - Pin① and Pin② are connected to Bedflame, and it is connected to substrate.
 - It is advised that you make a Printed Board layout of small signal GND and large signal GND should be isolated each other.
- Oscillation preventive capacitor
 - We recommend to use the capacitor of $0.1\mu\text{F}$, between each output terminals. But perform the temperature test to check the oscillation allowance, since the oscillation allowance is varied according to the causes described below.
 - 1) Supply voltage
 - 2) Ambient temperature
 - 3) Load impedance
 - 4) Capacity value of condenser
 - 5) Kind of condenser
 - 6) Layout of Printed board
- We recommend to connect Pass-condenser, which is about 10 to $100\mu\text{F}$ between V_{RI} terminal and GND.
- V_{CI} terminal is recommend to use "OPEN".

OUTLINE DRAWING
HSOP20-P-450-1.00

Unit : mm

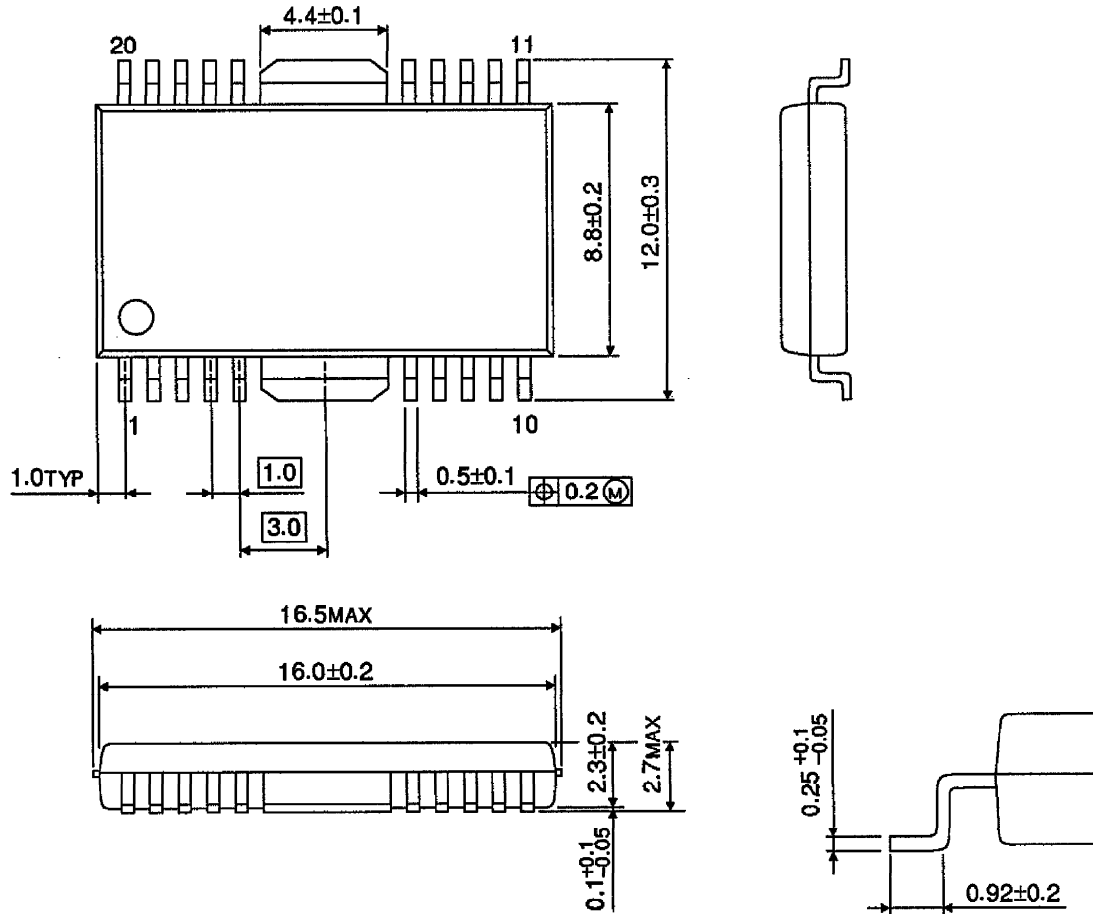

Weight : 0.8g (Typ.)