

PRODUCT SPECIFICATION

<p>COSMO ELECTRONICS CO., LTD.</p>	<p>PHOTO MOS RELAYS: KAQW614S</p>	<p>SHEET 1 OF 10</p>
---	--	----------------------

• OUTSIDE DIMENSION :

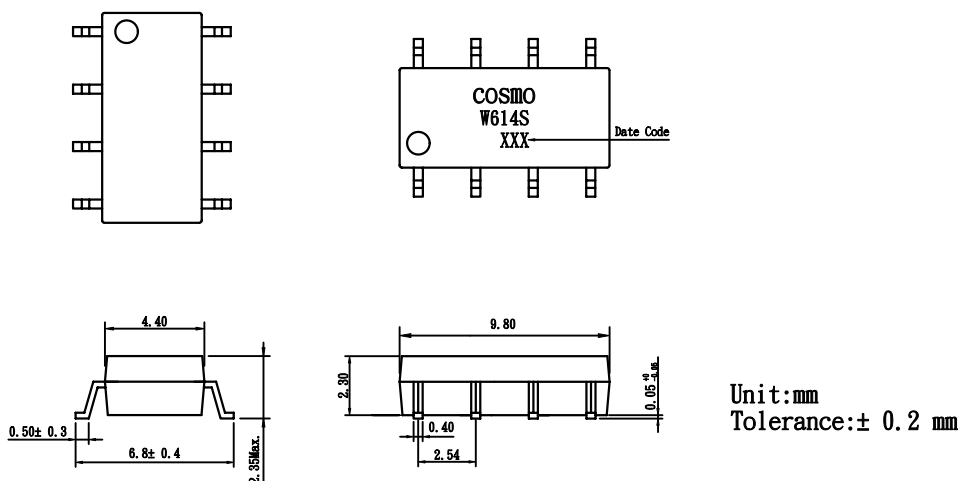

• Turn on/Turn off time

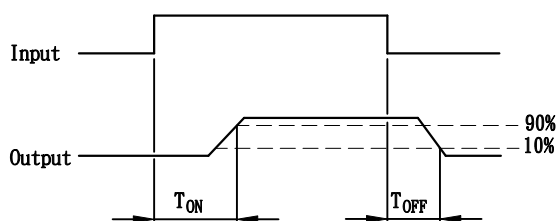

• Operate/Reverse time

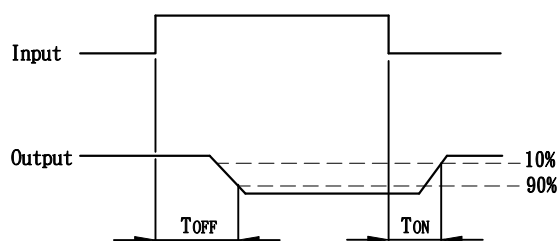

Absolute Maximum Ratings ($T_A=25^\circ\text{C}$)

Emitter (Input)

Reverse Voltage	5.0V
Continuous Forward Current	50mA
Peak Forward Current (1s)	1A
Power Dissipation	100mW
Derate Linearly from 25°C	$1.3\text{mW}/^\circ\text{C}$

Detector (Output)

Output Breakdown Voltage	$\pm 400\text{V}$
Continuous Load Current	$\pm 130\text{mA}$
Power Dissipation	500mW

General Characteristics

Isolation Test Voltage	1500VAC _{RMS}
Isolation Resistance	
$V_{10}=500\text{V}, T_A=25^\circ\text{C}$	$\geq 10^{10}\Omega$
Total Power Dissipation	550mW

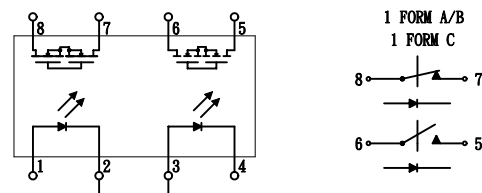

Derate Linearly form 25°C	$2.5\text{mW}/^\circ\text{C}$
Storage Temperature Range	-40 to $+150^\circ\text{C}$
Operating Temperature Range	-40 to $+85^\circ\text{C}$
Junction Temperature	100°C
Soldering Temperature, 2mm from case, 10 sec. 260°C	

PRODUCT SPECIFICATION

COSMO ELECTRONICS CO., LTD.	PHOTO MOS RELAYS: KAQW614S	SHEET 2 OF 10
---------------------------------------	--------------------------------------	---------------

Characteristics

(T_A = 25° C)

Description	Symbol	Min.	Typ.	Max.	Unit	Test Condition
Emitter (Input)						
Forward Voltage	V _F		1.8	2.0	V	I _F = 10mA
Operation Input Current	I _{FON(N.O)} I _{FOFF(N.C)}			5	mA	V _L = ± 20V, I _L = 100mA(N.O) V _L = ± 20V, I _L < 5uA(N.C) t = 10 ms
Recovery Input Current	I _{FOFF(N.O)} I _{FON(N.C)}	0.2			mA	V _L = ± 20V, I _L < 5uA(N.O) V _L = ± 20V, I _L = 100mA(N.C) t = 10 ms
Deterctor (Output) normally open						
Output Breakdown Voltage	V _B	400			V	I _B = 50uA
Output Off-State Leakage	I _{T(OFF)}		0.2	1	uA	V _T = 100V, I _F = 0mA
I/O Capacitance	C _{ISO}		6		pF	I _F = 0, f = 1MHz
ON Resistance	R _{ON}		20	30	Ω	I _L = 100mA, I _F = 10mA
Turn-on Time	T _{ON}		0.3	1.0	ms	I _F = 10mA, V _L = ± 20V
Turn-off Time	T _{OFF}		0.7	1.5	ms	t = 10ms, I _L = ± 100mA

Deterctor (Output) normally close						
Output Breakdown Voltage	V _B	400			V	I _B = 50uA
Output Off-State Leakage	I _{T(OFF)}		0.2	1	uA	V _T = 100V, I _F = 0mA
I/O Capacitance	C _{ISO}		6		pF	I _F = 0, f = 1MHz
ON Resistance	R _{ON}		40	50	Ω	I _L = 100mA, I _F = 0mA
Reverse(ON) Time	T _{ON}		0.6	1.5	ms	I _F = 10mA, V _L = ± 20V
Operate(OFF) Time	T _{OFF}		0.3	1.0	ms	t = 10ms, I _L = ± 100mA

Mos Relay Schematic and Wiring Diagrams

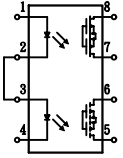
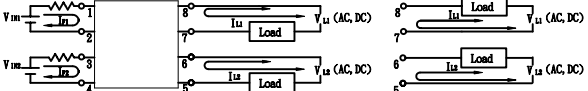
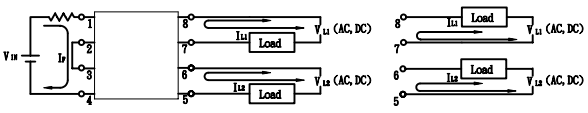
Type	Schematic	Output configuration	Load	Con-nection	Wiring diagram
KAQW614S		1a1b	AC/DC	-	<p>(1) Two independent 1 Form A & 1 Form B use</p>  <p>(2) 1 Form A 1 Form B use</p> 

PRODUCT SPECIFICATION

COSMO

ELECTRONICS CO., LTD.

PHOTO MOS RELAYS:

KAQW614S

SHEET 3 OF 10

Normally Open Characteristics DATA CURVE

Load current vs. ambient temperature
Allowable ambient temperature:
-40° C+85° C

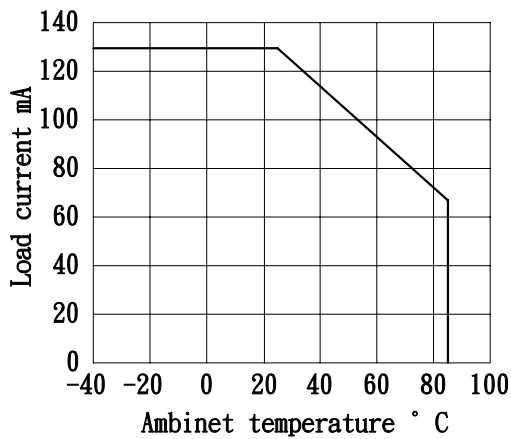

On resistance vs. ambient temperature
Across terminals 5 and 6 pin
LED current: 5mA
Continuous load current: 130 mA(DC)

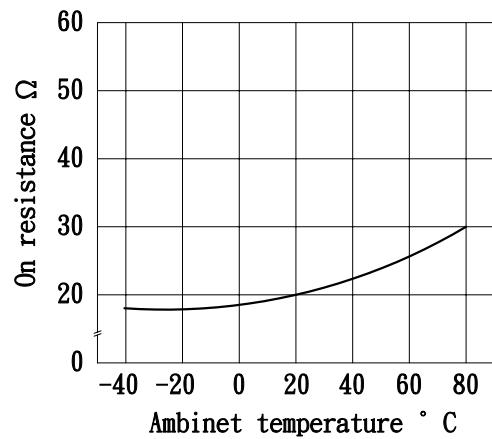

Turn on time vs. ambient temperature
Load voltage 400 V(DC)
LED current :5mA
Continuous load current: 130mA(DC)

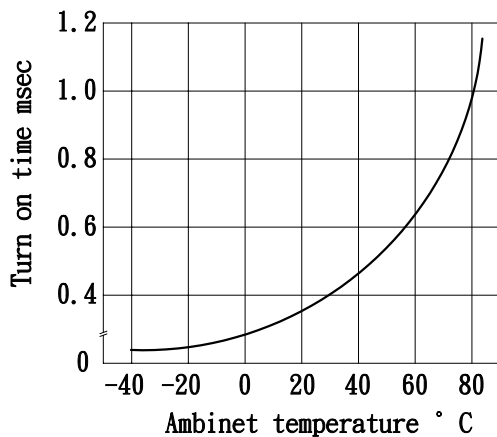

Turn off time vs. ambient temperature
LED current: 5mA;Load voltage: 400V(DC)
Continuous load current: 130mA(DC)

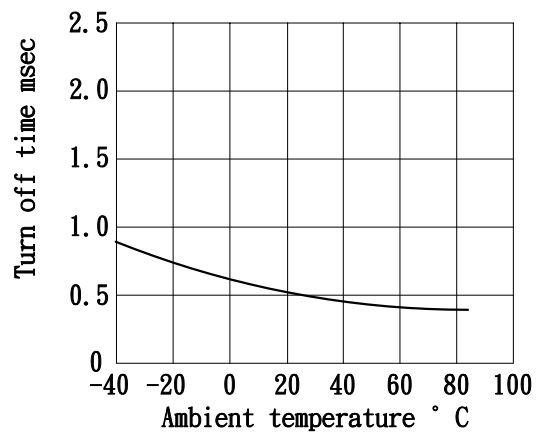

PRODUCT SPECIFICATION

<p>COSMO ELECTRONICS CO., LTD.</p>	<p>PHOTO MOS RELAYS: KAQW614S</p>	<p>SHEET 4 OF 10</p>
---	--	----------------------

LED operate vs. ambient temperature
Load voltage: 400V(DC)
Continuous load current: 130mA(DC)

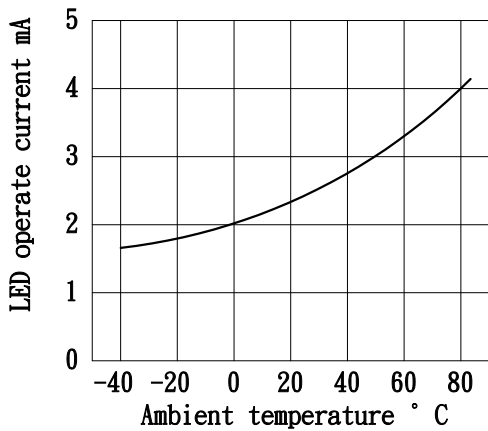

LED turn off current vs. ambient temperature
Load voltage: 400V(DC)
Continuons load current: 130mA(DC)

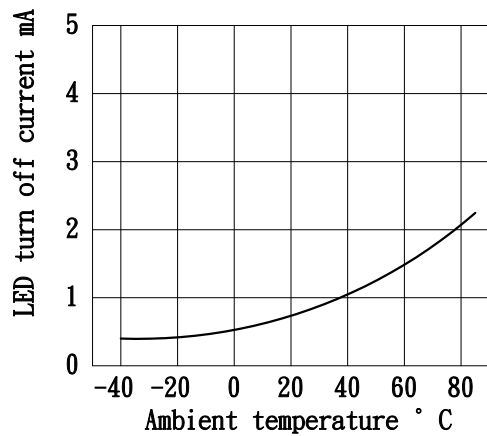

LED dropout voltage vs. ambient temperature
LED current: 5 to 50mA

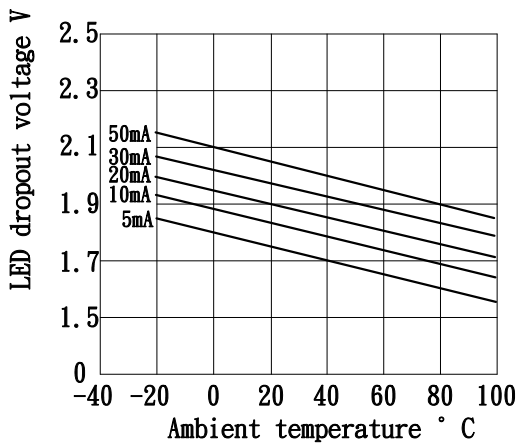

Voltage vs. current characteristics of output at MOS FET portion
Measured portion: across terminals 5 and 6 pin
Ambient temperature: 25° C

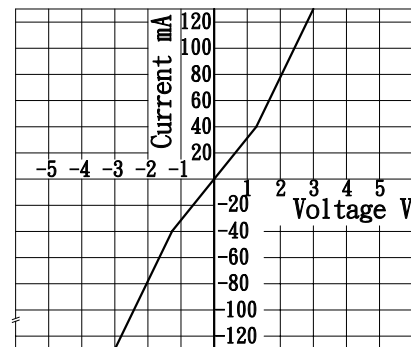

PRODUCT SPECIFICATION

COSMO

ELECTRONICS CO., LTD.

PHOTO MOS RELAYS:

KAQW614S

SHEET 5 OF 10

LED forward current vs. turn on time
Across terminals 5 and 6pin; Load voltage: 400V(DC); Continuous load current: 130mA(DC); Ambient temperature: 25° C

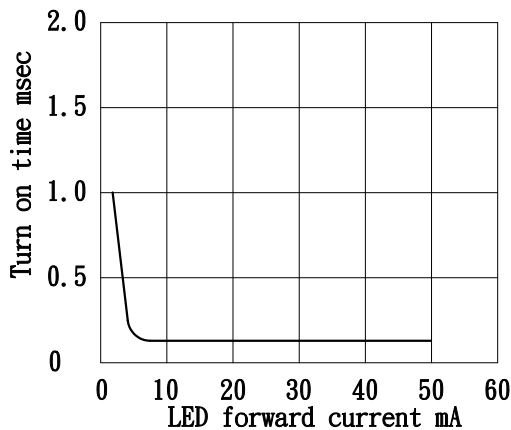

Off state leakage current
Across terminals 5 and 6pin
Ambient temperature: 25° C

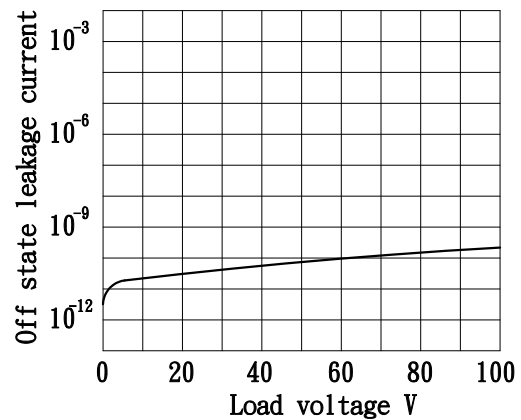

LED forward current vs. turn off time
Across terminals 5 and 6pin; Load voltage: 400V(DC); Continuous load current: 130 mA(DC); Ambient temperature: 25° C

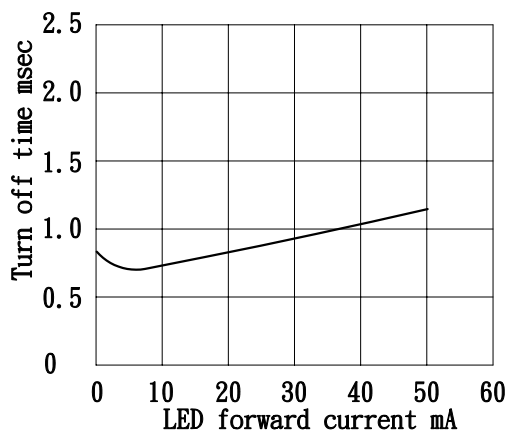

Applied voltage vs. output capacitance
Across terminals 5 and 6pin
Frequency: 1MHz; Ambient temperature: 25° C

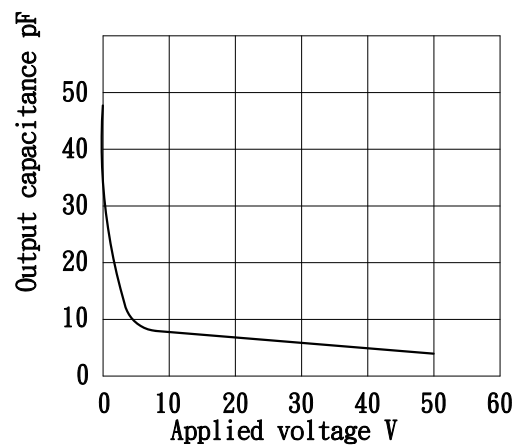

PRODUCT SPECIFICATION

<p>COSMO ELECTRONICS CO., LTD.</p>	<p>PHOTO MOS RELAYS: KAQW614S</p>	<p>SHEET 6 OF 10</p>
---	--	----------------------

Normally Close Characteristics DATA CURVE

Load current vs. ambient temperature
Allowable ambient temperature:
-40° C+85° C

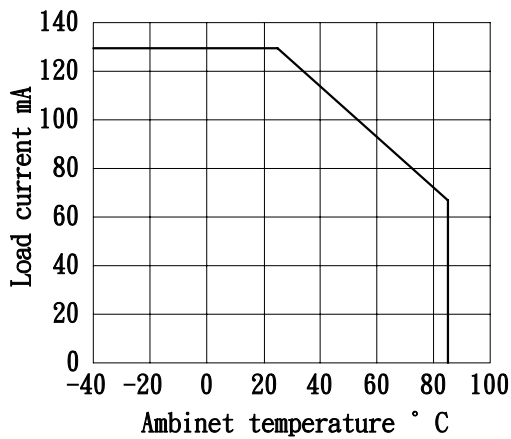

On resistance vs. ambient temperature
Across terminals 7 and 8 pin
LED current: 0mA
Continuous load current: 130 mA(DC)

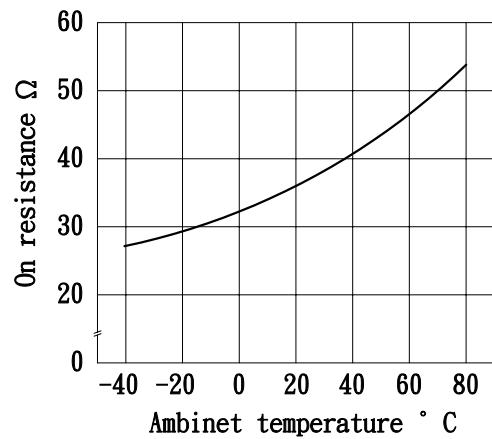

Operate(OFF) time vs. ambient temperature
Load voltage 400 V(DC)
LED current :5mA
Continuous load current: 130mA(DC)

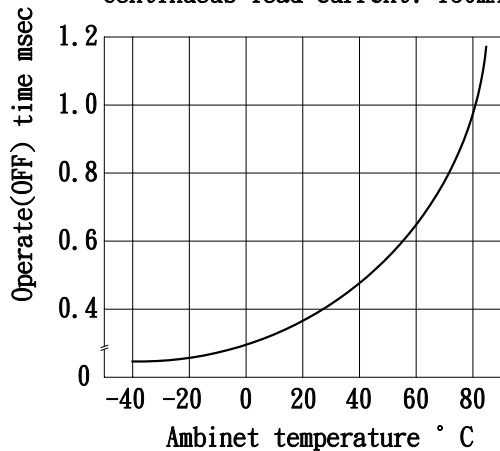

Reverse(ON) time vs. ambient temperature
LED current: 5mA;Load voltage: 400V(DC)
Continuous load current: 130mA(DC)

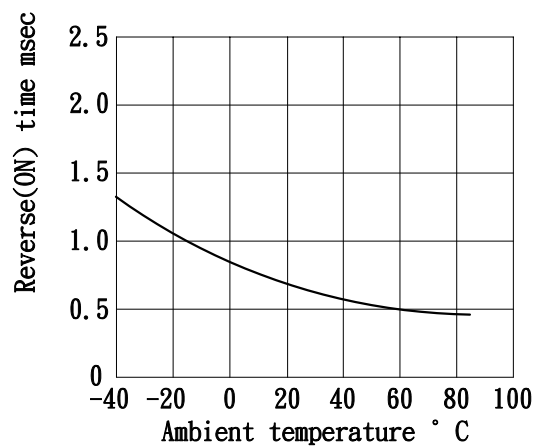

PRODUCT SPECIFICATION

<p>COSMO ELECTRONICS CO., LTD.</p>	<p>PHOTO MOS RELAYS: KAQW614S</p>	<p>SHEET 7 OF 10</p>
---	--	----------------------

LED operate(OFF) vs. ambient temperature
Load voltage: 400V(DC)
Continuous load current: 130mA(DC)

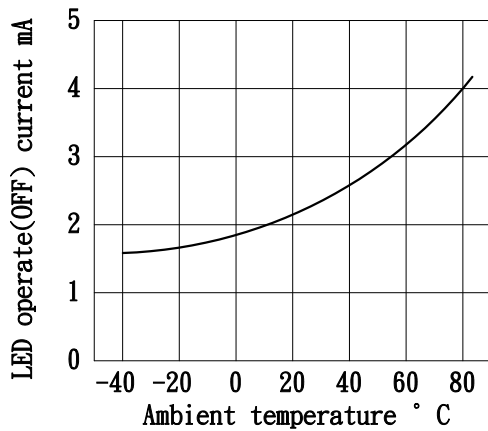

LED reverse(ON) current vs. ambient temperature
Load voltage: 400V(DC)
Continuons load current: 130mA(DC)

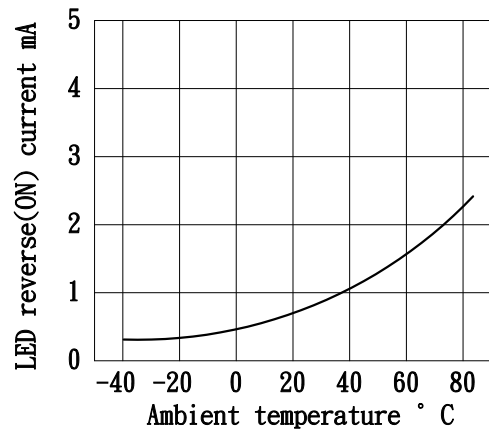

LED dropout voltage vs. ambient temperature
LED current: 5 to 50mA

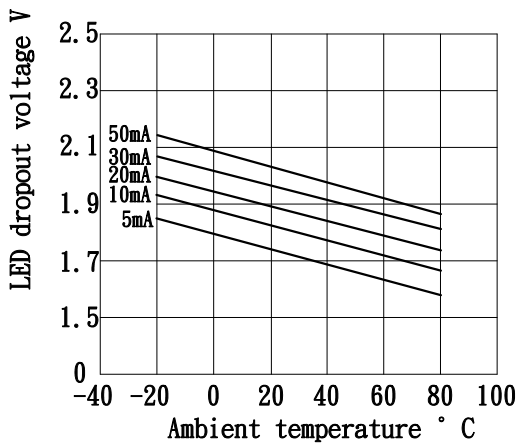

Voltage vs. current characteristics of output at MOS FET portion
Measured portion: across terminals 7 and 8 pin
Ambient temperature: 25° C

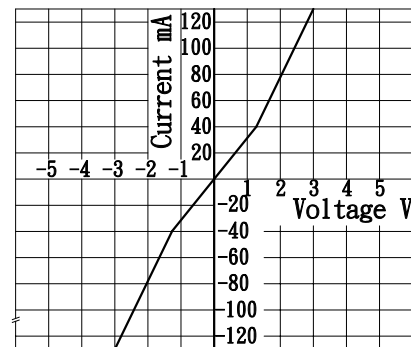

PRODUCT SPECIFICATION

<p>COSMO ELECTRONICS CO., LTD.</p>	<p>PHOTO MOS RELAYS: KAQW614S</p>	<p>SHEET 8 OF 10</p>
---	--	----------------------

LED forward current vs. Operate(OFF) time
Across terminals 7 and 8pin; Load voltage:
400V(DC); Continuous load current: 130mA(DC)
; Ambient temperature: 25° C

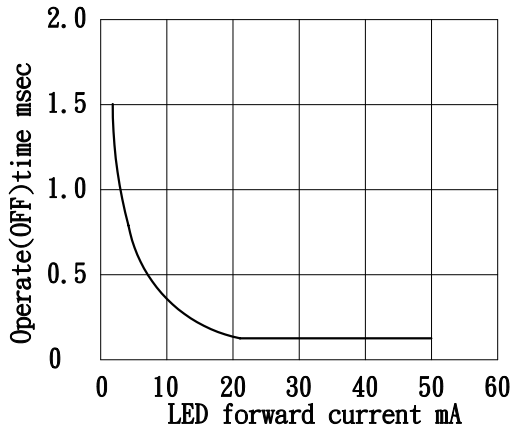

Off state leakage current
Across terminals 7 and 8pin
Ambient temperature: 25° C

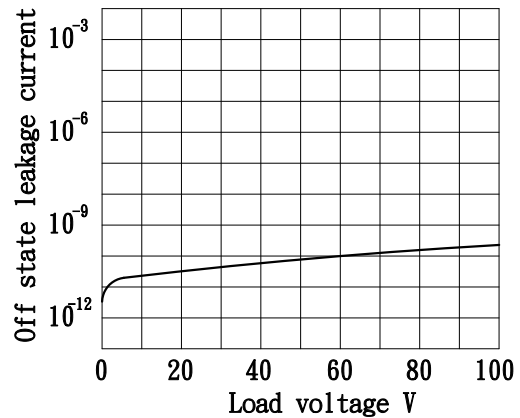

LED forward current vs. reverse(ON) time
Across terminals 7 and 8pin; Load vol-
tage: 400V(DC); Continuous load current:
130 mA(DC); Ambient temperature: 25° C

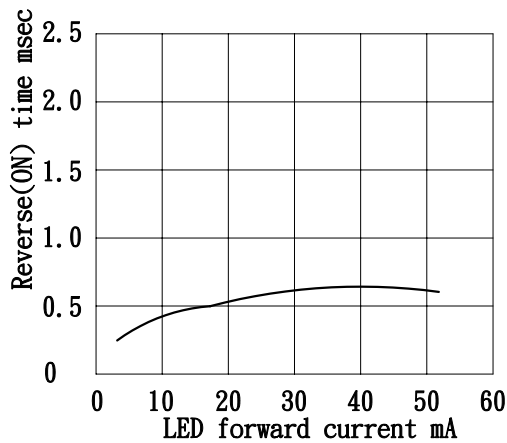

Applied voltage vs. output capacitance
Across terminals 7 and 8pin
Frequency: 1MHz; Ambient temperature:
25° C

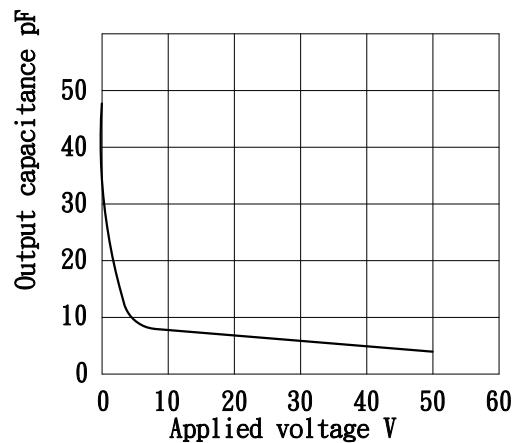

PRODUCT SPECIFICATION

COSMO ELECTRONICS CO., LTD.	PHOTO MOS RELAYS: KAQW614S	SHEET 9 OF 10
---------------------------------------	--------------------------------------	---------------

USING METHODS

Examples of resistance value to control LED forward current I_F

Photo MOSRELAY

($I_F = 5\text{mA}$)

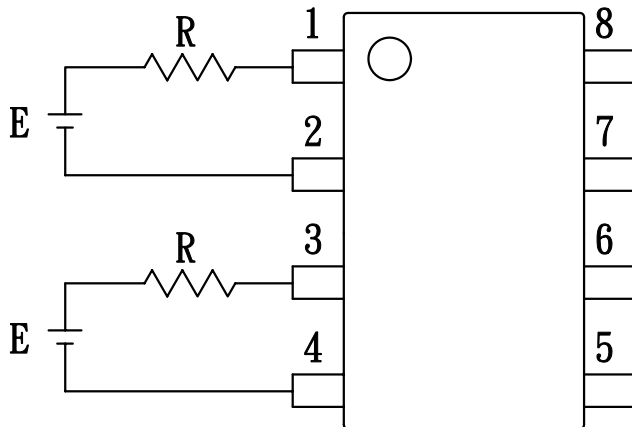

E	R
3.3V	Approx. 240 ohm
5V	Approx. 540 ohm
12V	Approx. 1.8K ohm
15V	Approx. 2.4K ohm
24V	Approx. 4K ohm

- (1) LED forward current must be more than 5mA, at E min.
- (2) LED forward current must be less than 50mA, at E max.

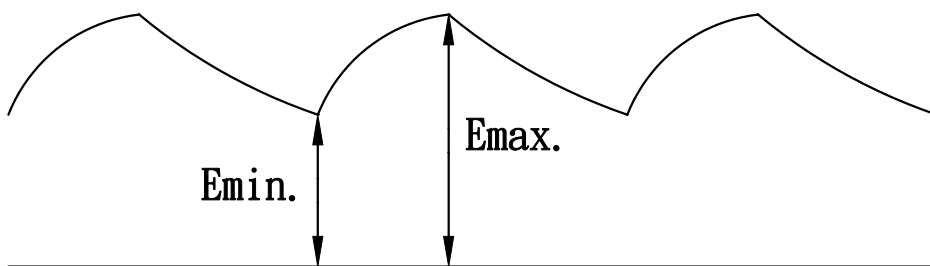

PRODUCT SPECIFICATION

COSMO ELECTRONICS CO., LTD.	PHOTO MOS RELAYS: KAQW614S	SHEET 10 OF 10
---------------------------------------	--------------------------------------	----------------

USING METHODS

Regulate the spike voltage generated on the inductive load as follows

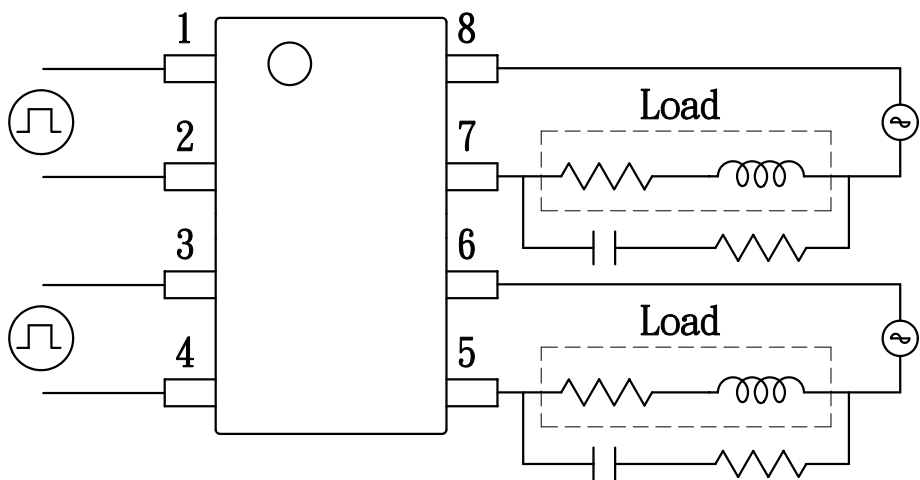
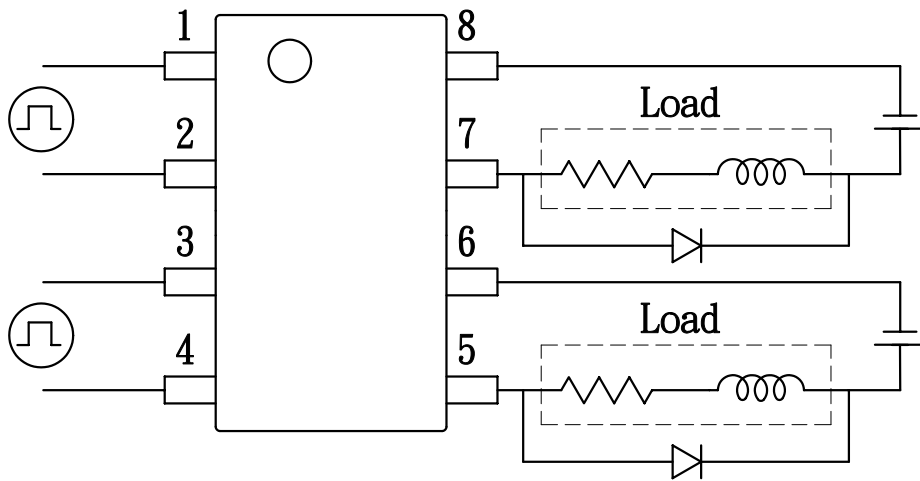

R-C Snubber