

SANYO	No. 3231C	LA1851N
	DTS Single-chip Tuner IC	

Overview

The LA1851N is a tuner IC designed for home-use stereo equipment which supports the SD system and IF counter system and incorporates AM/FM IF/MPX functions on a single chip.

Features

- AM/FM tuner and multiplex demodulator on a single chip
- No multiplexer adjustments required
- Output (FM/AM) for IF counter buffer compatible with electronic tuning
- Stereo separation control
- Forced monaural and VCO stop functions
- Minimal multiplexer carrier leakage
- Excellent VCO temperature characteristics: $f_o = 0.1\%$ typ. with ± 50 deg. variation

Functions

[FM Block]

- IF amplifier
- S-meter output
- Quadrature detector
- Tuner indicator (variable sensitivity)
- IF counter buffer

[AM Block]

- RF amplifier
- IF amplifier
- IF counter buffer
- Mixer
- Detector
- Tuner indicator (variable sensitivity)
- Oscillator
- AGC
- Oscillator buffer

[MPX Block]

- PLL decoder
- Separation control
- ST indicator
- No VCO adjustment
- VCO stop
- Forced monaural (VCO stop)
- Mute

Package Dimensions

unit : mm

3196-DIP30SD

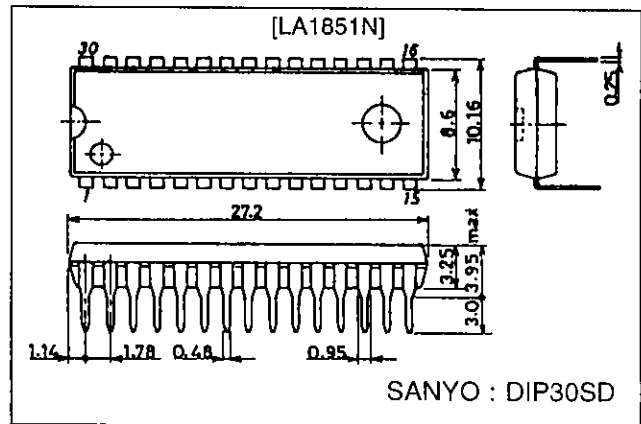

Specifications

Maximum Ratings at $T_a = 25^\circ\text{C}$

Parameter	Symbol	Conditions	Ratings	Unit
Maximum supply voltage	$V_{CC \text{ max}}$	Pins 3, 7, 10, 21, 22 and 26	14	V
Maximum supply current	$I_{CC \text{ max}}$	Pin 3	40	mA
		Pins 21 and 22	20	mA
Allowable power dissipation	$P_d \text{ max}$	$T_a = 70^\circ\text{C}$	480	mW
Operating temperature	T_{opr}		-20 to +70	$^\circ\text{C}$
Storage temperature	T_{stg}		-40 to +125	$^\circ\text{C}$

LA1851N

Operating Conditions at Ta = 25 °C

Parameter	Symbol	Conditions	Ratings	Unit
Recommended supply voltage	V _{CC}		8.5	V
Operating supply voltage range	V _{CC op}		6 to 12	V

Operating Characteristics at Ta = 25°C, V_{CC} = 8.5 V

Parameter	Symbol	Conditions	min	typ	max	Unit
[AM: f _{in} = 1 MHz, 1 kHz tone]						
Quiescent current	I _{CCO}	No input		26	37	mA
Detector output	V _{O1}	V _{IN} = 23 dBμ, 30% AM	70	140	260	mV
	V _{O2}	V _{IN} = 80 dBμ, 30% AM	170	280	390	mV
Signal-to-noise ratio	S/N1	V _{IN} = 23 dBμ, 30% AM	15	19		dB
	S/N2	V _{IN} = 80 dBμ, 30% AM	45	50		dB
Total harmonic distortion	THD1	V _{IN} = 80 dBμ, 30% AM		0.5	1.2	%
	THD2	V _{IN} = 100 dBμ, 30% AM		0.6	1.3	%
IF buffer output	V _{IF}	V _{IN} = 20 dBμ	110	170	230	mV
Local oscillator buffer output	V _{Osc}	f _{Osc} = 1.450 MHz	290	350	420	mV
Tuner turn-on sensitivity	V _S	Variable sensitivity		(13)		dBμ
[FM mono: f _{in} = 10.7 MHz, 1 kHz tone]						
Quiescent current	I _{CCO}	No input		27	38	mA
Input limiting sensitivity	LMS	3 dB down, 100% FM		32	38	dBμ
Demodulation output	V _O	V _{IN} = 100 dBμ, 100% FM	380	560	750	mV
Signal-to-noise ratio	S/N	V _{IN} = 100 dBμ	71	77		dB
Amplitude modulation rejection ratio	AMR	V _{IN} = 100 dBμ, 30% AM, 1 kHz tone	48	61		dB
Total harmonic distortion	THD	V _{IN} = 100 dBμ, 100% FM		0.2	1.0	%
Signal meter output	V _{SM1}	No input	0	0.1	0.3	%
	V _{SM2}	V _{IN} = 70 dBμ	0.7	1.2	1.8	V
	V _{SM3}	V _{IN} = 100 dBμ	2.1	2.9	3.3	V
IF buffer output	V _{IF}	V _{IN} = 50 dBμ	170	260	350	mV
Tuner turn-on sensitivity	V _S	Variable sensitivity		(59)		dBμ
[FM stereo: L + R = 90%, pilot = 10%, V _{IN} = 100 dBμ, f _m = 1 kHz]						
Channel separation	Sep 1K		30	45		dB
Total harmonic distortion	THD main	Stereo, main		0.3	1.0	%
Bandwidth	BW	Stereo, main	160	210	280	kHz
Channel balance	CB	Mono AM	-1.0	0	0.1	dB
Mute attenuation	ATT	Mono	67	82		dB
Lamp turn-on level	Pilot	Stereo, main	1.2	3.1	4.5	%
Lamp hysteresis	Hs	Stereo, main		(2.5)		dB

Note: Figures in parenthesis denote design guarantee values.

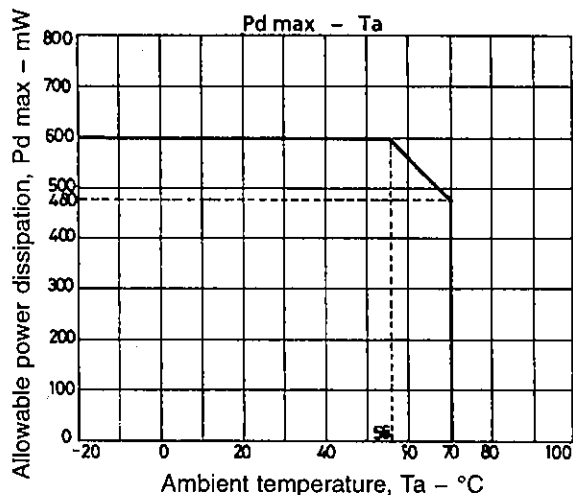

LA1851N

Test Circuit

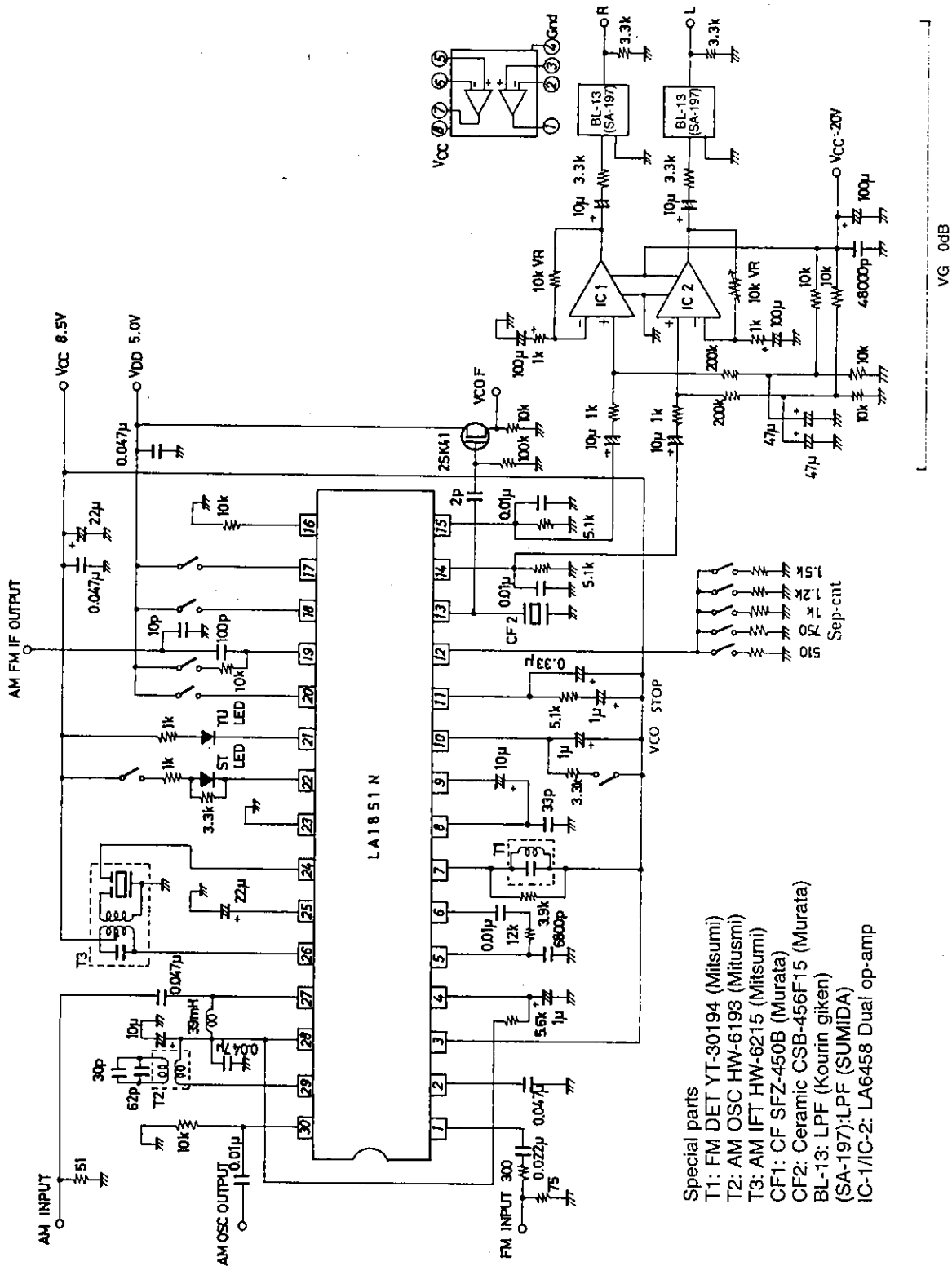

Unit (resistance: Ω, capacitance: F)

LA1851N

Test Circuit

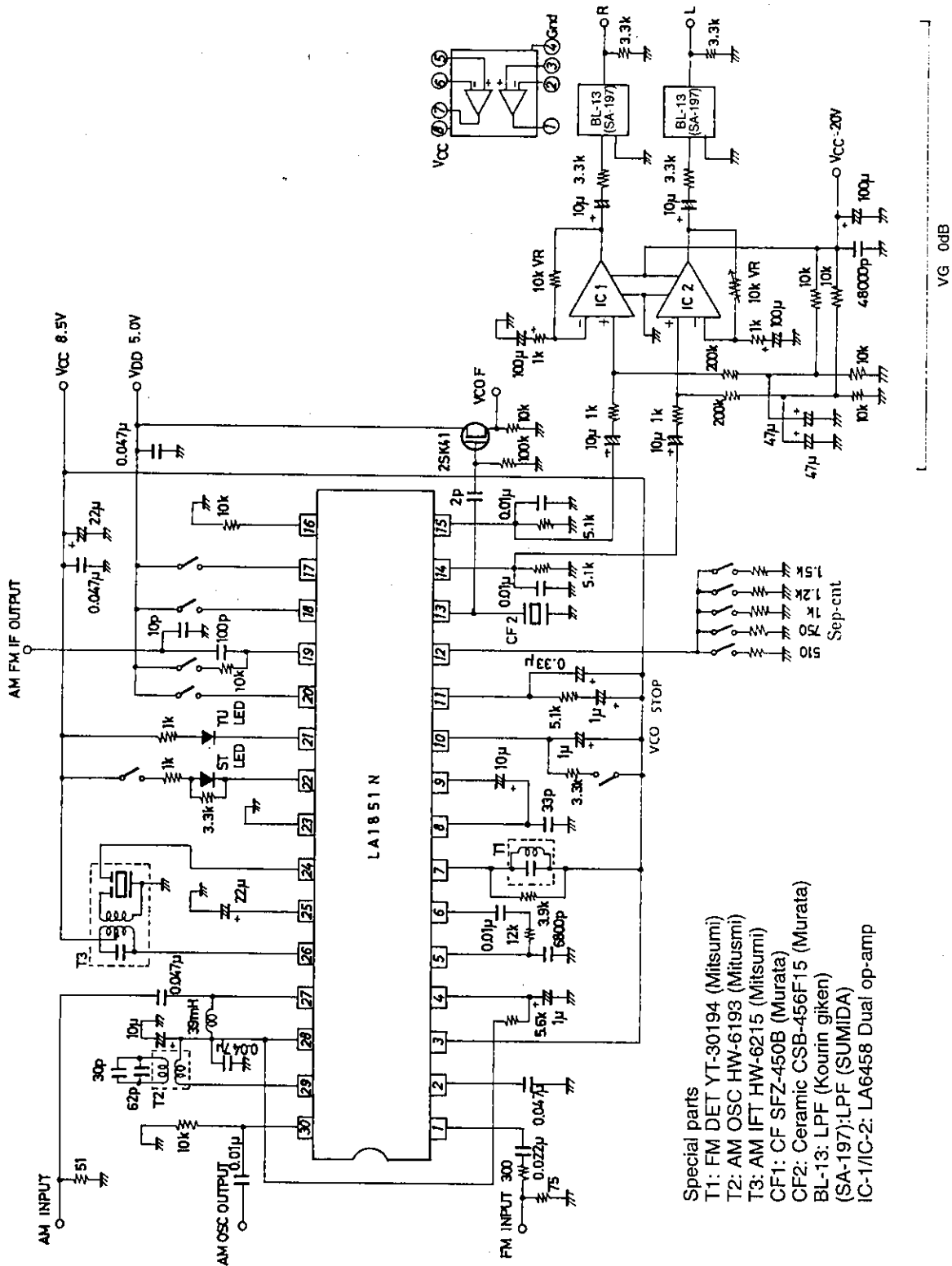

- Special parts
- T1: FM DET YT-30194 (Mitsumi)
 - T2: AM OSC HW-6193 (Mitsumi)
 - T3: AM IFT HW-6215 (Mitsumi)
 - CF1: CF SFZ-450B (Murata)
 - CF2: Ceramic CSB-456F15 (Murata)
 - BL-13: LPF (Kourin giken)
 - (SA-197): LPF (SUMIDA)
 - IC-1/IC-2: LA6458 Dual op-amp

VG 0dB

Unit (resistance: Ω, capacitance: F)

Printed Circuit Board Layout

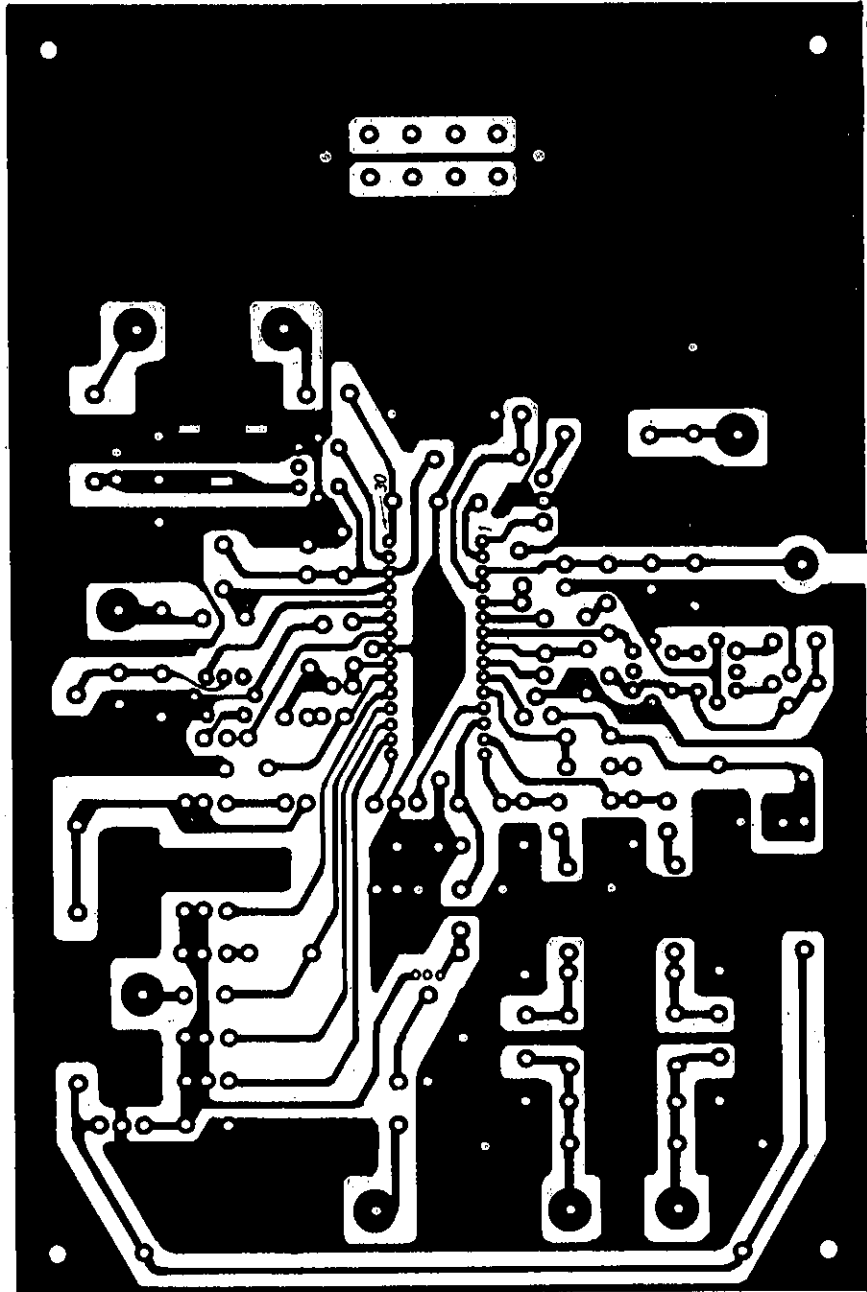

LA1851N

Pin Functions

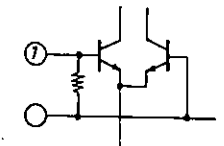
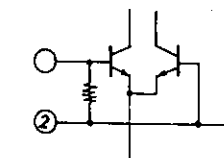
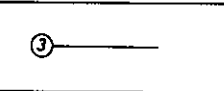
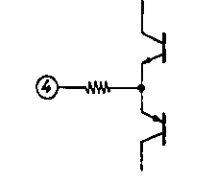
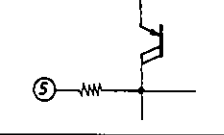
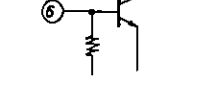
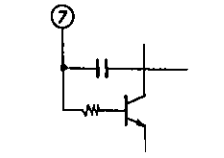
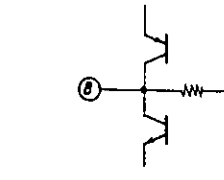
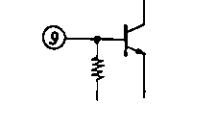
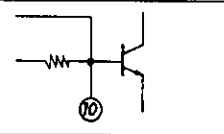
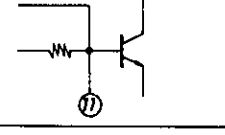
Pin no.	Function	Internal equivalent circuit	Remarks
1	FM IF input		Input impedance: 330 Ω
2	FM IF bias		
3	Vcc		
4	FM AFC output		Forced monaural mode is established in synchronization with the extinguishing of ST LED during FM AFC detuning.
5	AM demodulation output		
6	MPX AM DET input		MPX block AM demodulation input pin Input impedance: 27 k Ω
7	FM discriminator output		
8	FM demodulation output		Output impedance: 5 k Ω
9	MPX FM DET output		MPX block FM demodulation input pin Input impedance: 27 k Ω
10	MPX pilot sync detection filter		MPX VCO is stopped by shorting the V10 voltage in the V3 Vcc line. However, a 3.3 k Ω current-limiting resistor is required.
11	MPX PLL loop filter		

Continued on next page.

LA1851N

Continued from preceding page.

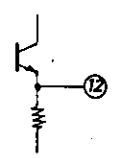
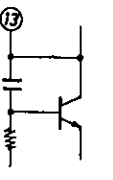
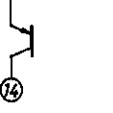
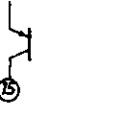
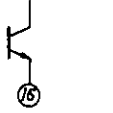
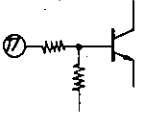
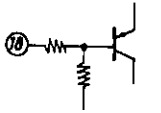
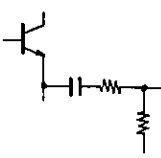
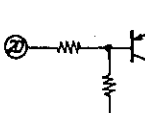
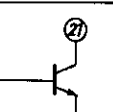
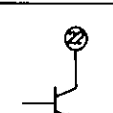
Pin no.	Function	Internal equivalent circuit	Remarks
12	MPX Separation control		
13	MPX VCO		Ceramic oscillator connection pin. CSB456F15 (Murata) recommended
14	MPX Left channel output		
15	MPX Right channel output		
16	AM SD ADJ		
17	MPX AF muting drive		$V_{HI} (\geq 1.5 \text{ V})$: Mute on $V_{LO} (< 1.5 \text{ V})$: Mute off (μ -COM direct control enabled)
18	AM/FM switch		$V_{HI} (\geq 1.5 \text{ V})$: FM $V_{LO} (< 1.5 \text{ V})$: AM (μ -COM direct control enabled)
19	AM/FM IF counter output/switch		$V_{HI} (\geq 1.5 \text{ V})$: IF CNT ON $V_{LO} (< 1.5 \text{ V})$: IF CNT OFF (μ -COM direct control enabled)
20	Forced TU/ST LED extinguishing drive pin		$V_{HI} (\geq 1.5 \text{ V})$: LED forced OFF (forced monaural mode) $V_{LO} (< 1.5 \text{ V})$: Normal (μ -COM direct control enabled)
21	AM/FM TU LED		
22	MPX ST LED		

Continued on next page.

LA1851N

Continued from preceding page.

Number	Symbol	Equivalent circuit	Description
23	AM/FM MPX GND		
24	AM IF input		Input impedance: 2 kΩ
25	AM AGC output FM S-meter output		
26	AM MIXER output		
27	AM RF input		
28	V Reg		Vreg = 2.3 V
29	AM OSC		
30	AM OSC buffer output/ FM SD ADJ		

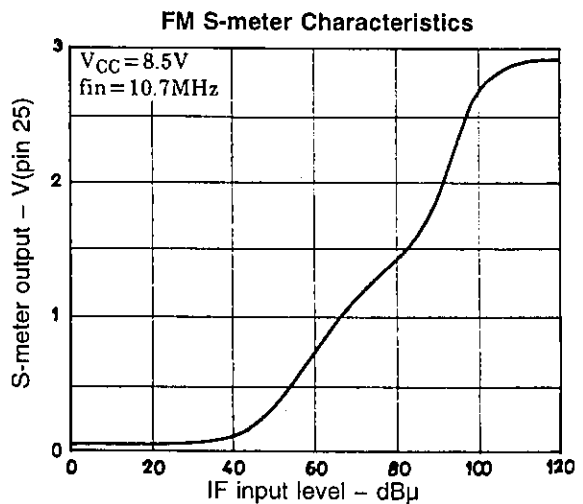
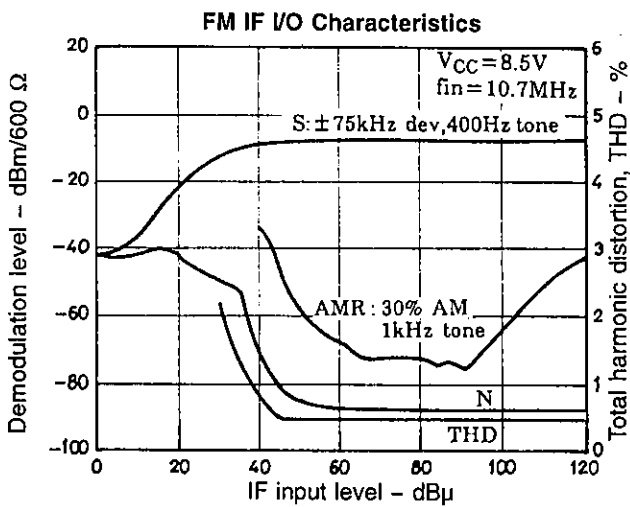

LA1851N

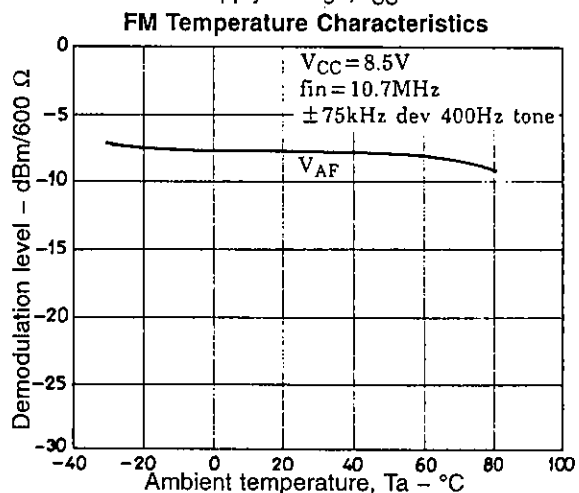
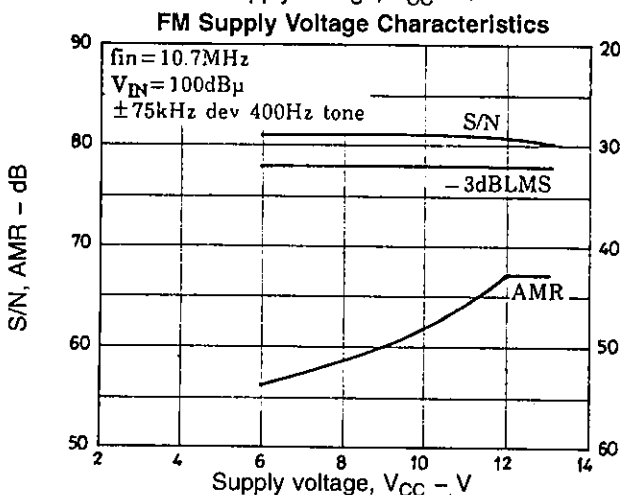
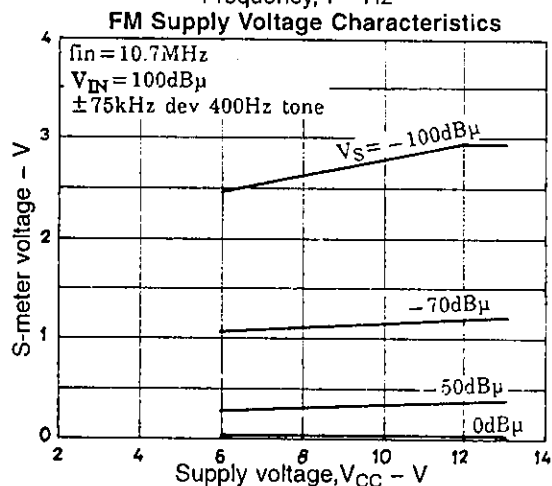
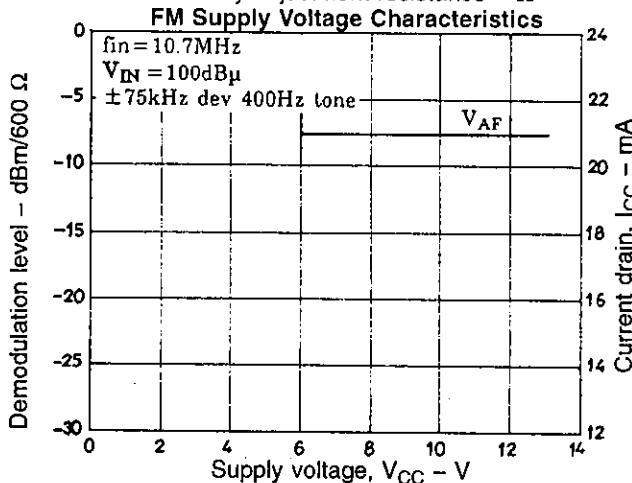
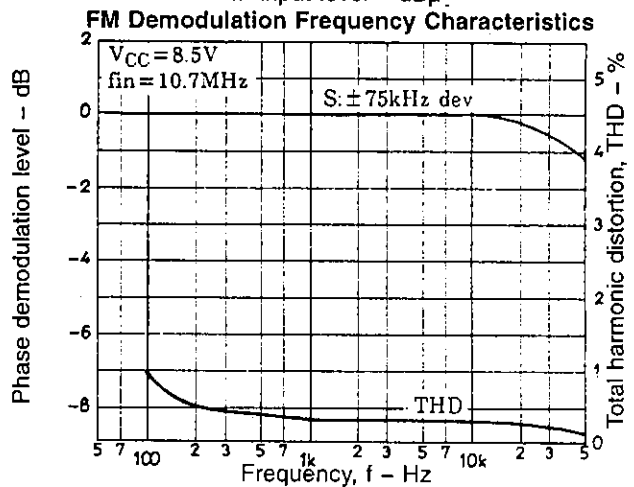
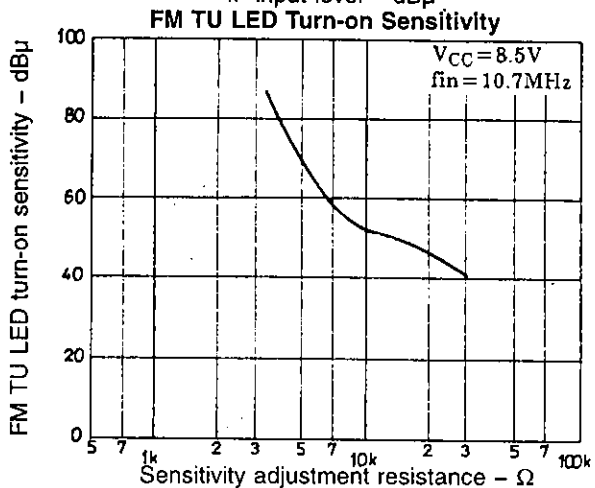
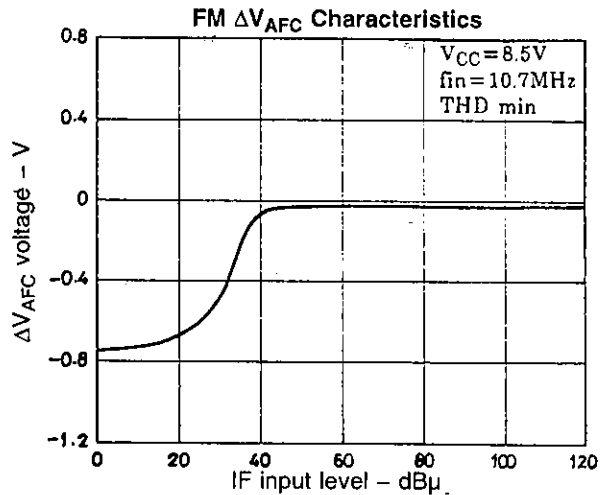
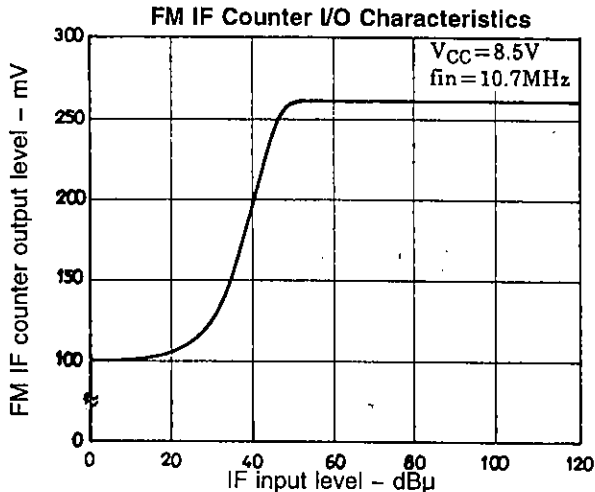

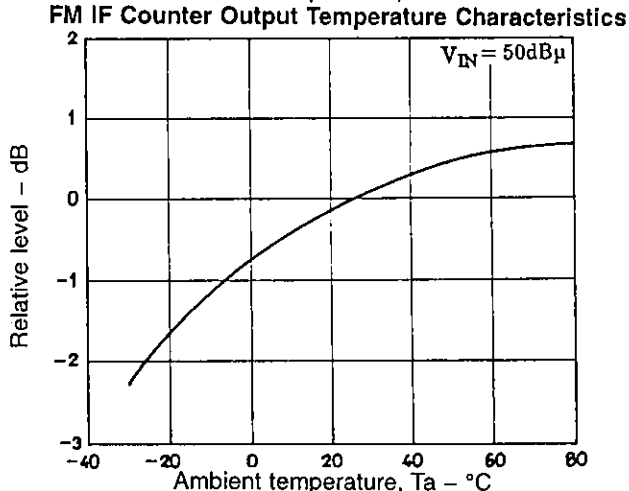
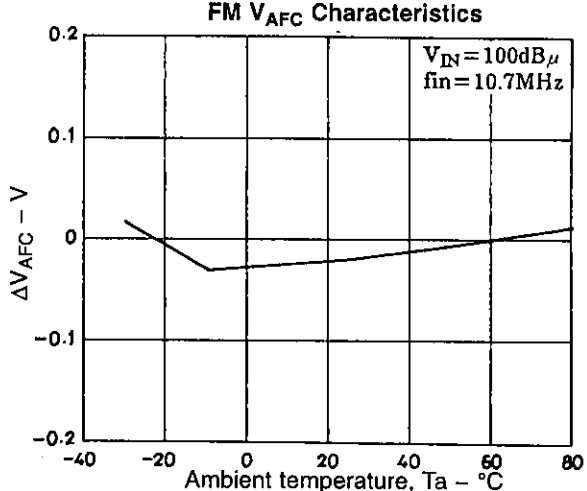
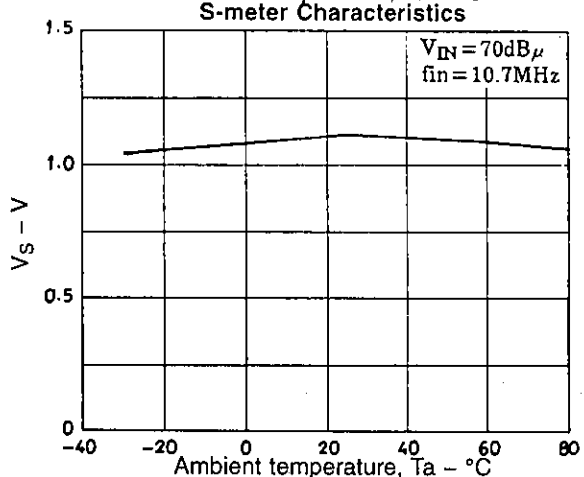
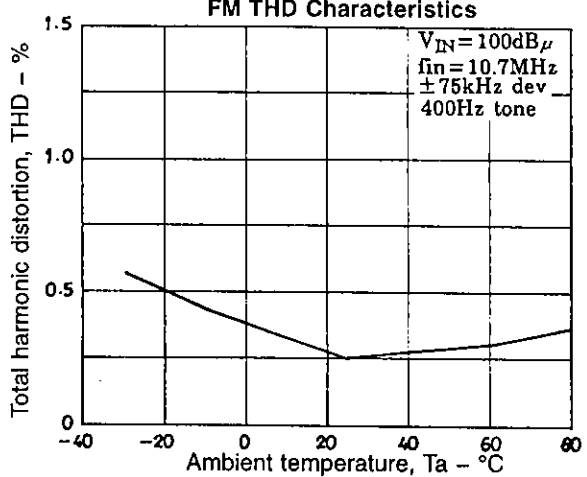
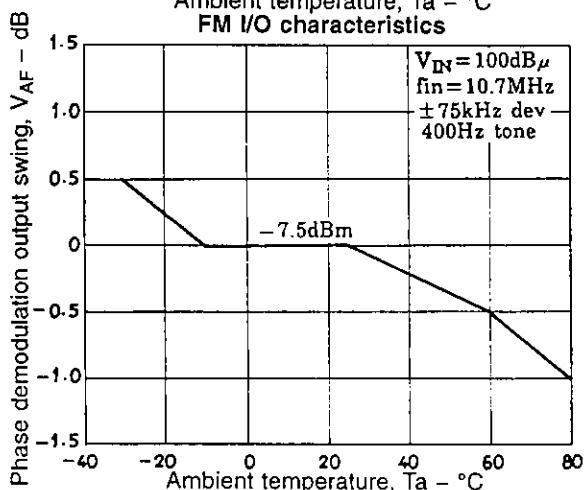
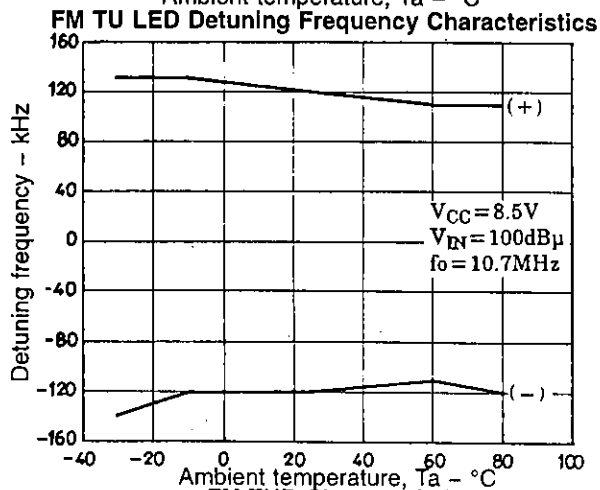
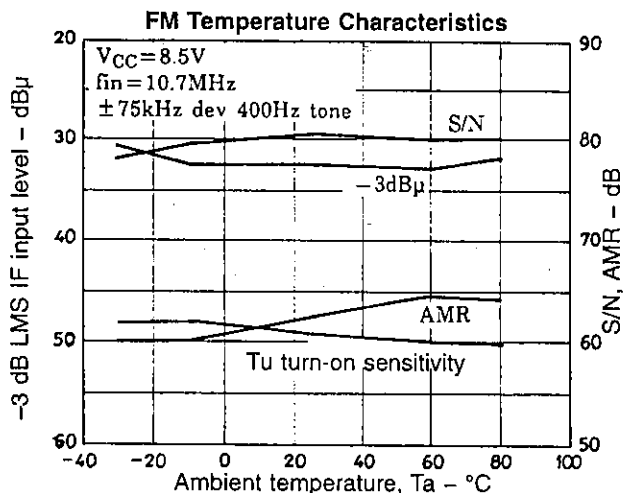
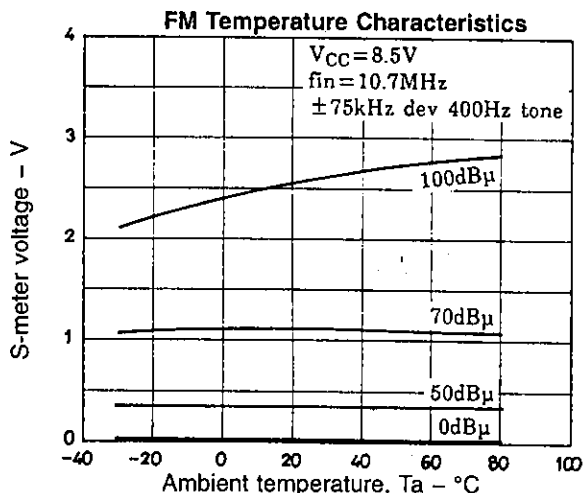

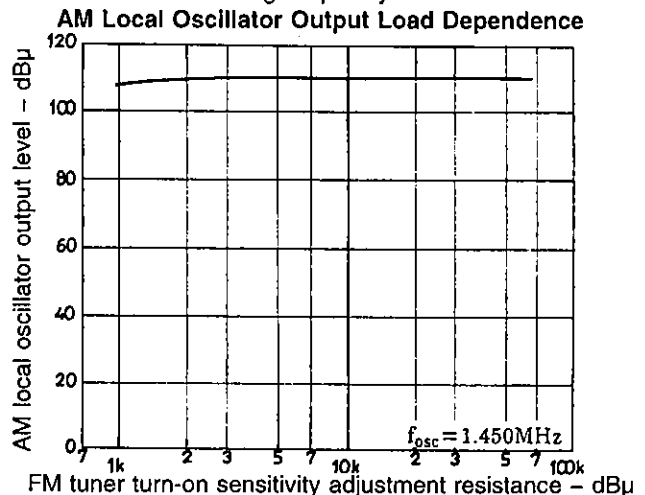
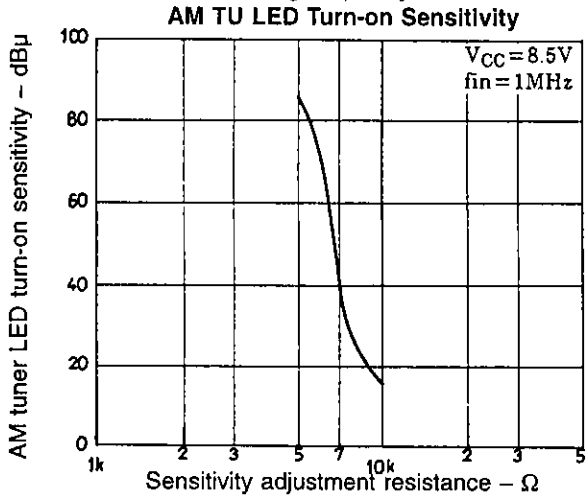
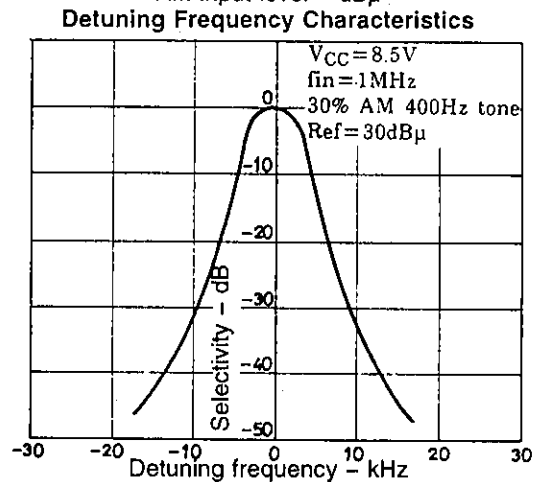
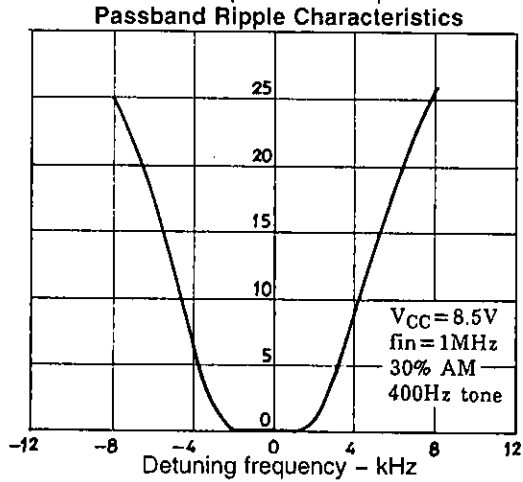
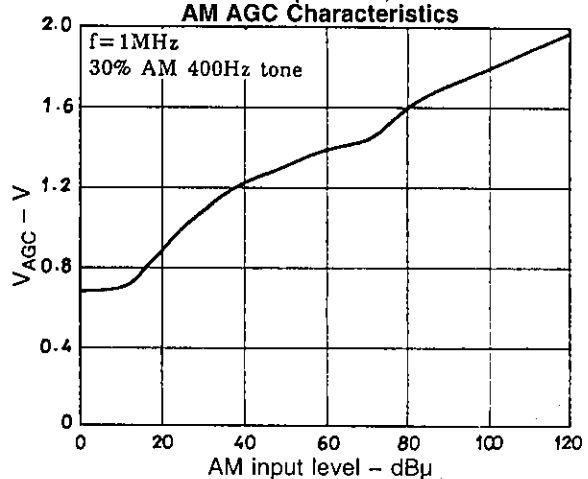
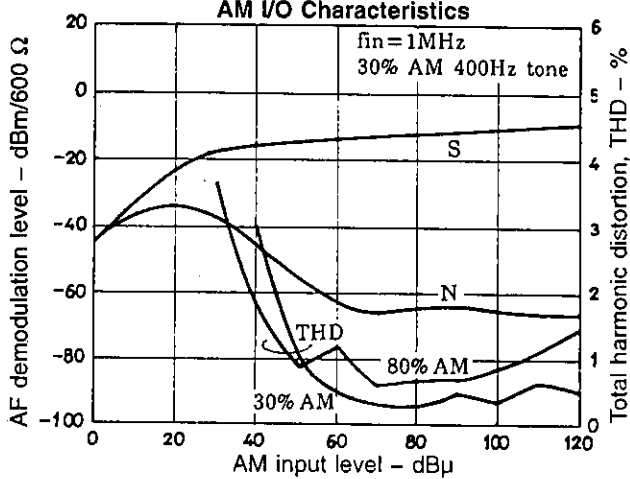
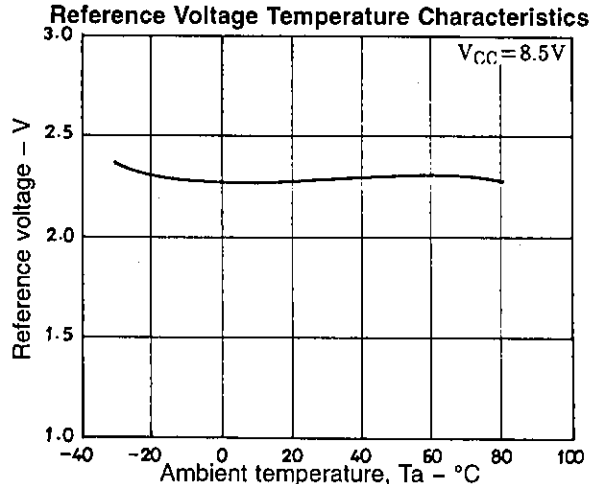
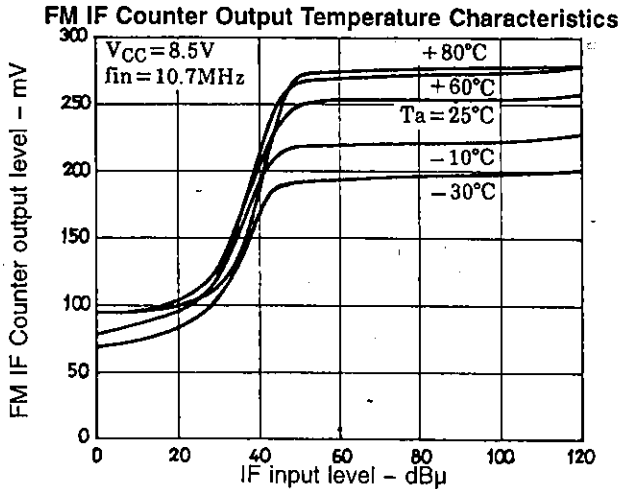

LA1851N

AM Local Oscillator Output Level Characteristics

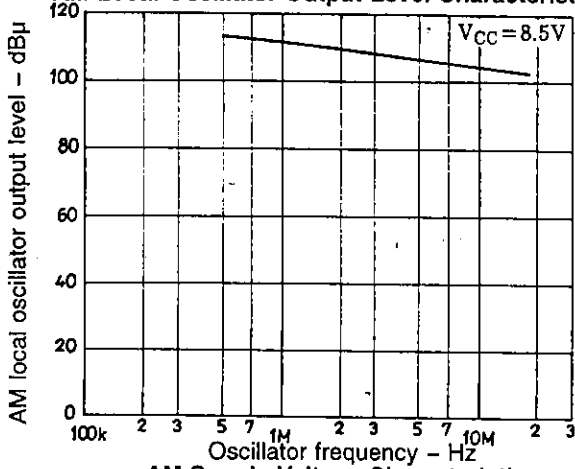

AM Supply Voltage Characteristics

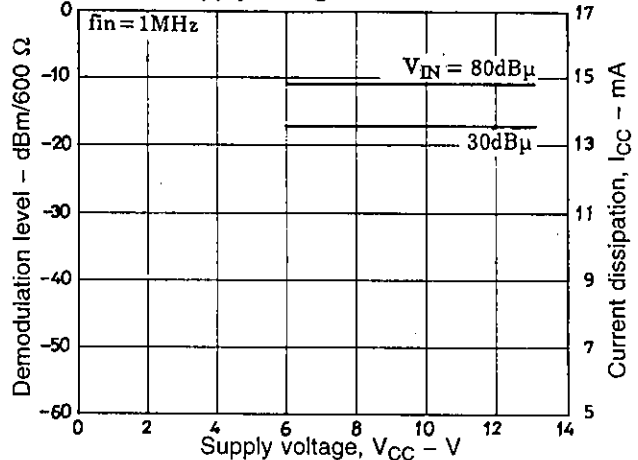

AM Supply Voltage Characteristics

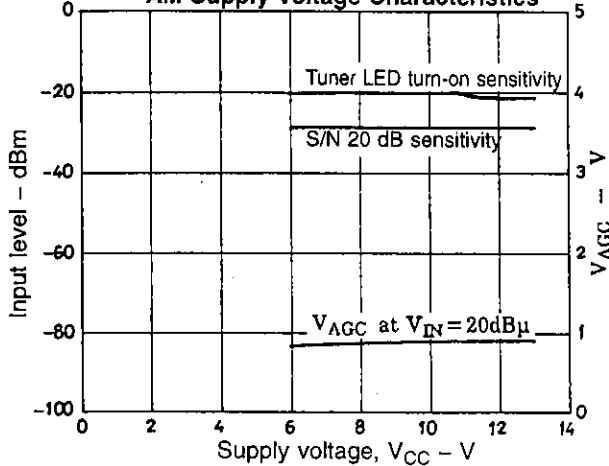

AM IF Counter Output Level

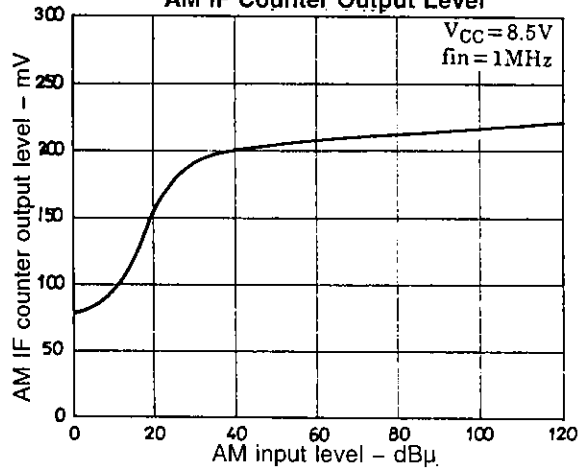

AM fidelity Characteristics

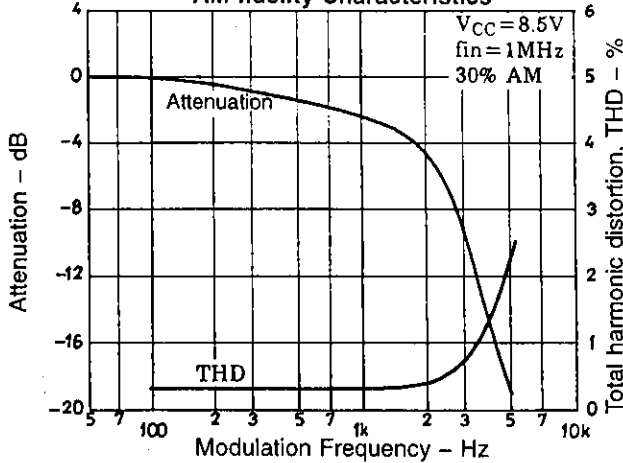

AM Temperature Characteristics

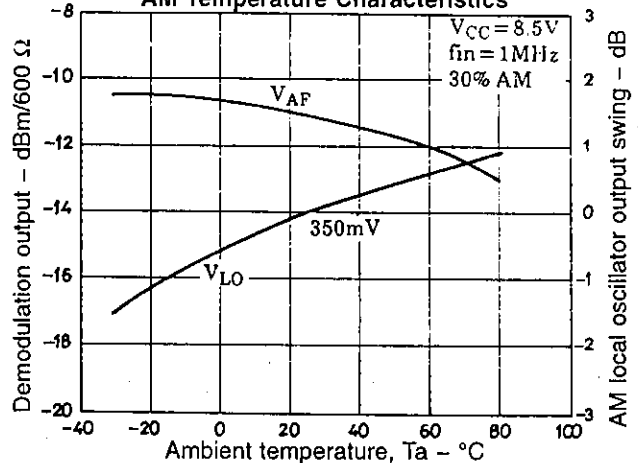

AM Temperature Characteristics

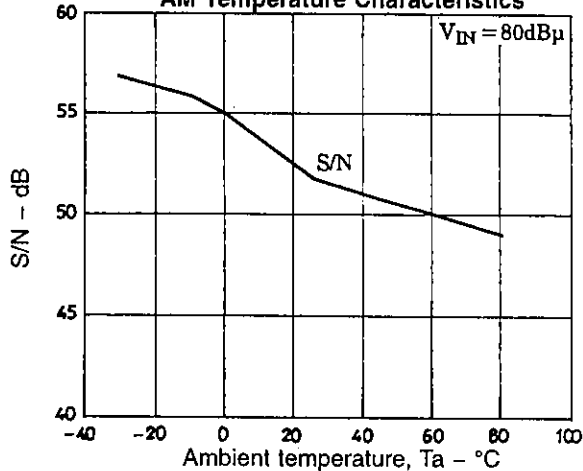

AM Temperature Characteristics

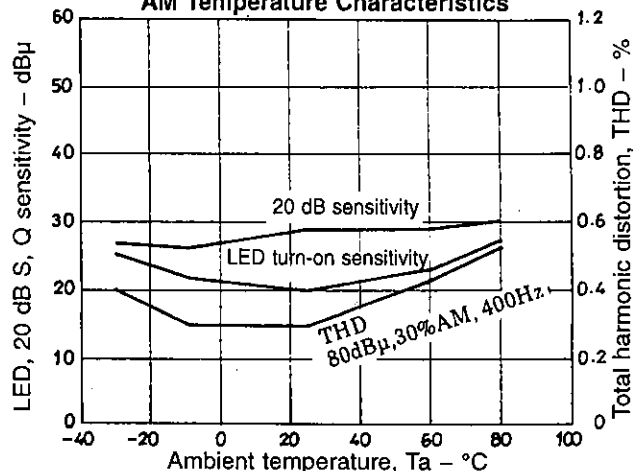

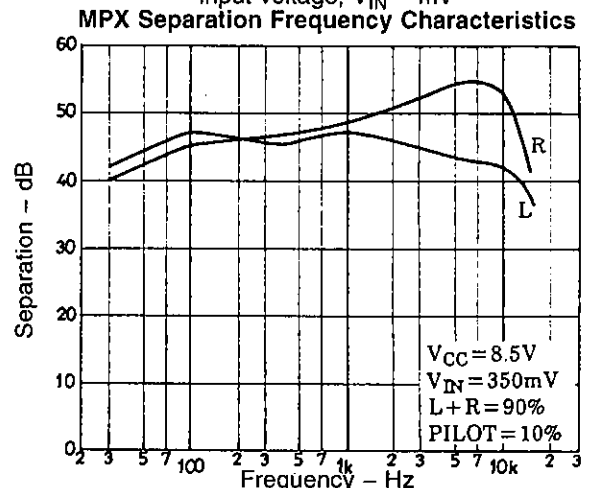
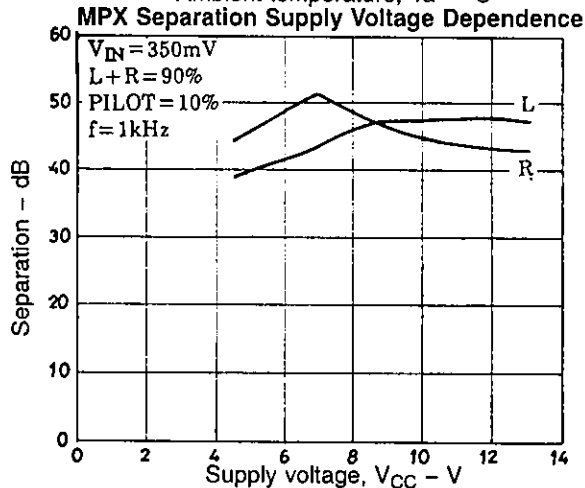
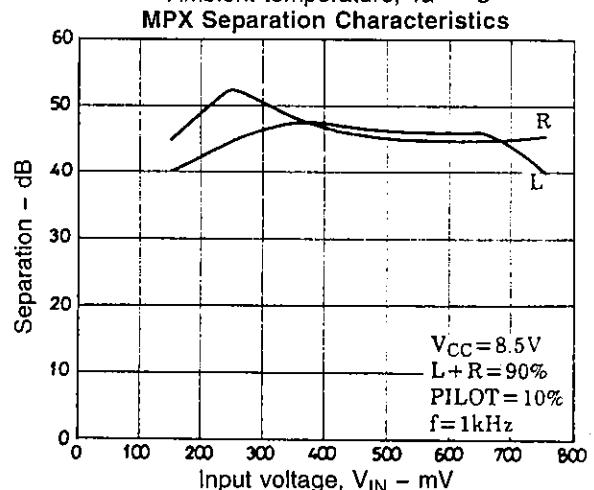
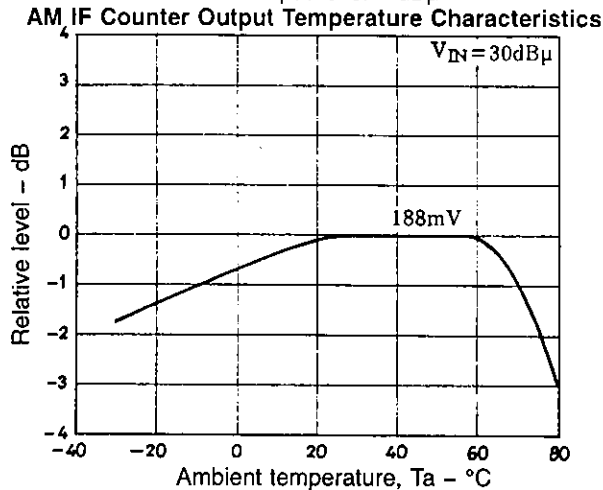
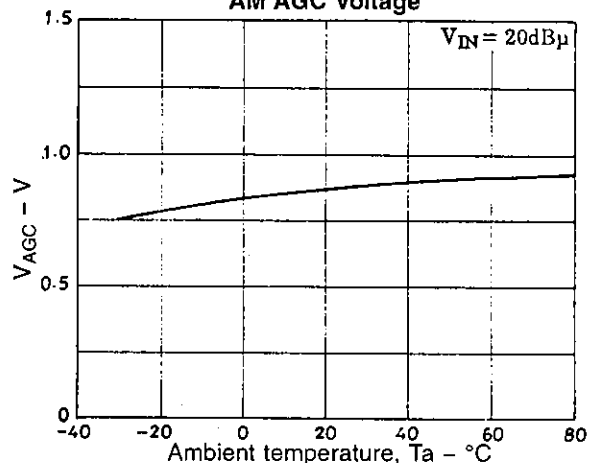
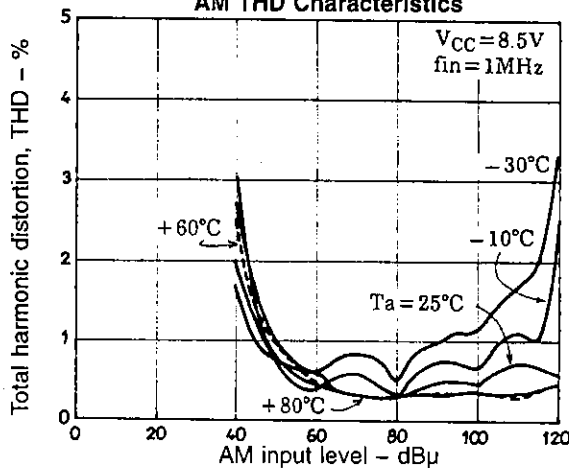
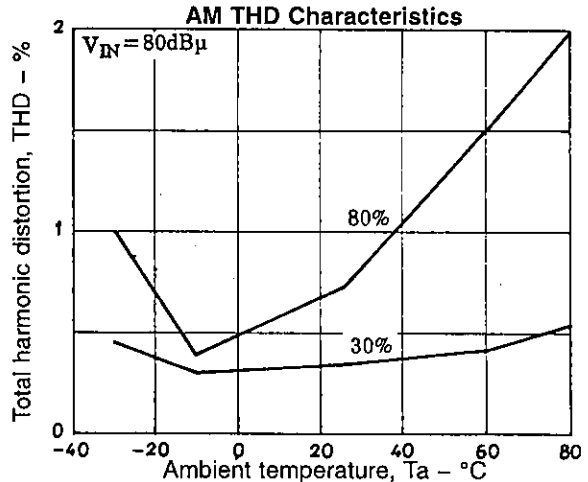
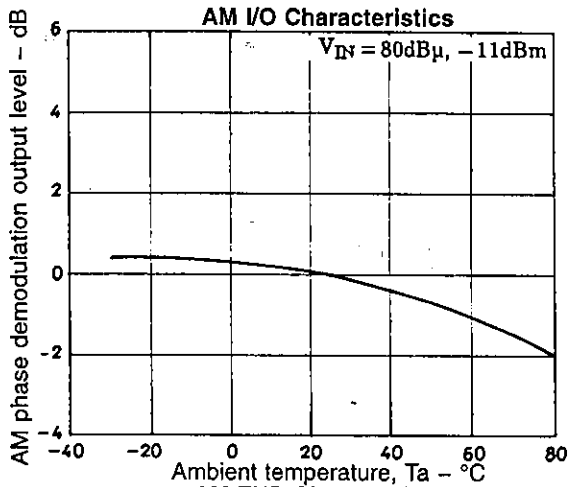

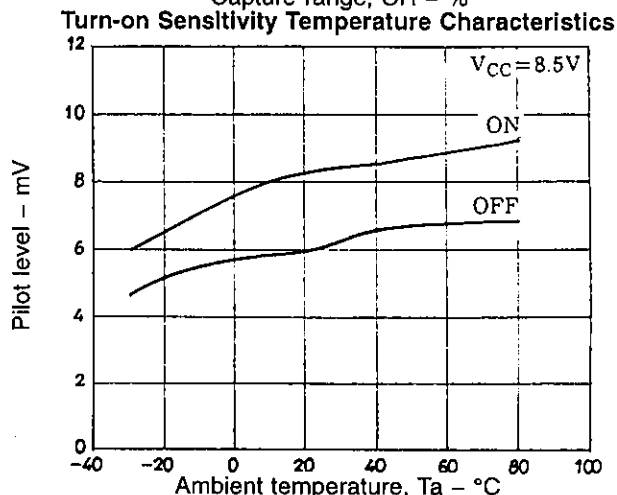
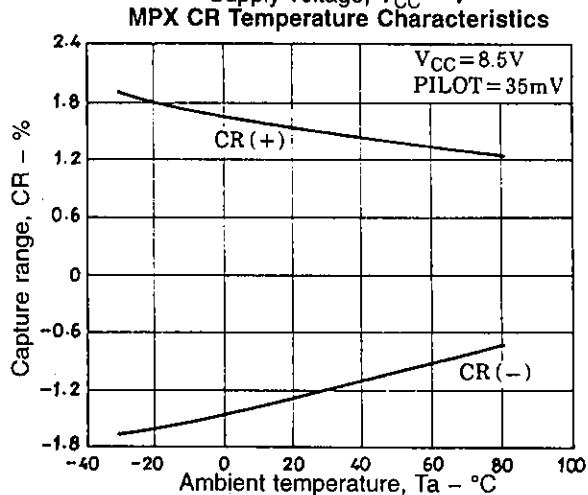
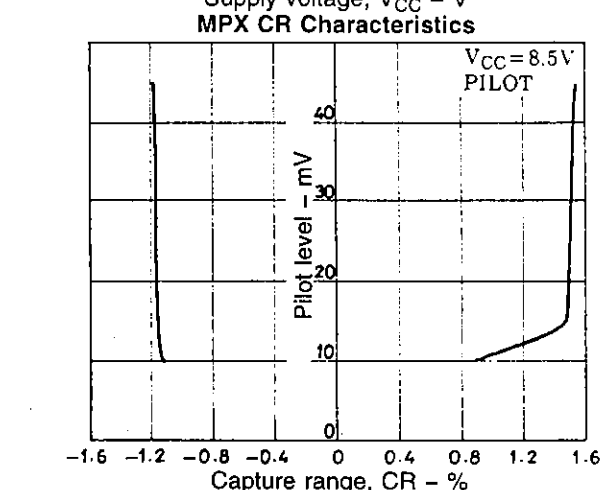
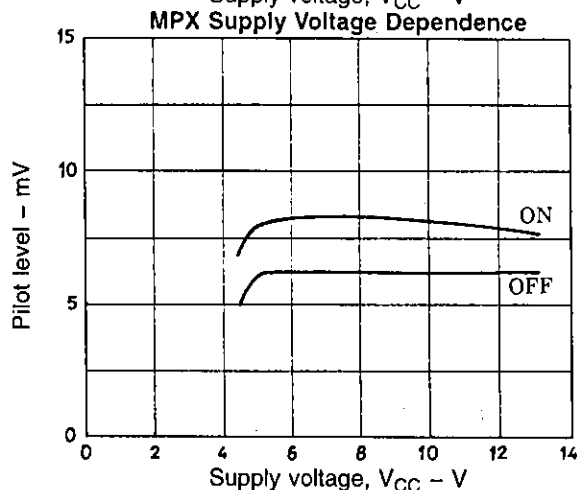
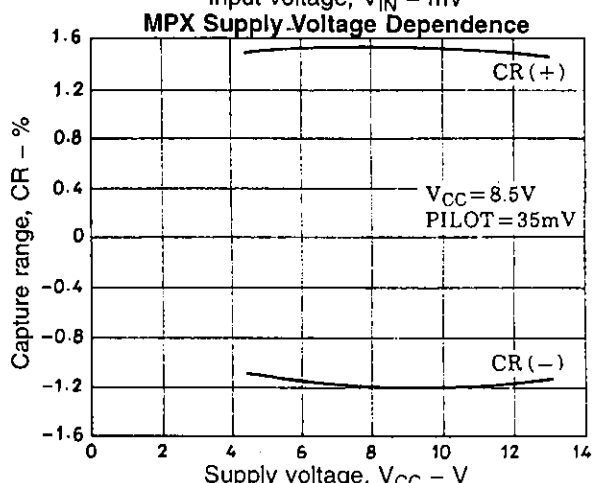
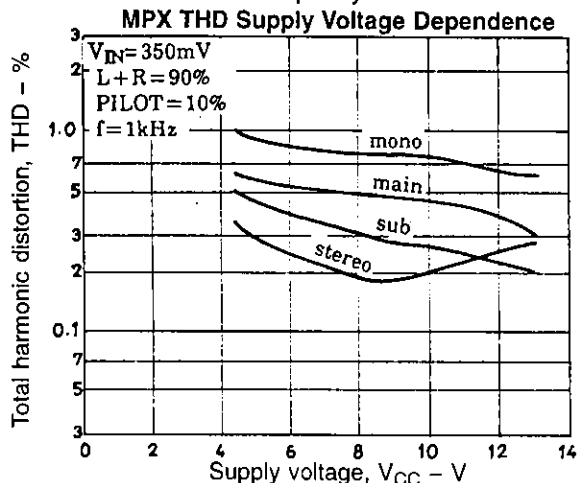
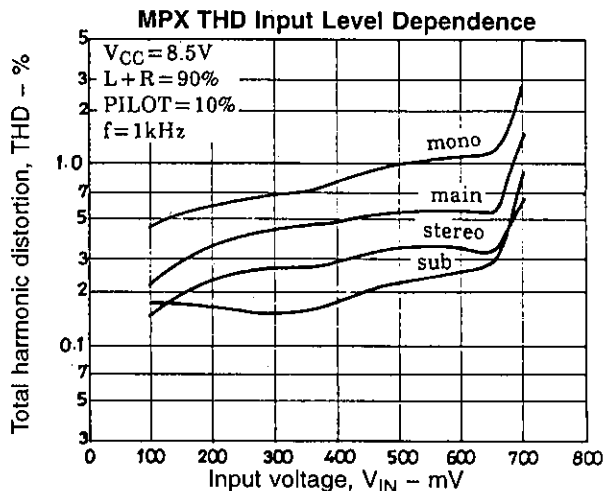
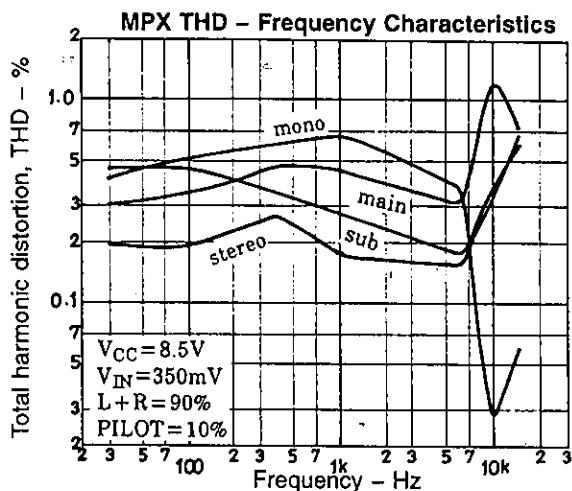

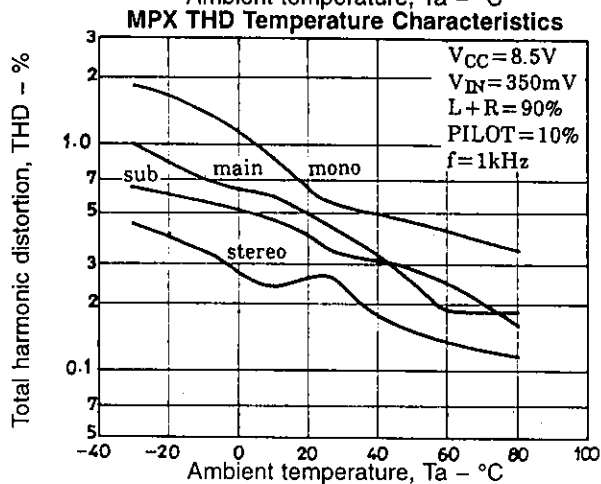
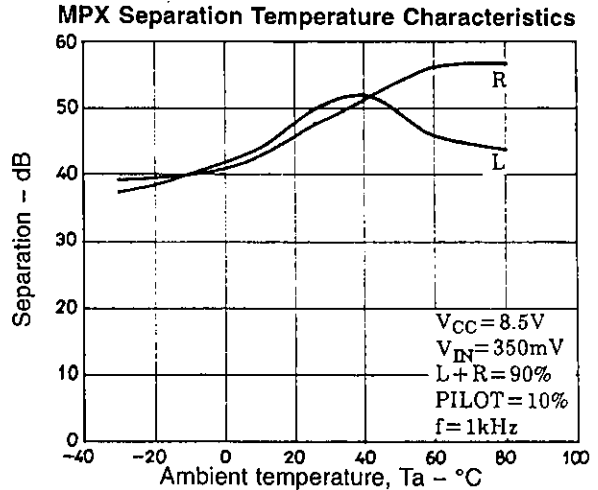
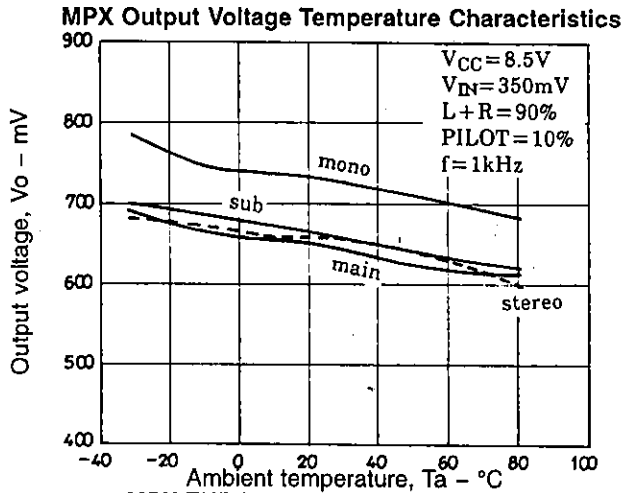

- No products described or contained herein are intended for use in surgical implants, life-support systems, aerospace equipment, nuclear power control systems, vehicles, disaster/crime-prevention equipment and the like, the failure of which may directly or indirectly cause injury, death or property loss.
- Anyone purchasing any products described or contained herein for an above-mentioned use shall:
 - ① Accept full responsibility and indemnify and defend SANYO ELECTRIC CO., LTD., its affiliates, subsidiaries and distributors and all their officers and employees, jointly and severally, against any and all claims and litigation and all damages, cost and expenses associated with such use;
 - ② Not impose any responsibility for any fault or negligence which may be cited in any such claim or litigation on SANYO ELECTRIC CO., LTD., its affiliates, subsidiaries and distributors or any of their officers and employees jointly or severally.
- Information (including circuit diagrams and circuit parameters) herein is for example only; it is not guaranteed for volume production. SANYO believes information herein is accurate and reliable, but no guarantees are made or implied regarding its use or any infringements of intellectual property rights or other rights of third parties.

This catalog provides information as of April 1996. Specifications and information herein are subject to change without notice.