

# LOW $V_{CE(sat)}$ 2SC4131

Silicon NPN Epitaxial Planar Transistor

Application : DC-DC Converter, Emergency Lighting Inverter and General Purpose

**Absolute maximum ratings** ( $T_a=25^\circ\text{C}$ )

Symbol	2SC4131	Unit
$V_{CBO}$	100	V
$V_{CEO}$	50	V
$V_{EBO}$	15	V
$I_C$	15(Pulse25)	A
$I_B$	4	A
$P_C$	60( $T_c=25^\circ\text{C}$ )	W
$T_J$	150	$^\circ\text{C}$
$T_{stg}$	-55 to +150	$^\circ\text{C}$

**Electrical Characteristics** ( $T_a=25^\circ\text{C}$ )

Symbol	Conditions	2SC4131	Unit
$I_{CBO}$	$V_{CB}=100\text{V}$	10max	$\mu\text{A}$
$I_{EBO}$	$V_{EB}=15\text{V}$	10max	$\mu\text{A}$
$V_{(BR)CEO}$	$I_C=25\text{mA}$	50min	V
$h_{FE}$	$V_{CE}=1\text{V}, I_C=5\text{A}$	60 to 360	
$V_{CE(sat)}$	$I_C=5\text{A}, I_B=80\text{mA}$	0.5max	V
$V_{BE(sat)}$	$I_C=5\text{A}, I_B=80\text{mA}$	1.2max	V
$f_r$	$V_{CE}=12\text{V}, I_E=-1\text{A}$	18typ	MHz
COB	$V_{CB}=10\text{V}, f=1\text{MHz}$	210typ	pF

**External Dimensions FM100(TO3PF)**

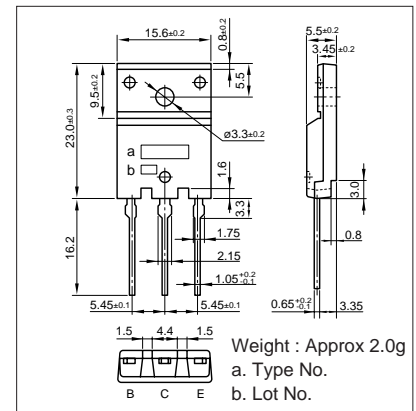

**Typical Switching Characteristics (Common Emitter)**

$V_{CC}$ (V)	$R_L$ ( $\Omega$ )	$I_C$ (A)	$V_{BB1}$ (V)	$V_{BB2}$ (V)	$I_{B1}$ (A)	$I_{B2}$ (A)	$t_{on}$ ( $\mu\text{s}$ )	$t_{stg}$ ( $\mu\text{s}$ )	$t_r$ ( $\mu\text{s}$ )
20	4	5	10	-5	0.08	-0.08	0.5typ	2.0typ	0.4typ

**$I_C-V_{CE}$  Characteristics (Typical)**

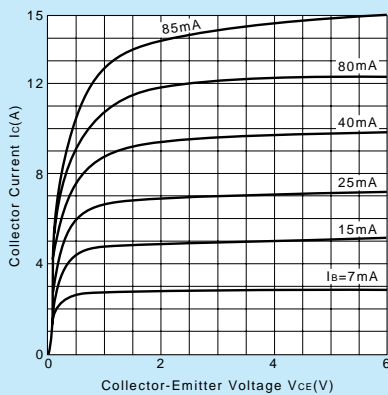

**$V_{CE(sat)}-I_B$  Characteristics (Typical)**

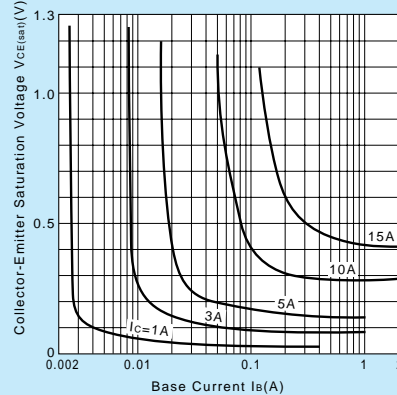

**$I_C-V_{BE}$  Temperature Characteristics (Typical)**

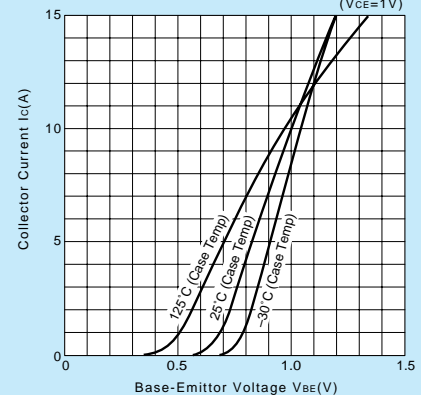

**$h_{FE}-I_C$  Characteristics (Typical)**

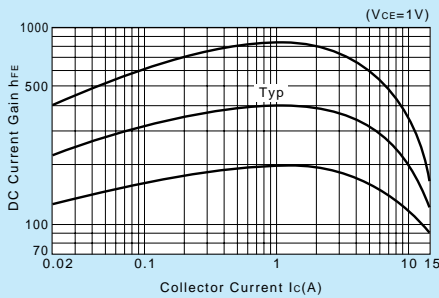

**$h_{FE}-I_C$  Temperature Characteristics (Typical)**

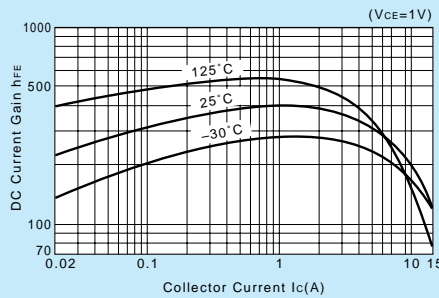

**$\theta_{j-a}-t$  Characteristics**

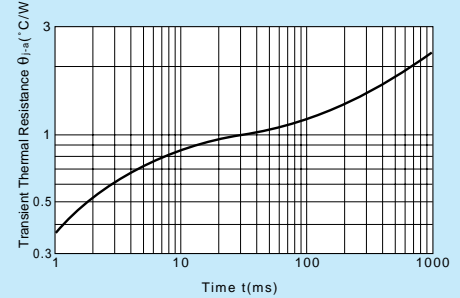

**$t_{on} \cdot t_{stg} \cdot t_r - I_C$  Characteristics (Typical)**

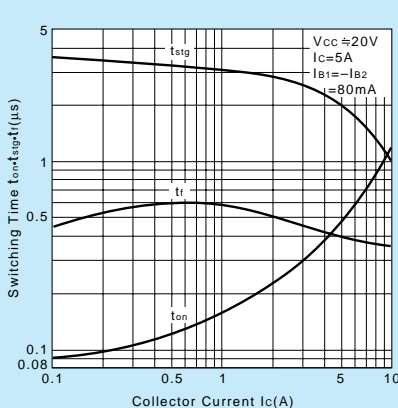

**Safe Operating Area (Single Pulse)**

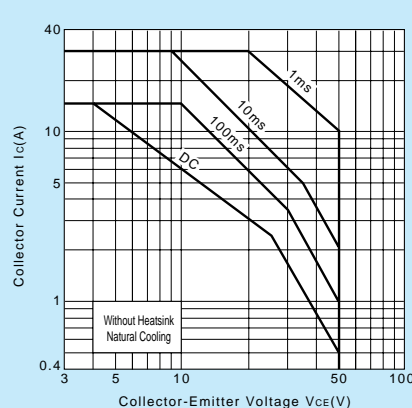

**$P_C-T_a$  Derating**

