

SPY0029A

Linear Regulator

Preliminary

OCT. 15, 2002

Version 0.2

Table of Contents

	<u>PAGE</u>
1. GENERAL DESCRIPTION	3
2. APPLICATION	3
3. FEATURES	3
4. BLOCK DIAGRAM	3
5. SIGNAL DESCRIPTIONS	4
5.1. 4 PIN (SOT-92).....	4
5.2. 3 PIN (SOT-89).....	4
5.3. PIN CONFIGURATION.....	4
6. ELECTRICAL SPECIFICATIONS	5
6.1. ABSOLUTE MAXIMUM RATINGS	5
6.2. DC CHARACTERISTIC	5
6.3. BONDING OPTION (SEVERAL OUTPUT VOLTAGE)	5
6.4. TYPICAL OPERATING CHARACTERISTICS.....	6
6.4.1. Output voltage vs. output current (Vout = 3.3V).....	6
6.4.2. Output voltage vs. output current (Vout = 3.0V).....	6
6.4.3. Output voltage vs. output current (Vout = 2.7V).....	6
6.4.4. Output voltage vs. output current (Vout = 2.55V).....	6
6.4.5. Output voltage vs. input voltage (Vout = 3.3V).....	7
6.4.6. Output voltage vs. input voltage (Vout = 3.0V).....	7
6.4.7. Output voltage vs. input voltage (Vout = 2.7V).....	7
6.4.8. Output voltage vs. input voltage (Vout = 2.55V).....	7
6.4.9. Output voltage vs. temperature (Vout = 3.3V).....	8
6.4.10. Output voltage vs. temperature (Vout = 3.0V)	8
6.4.11. Output voltage vs. temperature (Vout = 2.7V)	8
6.4.12. Output voltage vs. Temperature (Vout = 2.55V).....	8
6.4.13. Load –transient response test module	9
6.4.14. Load –transient response; Vout = 3.3V	9
6.4.15. Load –transient response; Vout = 3.0V	9
6.4.16. Load –transient response; Vout = 2.7V	9
6.4.17. Load –transient response; Vout = 2.55V	9
6. APPLICATION CIRCUIT	10
6.1. 4 PIN (WITH LOW VOLTAGE DETECTED FUNCTION).....	10
6.2. 3 PIN (NO LOW VOLTAGE DETECTED FUNCTION)	10
7. PACKAGE/PAD LOCATIONS	11
7.1. PAD ASSIGNMENT	11
7.2. ORDERING INFORMATION	11
7.3. PAD LOCATIONS	11
7.4. PACKAGE INFORMATION	12
7.4.1. 4 PIN SOT92 package size	12
7.4.2. 3 PIN SOT89 package size	13
9. DISCLAIMER	14
10. REVISION HISTORY	15

LINEAR REGULATOR

1. GENERAL DESCRIPTION

The SPY0029A is a voltage regulator IC with ultra-low quiescent current and low voltage detection by CMOS process. It operates to +7.0V input range and delivers up to 50mA.

2. APPLICATION

- Battery-powered equipment
- Hand-held communication equipment
- Audio/Video system
- Toys

3. FEATURES

- Low Quiescent Current (Typ. $3\mu\text{A}$ @ $V_{\text{OUT}} = 3.3\text{V}$, $V_{\text{IN}} = 5.0\text{V}$)
- High Current Driving Capability
(Typ. 50mA @ $V_{\text{OUT}} = 3.3\text{V}$, $V_{\text{IN}} = 5.0\text{V}$)
- Small Dropout Voltage (Typ. 40mV @ $V_{\text{OUT}} = 3.3\text{V}$, $I_{\text{OUT}} = 1.0\text{mA}$)
- Low Temperature-Drift Coefficient of Output Voltage
(Typ. $\pm 50\text{ppm}/^\circ\text{C}$)
- Excellent Line Regulation (Typ. $0.15\%/V$)
- Bonding Options Output Voltage (2.55V, 2.7V, 3.0V, 3.3V)
- High Accuracy Output Voltage ($\pm 5\%$)
- Low Voltage Detection.
(A. Overload detection, B. Low battery detection)
- 3 pin and 4 pin Types of Package or Dice Form

4. BLOCK DIAGRAM

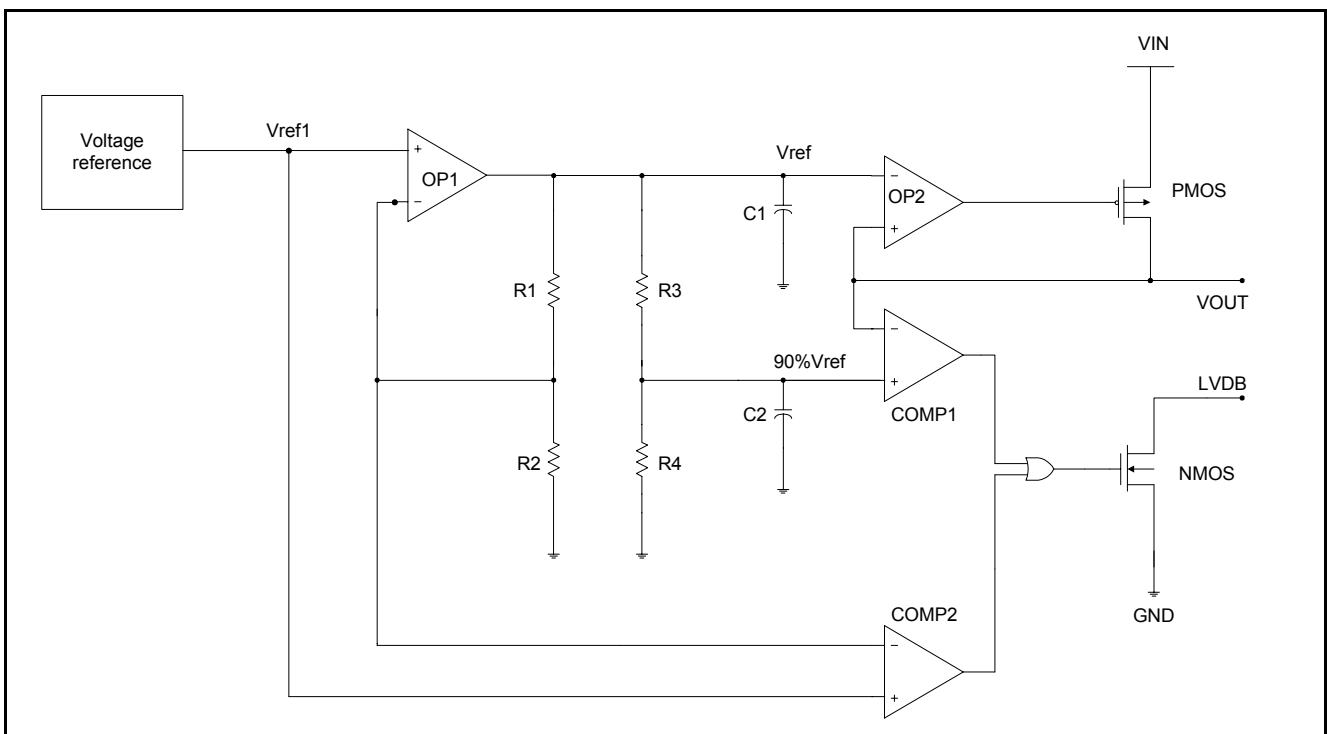

5. SIGNAL DESCRIPTIONS

5.1. 4 PIN (SOT-92)

Mnemonic	PIN No.	Type	Description
GND	1	G	Chip Ground
VIN	2	I	Input Voltage.
VOUT	3	O	Output Regulated Voltage.
LVDB	4	O	Low voltage detection, Low activity

5.2. 3 PIN (SOT-89)

Mnemonic	PIN No.	Type	Description
GND	1	G	Chip Ground
VIN	2	I	Input Voltage.
VOUT	3	O	Output Regulated Voltage.

5.3. PIN Configuration

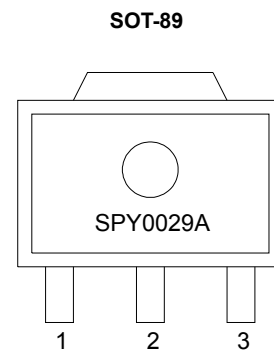
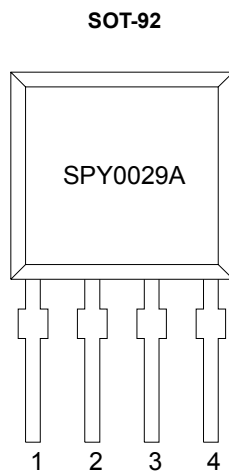

6. ELECTRICAL SPECIFICATIONS

6.1. Absolute Maximum Ratings

Characteristic	Symbol	Rating	Unit
Input Voltage	V_{IN}	+7.0V	V
Output Voltage	V_{OUT}	-0.3 ~ ($V_{IN} + 0.3$)	V
Operating Temperature	T_{OPT}	0 - 70	°C
Storage Temperature	T_{STG}	-40 - 125	°C

Note: Stresses beyond those given in the Absolute Maximum Rating table may cause operational errors or damage to the device. For normal operational conditions see Electrical Characteristic

6.2. DC Characteristic

($V_{OUT}(\text{target}) = 3.3V / 3.0V / 2.7V / 2.55V$, Typical values are at $T_{OPT} = 25^\circ\text{C}$)

Item	Test Conditions	Symbol	Min.	Typ.	Max.	Unit
Output Voltage Accuracy	$V_{IN} = 5.0V$, $10\mu A \leq I_{OUT} \leq 10mA$, $V_{OUT} = 3.3V$	$\frac{V_{out} - V_{out}(\text{target})}{V_{out}(\text{target})}$	-5.0	-	5.0	%
Output Current	$V_{IN} = 5.0V$, $V_{OUT} = 3.3V$	I_{OUT}	35	50	-	mA
Load Regulation	$V_{IN} = 5.0V$, $1mA \leq I_{OUT} \leq 50mA$, $V_{OUT} = 3.3V$	ΔV_{OUT}	-	40	60	mV
Dropout Voltage	$I_{OUT} = 1mA$, $V_{in} = V_{OUT}(\text{normal})$, $V_{DIF} = V_{IN} - V_{OUT}$, $V_{OUT} = 3.3V$	V_{DIF}	-	40	60	mV
Quiescent Current	$V_{IN} = 5.0V$, $V_{OUT} = 3.3V$	I_{SS}	-	3.0	6.0	μA
Line Regulation	$I_{OUT} = 1mA$, $V_{OUT} + 0.5V \leq V_{IN} \leq 7.0V$, $V_{OUT} = 3.3V$	$\frac{\Delta V_{out}}{\Delta V_{in} \times V_{out}}$	-	0.15	-	%/V
Input Voltage	$V_{OUT} = 3.3V$	V_{IN}	-	-	7.0	V
Temperature Coefficient	$I_{OUT} = 10mA$, $0^\circ\text{C} \leq T_{OPT} \leq 70^\circ\text{C}$, $V_{OUT} = 3.3V$	$\frac{\Delta V_{out}}{\Delta T}$	-	± 50	-	ppm/°C
Low Voltage Detection Threshold	(A) $1 - \frac{V_{out}}{V_{out}(\text{Normal})}$, $V_{OUT} = 3.3V$	V_{DET}	5.0	10	15	%
	(B) $\Delta V = V_{OUT}(\text{Normal}) - V_{IN}$, $V_{OUT} = 3.3V$	ΔV	-	± 60	-	mV
LVDB Output Voltage Low (Open Nmos Drain)	$I_{SINK} = 1mA$, $V_{OUT} = 3.3V$	VO_L	-	-	0.4	V

Note: $V_{OUT}(\text{normal}) @ V_{IN} = 5.0V$, $I_{OUT} = 1mA$, $V_{out} = 3.3V$, $T_{OPT} = 25^\circ\text{C}$

6.3. Bonding Option (several output voltage)

Option	Output voltage	Power source bonding PAD no.
1	3.3V	2 (note1)
2	3.0V	2 & 6 (note 2)
3	2.7V	2 & 5 & 6 (note 3)
4	2.55V	2 & 5 (note 4)

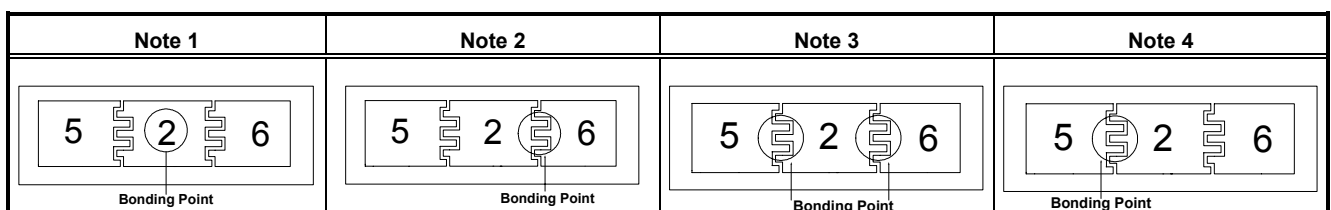

6.4. Typical Operating Characteristics

6.4.1. Output voltage vs. output current (Vout = 3.3V)

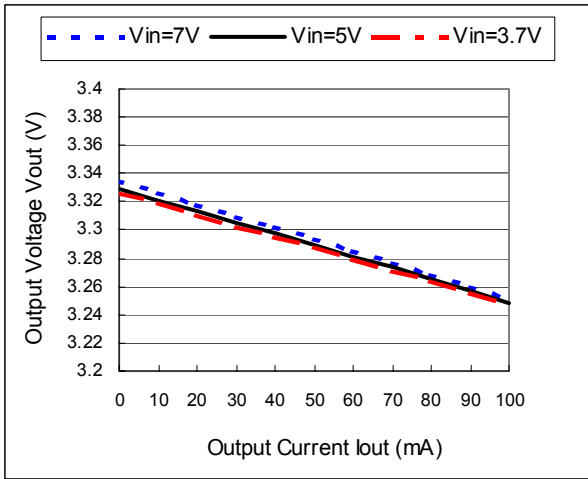

6.4.3. Output voltage vs. output current (Vout = 2.7V)

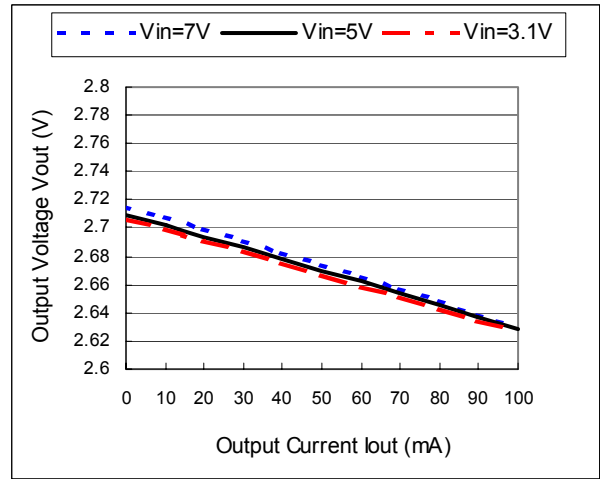

6.4.2. Output voltage vs. output current (Vout = 3.0V)

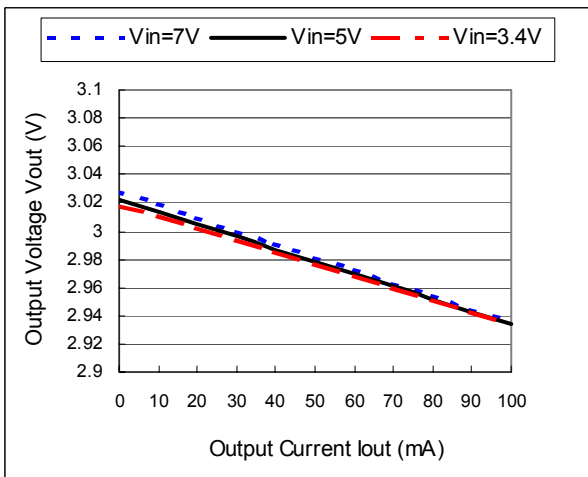

6.4.4. Output voltage vs. output current (Vout = 2.55V)

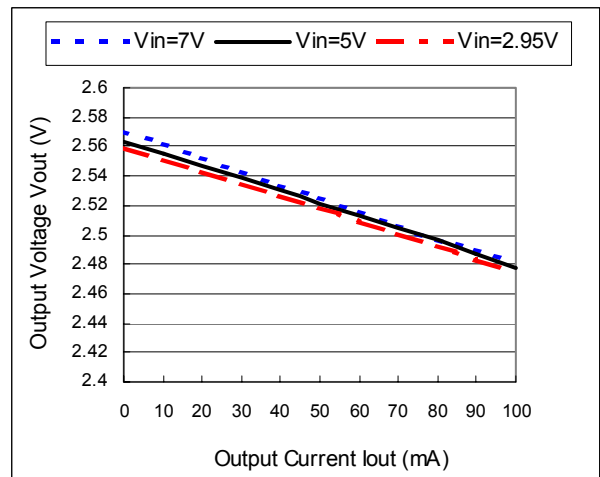

6.4.5. Output voltage vs. input voltage (Vout = 3.3V)

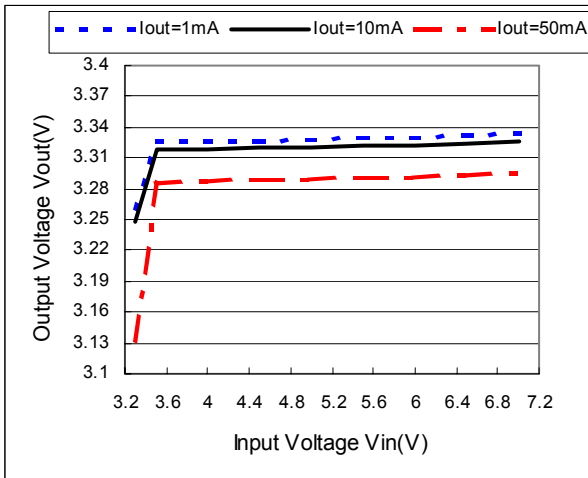

6.4.7. Output voltage vs. input voltage (Vout = 2.7V)

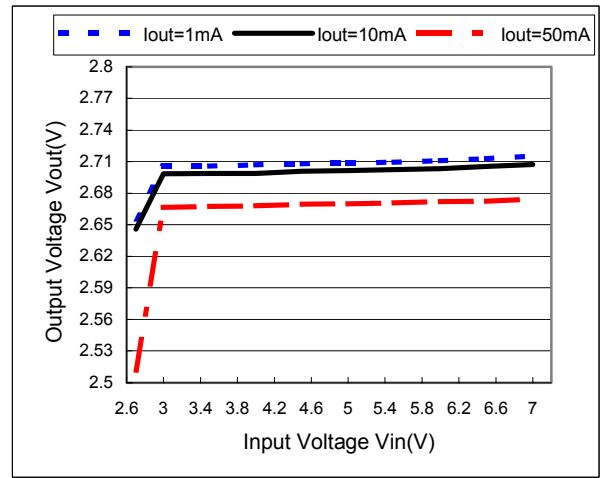

6.4.6. Output voltage vs. input voltage (Vout = 3.0V)

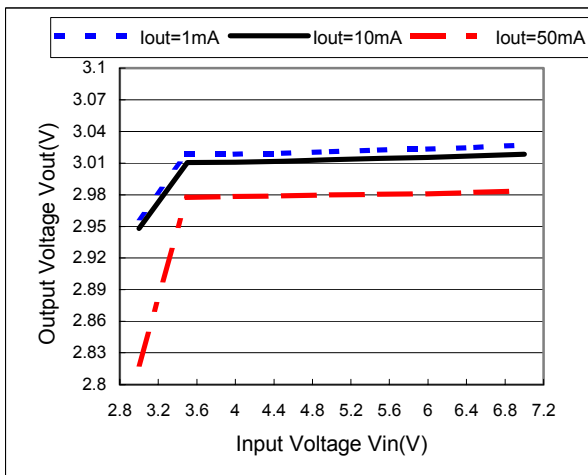

6.4.8. Output voltage vs. input voltage (Vout = 2.55V)

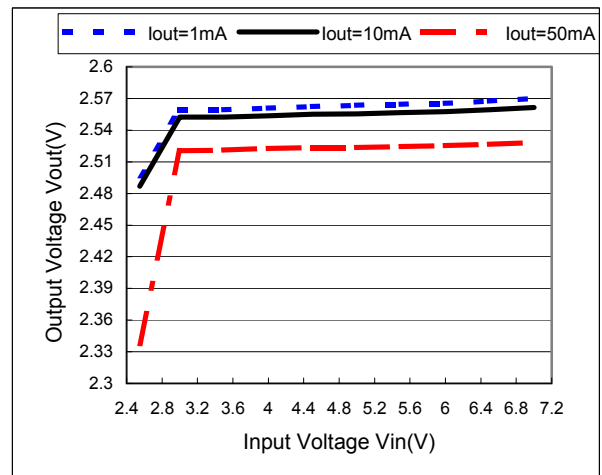

6.4.9. Output voltage vs. temperature (Vout = 3.3V)

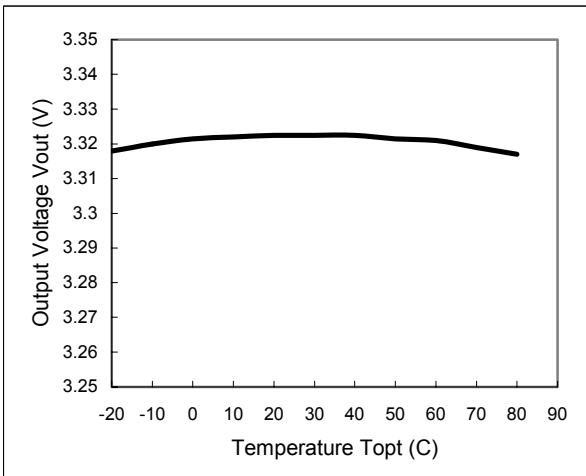

6.4.11. Output voltage vs. temperature (Vout = 2.7V)

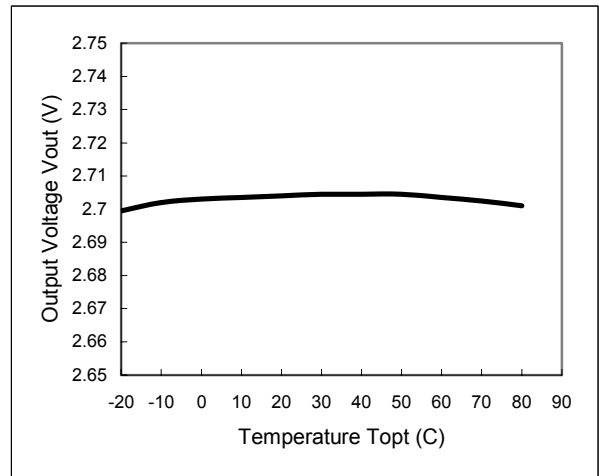

6.4.10. Output voltage vs. temperature (Vout = 3.0V)

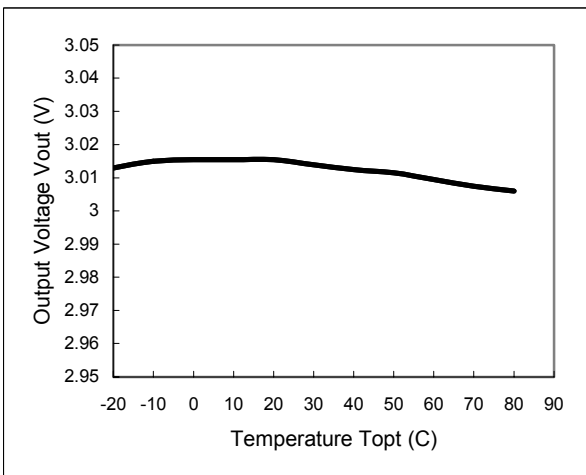

6.4.12. Output voltage vs. Temperature (Vout = 2.55V)

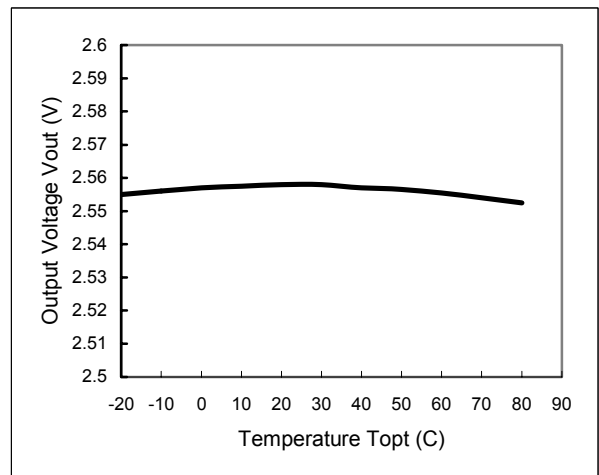

6.4.13. Load –transient response test module

($V_{IN} = 5V$, $I_{OUT} = 0$ to $50mA$, $C_{LOAD} = 10\mu F$)

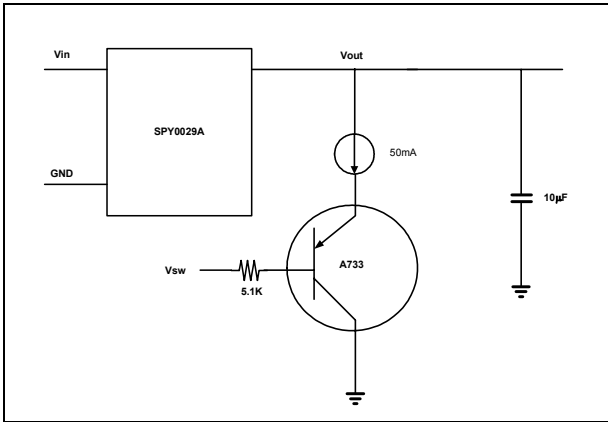

6.4.16. Load –transient response; $V_{out} = 2.7V$

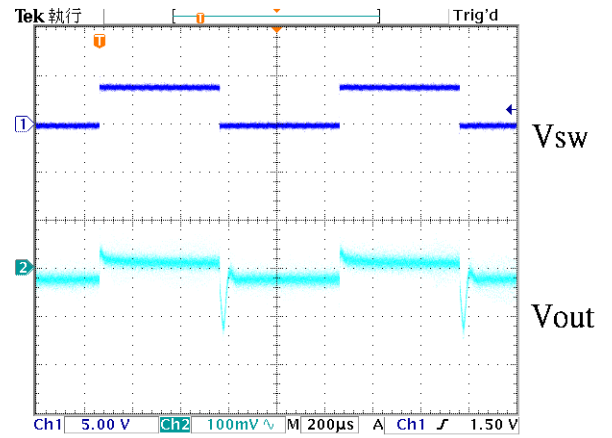

6.4.14. Load –transient response; $V_{out} = 3.3V$

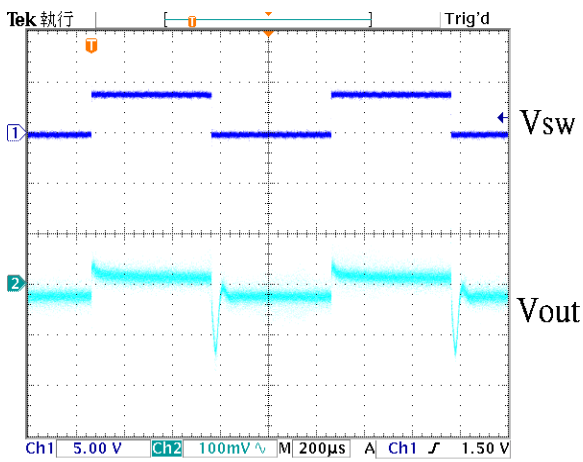

6.4.17. Load –transient response; $V_{out} = 2.55V$

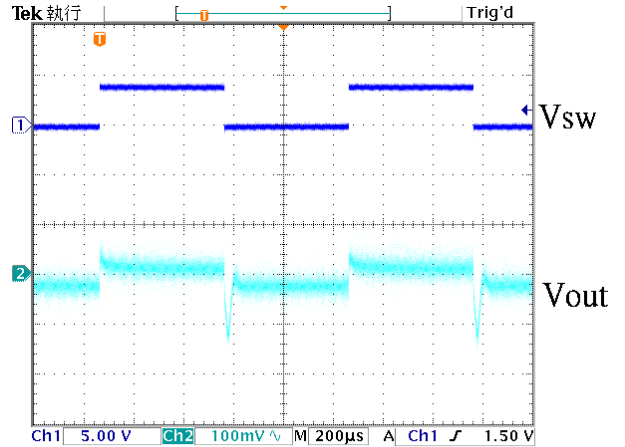

6.4.15. Load –transient response; $V_{out} = 3.0V$

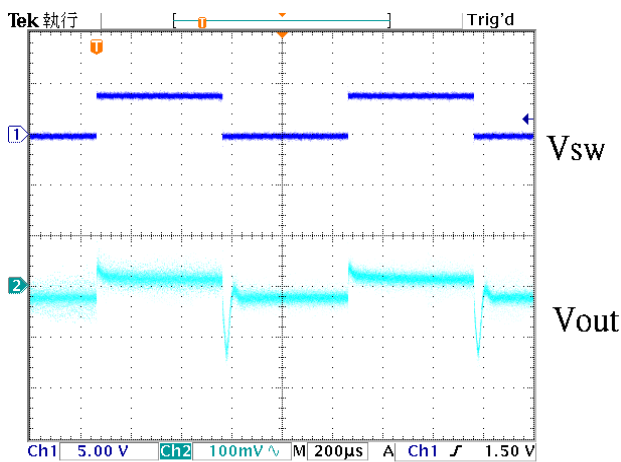

6. APPLICATION CIRCUIT

6.1. 4 PIN (with Low Voltage Detected Function)

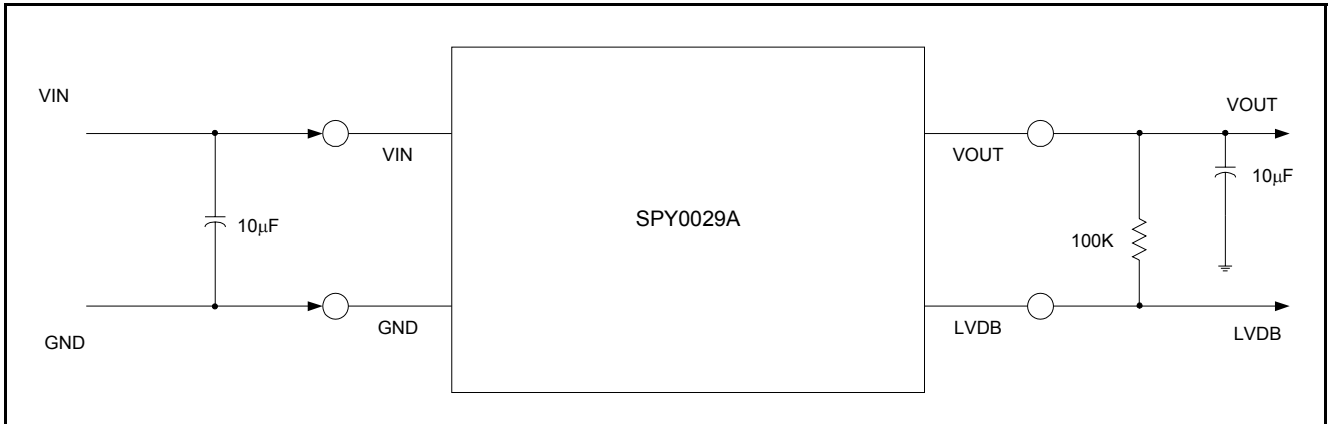

6.2. 3 PIN (no Low Voltage Detected Function)

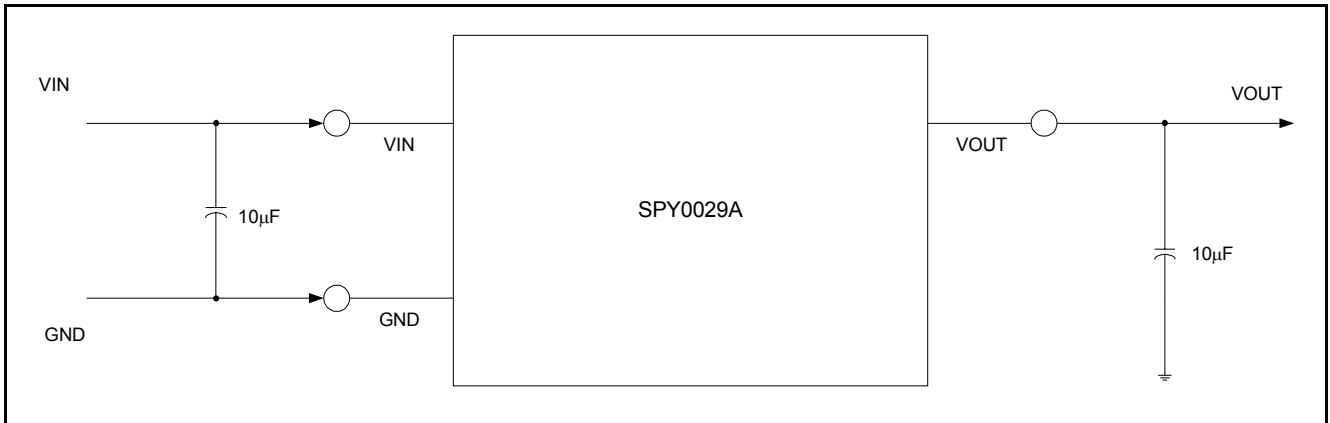

7. PACKAGE/PAD LOCATIONS

7.1. PAD Assignment

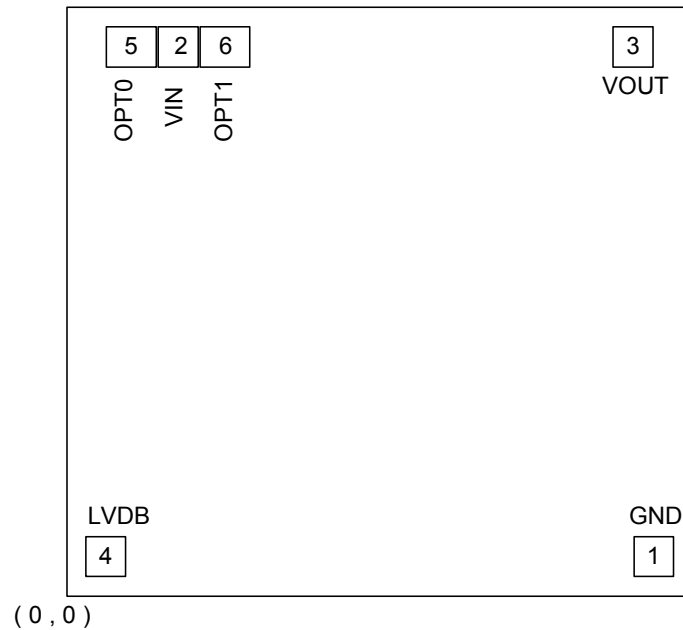

Chip Size: 1050 μ m \times 1180 μ m

This IC substrate should be connected to VSS

Note1: Chip size included scribe line.

Note2: To ensure that the IC functions properly, please bond all of VDD and VSS pins.

Note3: The 0.1 μ F capacitor between VDD and VSS should be placed to IC as close as possible.

7.2. Ordering Information

Product Number	Package Type
SPY0029A-C	Chip form
SPY0029A-PE01	Package form - SOT89
SPY0029A-PE02	Package form - SOT92

7.3. PAD Locations

PAD No.	PAD Name	X	Y
1	GND	821	110
2	VIN	363	972
3	VOUT	770	972
4	LVDB	153	105
5	OPT0	153	972
6	OPT1	573	972

7.4. Package Information

7.4.1. 4 PIN SOT92 package size

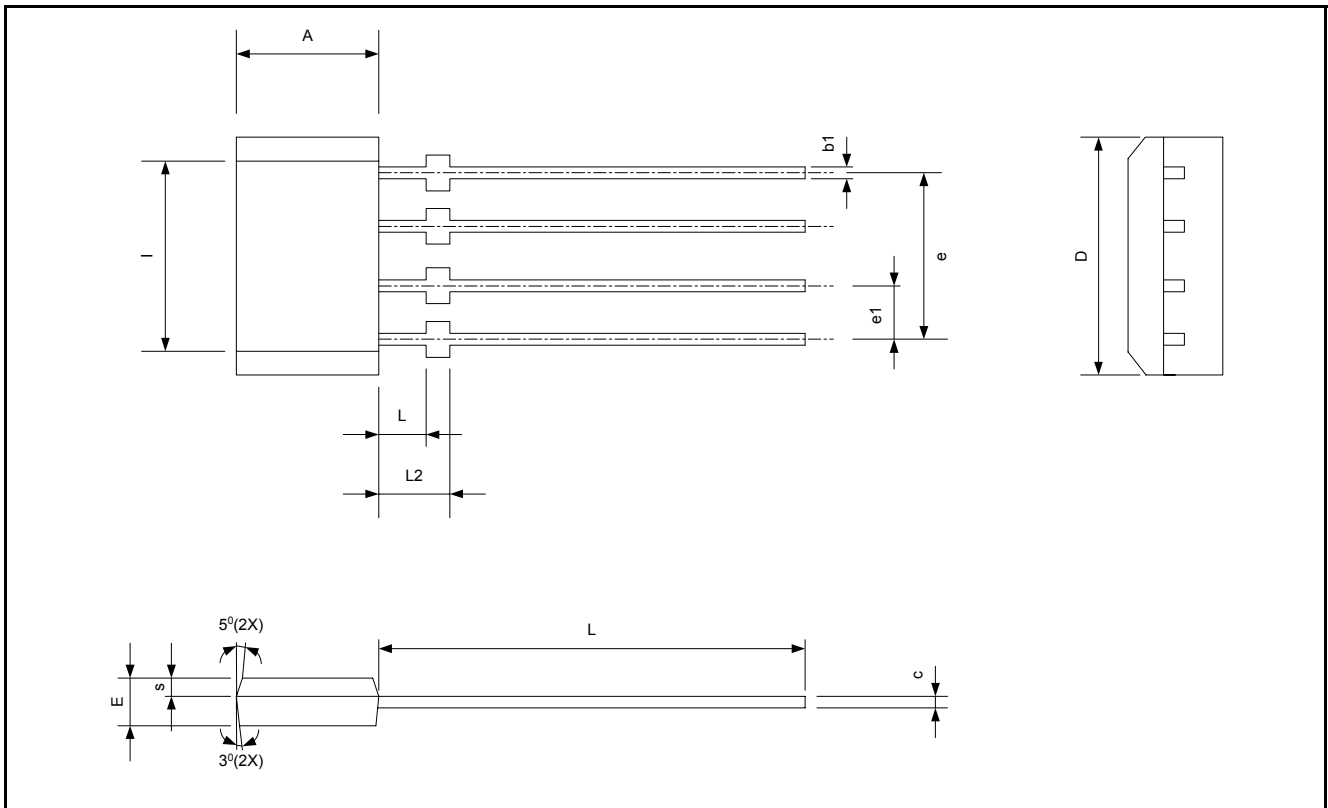

Symbol	Min.	Nom.	Max.	Unit
A	3.60	3.65	3.70	Millimeter
b1	0.35	0.38	0.41	Millimeter
c	0.351	0.381	0.411	Millimeter
D	5.17	5.22	5.27	Millimeter
e	3.78	3.81	3.84	Millimeter
e1	1.24	1.27	1.30	Millimeter
E	1.50	1.55	1.60	Millimeter
l	4.04	4.20	4.34	Millimeter
L	13.8	14.3	14.8	Millimeter
L1	0.814	0.914	1.014	Millimeter
L2	1.342	1.442	1.542	Millimeter
s	0.70	0.73	0.76	Millimeter

7.4.2. 3 PIN SOT89 package size

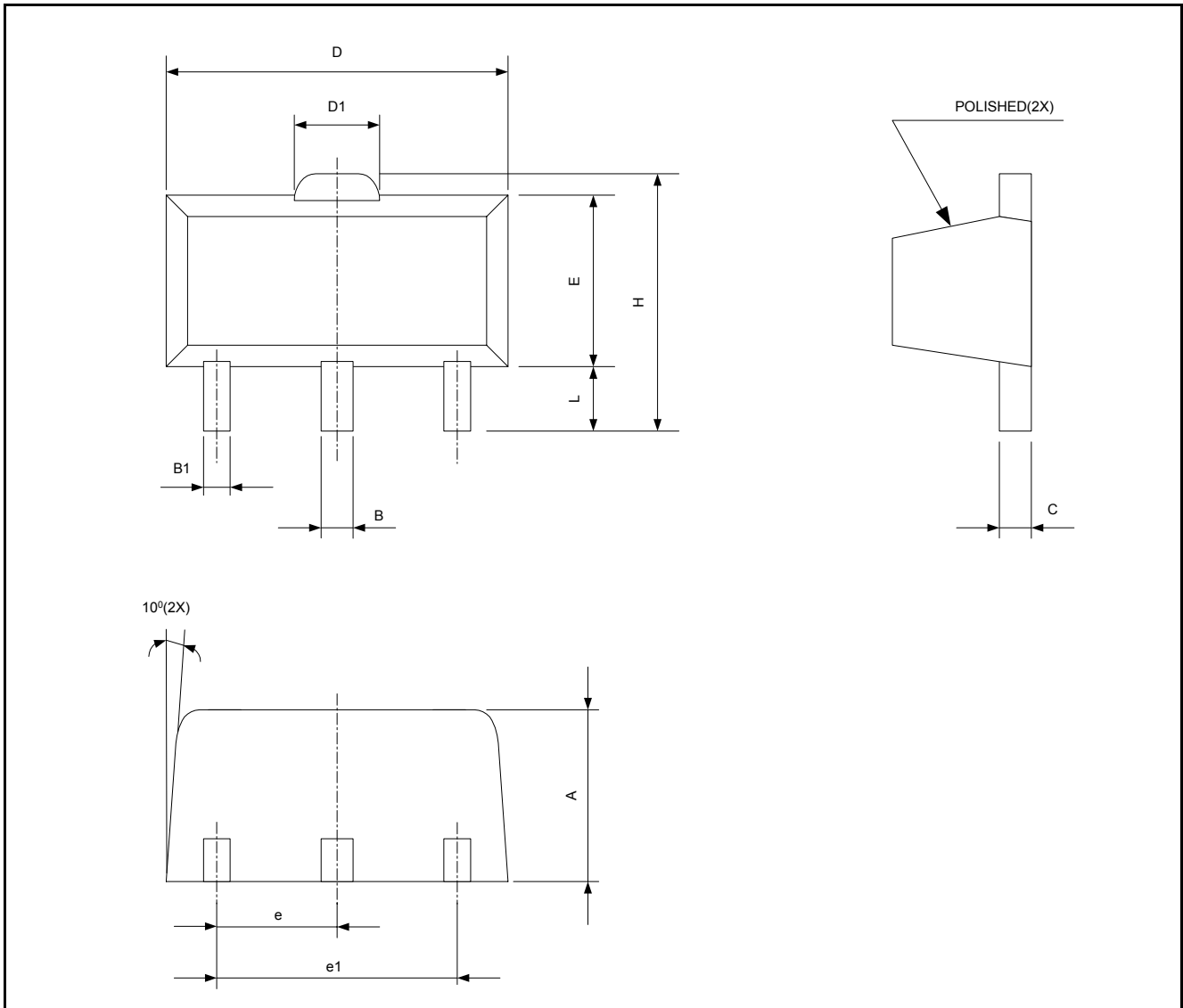

Symbol	Min.	Max.	Unit
A	1.40	1.60	Millimeter
B	0.44	0.56	Millimeter
B1	0.36	0.48	Millimeter
C	0.35	0.44	Millimeter
D	4.40	4.60	Millimeter
D1	1.35	1.83	Millimeter
E	2.29	2.60	Millimeter
H	3.94	4.25	Millimeter
e	1.50 BSC		Millimeter
e1	3.00 BSC		Millimeter
L	0.89	1.2	Millimeter

9. DISCLAIMER

The information appearing in this publication is believed to be accurate.

Integrated circuits sold by Sunplus Technology are covered by the warranty and patent indemnification provisions stipulated in the terms of sale only. SUNPLUS makes no warranty, express, statutory implied or by description regarding the information in this publication or regarding the freedom of the described chip(s) from patent infringement. FURTHERMORE, SUNPLUS MAKES NO WARRANTY OF MERCHANTABILITY OR FITNESS FOR ANY PURPOSE. SUNPLUS reserves the right to halt production or alter the specifications and prices at any time without notice. Accordingly, the reader is cautioned to verify that the data sheets and other information in this publication are current before placing orders. Products described herein are intended for use in normal commercial applications. Applications involving unusual environmental or reliability requirements, e.g. military equipment or medical life support equipment, are specifically not recommended without additional processing by SUNPLUS for such applications. Please note that application circuits illustrated in this document are for reference purposes only.

10. REVISION HISTORY

Date	Revision #	Description	Page
JUL. 10, 2002	0.1	Original	12
OCT.15, 2002	0.2	1. Update quiescent current = 3.0 μ A in Features	3
		2. Update quiescent current = 3.0 μ A in DC characteristic	5
		3. Add $V_{OUT} = 3.3V$ into test conditions of DC characteristic	5
		4. Add Note1 figure into bonding option	5
		5. Add typical operating characteristic figures from page 6 to page 9 (6.4.1 ~ 6.4.17)	6