

PQ05RR12/13

1A Output, Low Power-Loss Voltage Regulators(Built-in Reset Signal Generating Function)

■ Features

- Compact resin full-mold package
- Low power-loss (Dropout voltage : MAX. 0.5V)
- The regulators are provided with reset signal generating function to prevent errors of microcomputer when input voltage is applied and output voltage drops.
- High-precision output type
(Output Voltage precision : $\pm 2.5\%$) (PQ05RR13)

■ Applications

- Series power supply for equipment such as TVs, VCRs and electronic music instruments

■ Outline Dimensions

(Unit : mm)

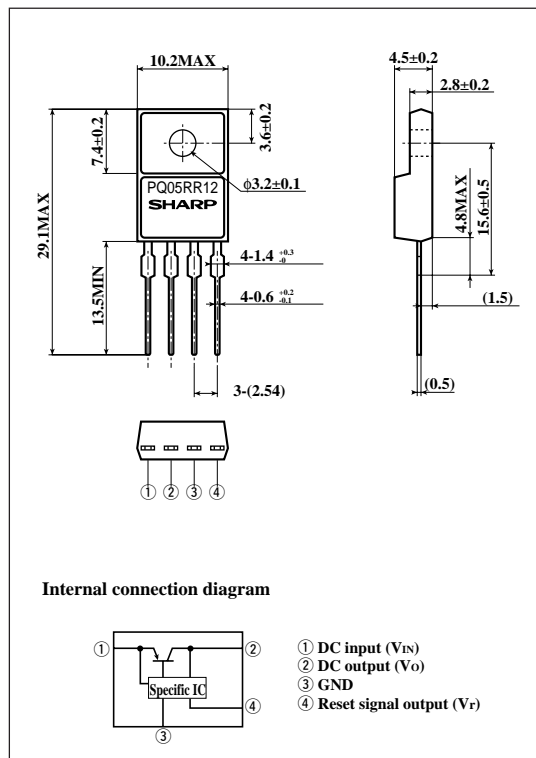

■ Absolute Maximum Ratings

($T_a=25^{\circ}\text{C}$)

Parameter	Symbol	Rating	Unit
*1 Input voltage	V_{IN}	24	V
*1 Reset output voltage	V_r	24	V
Output current	I_O	1	A
Reset output current	I_r	10	mA
Power dissipation (No heat sink)	P_{D1}	1.5	W
*2 Power dissipation (With infinite heat sink)	P_{D2}	15	W
Junction temperature	T_j	150	$^{\circ}\text{C}$
Operating temperature	T_{opr}	-20 to +80	$^{\circ}\text{C}$
Storage temperature	T_{stg}	-40 to +150	$^{\circ}\text{C}$
*3 Soldering temperature	T_{sol}	260	$^{\circ}\text{C}$

*1 All are open except GND and applicable terminals.

*2 Overheat protection may operate at $125 < T_j < 150^{\circ}\text{C}$.

*3 For 10s

· Please refer to the chapter "Handling Precautions".

SHARP

" In the absence of confirmation by device specification sheets, SHARP takes no responsibility for any defects that may occur in equipment using any SHARP devices shown in catalogs, data books, etc. Contact SHARP in order to obtain the latest version of the device specification sheets before using any SHARP's device. "

■ Electrical Characteristics

(Unless otherwise specified, condition shall be $V_{IN}=7V, I_o=0.5A, T_a=25^{\circ}C$)

Parameter	Symbol	Conditions	MIN.	TYP.	MAX.	Unit
Output voltage	V_o	-	4.75	5.0	5.25	V
			4.88	5.0	5.12	
Load regulation	R_{egL}	$I_o=5mA$ to 1.0A	-	0.1	2.0	%
Line regulation	R_{egI}	$V_{IN}=6$ to 12V	-	0.5	2.5	%
Temperature coefficient of output voltage	$T_c V_o$	$T_J=0$ to $125^{\circ}C$	-	± 0.02	-	%/°C
Ripple rejection	RR	Refer to Fig. 2	45	55	-	dB
Dropout voltage	V_{i-o}	*4	-	-	0.5	V
Low reset output voltage	V_{rl}	$I_o=5mA, I_r=5mA$	-	-	0.8	V
Reset threshold voltage	V_{rt}	$I_o=5mA, ^*5$	3.55	3.75	3.95	V
Reset output leak current	I_{rlk}	$I_o=5mA, V_r=24V$	-	-	30	μA
Quiescent current	I_q	$I_o=0$	-	-	10	mA

*4 Input voltage shall be the value when output voltage is 95% in comparison with the initial value.

*5 Output voltage shall be the value when input voltage lowers and V_r becomes low.

Fig.1 Test Circuit

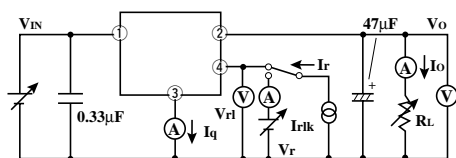
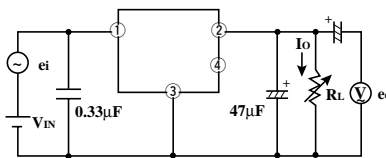
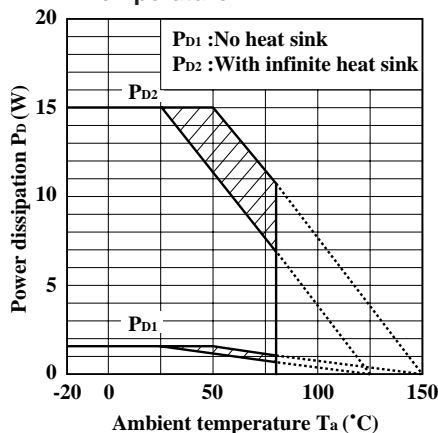

Fig.2 Test Circuit of Ripple Rejection



$f=120Hz$ (sine wave)
 $e_i=0.5V_{rms}$
 $RR=20 \log (e_i/e_o)$

Fig.3 Power Dissipation vs. Ambient Temperature



Note) Oblique line portion: Overheat protection may operate in this area.

Fig.4 Overcurrent Protection Characteristics (Typical value)

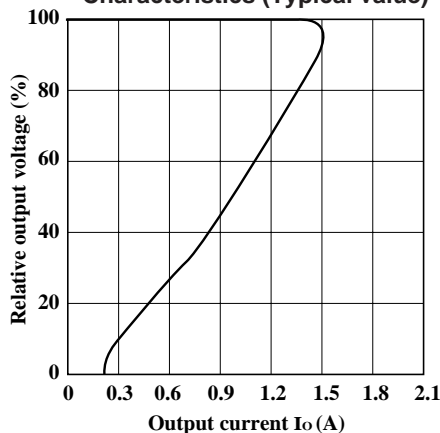

Fig.5 Output Voltage Deviation vs. Junction Temperature

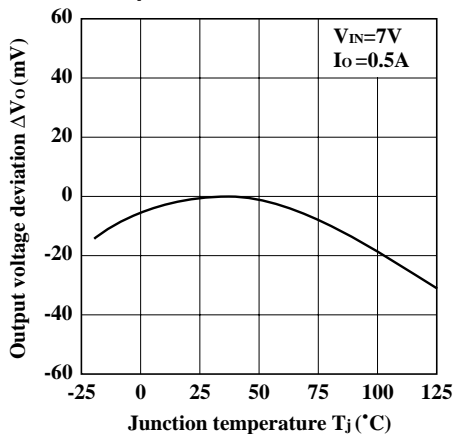

Fig.6 Output Voltage vs. Input Voltage

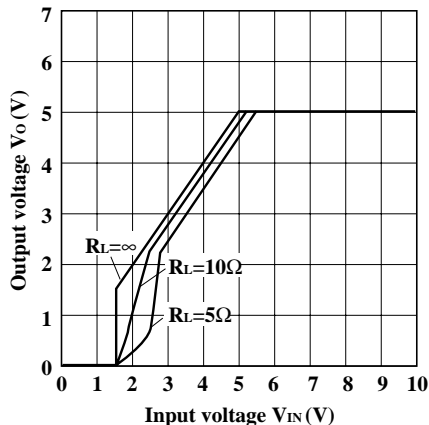

Fig.7 Circuit Operating Current vs. Input Voltage

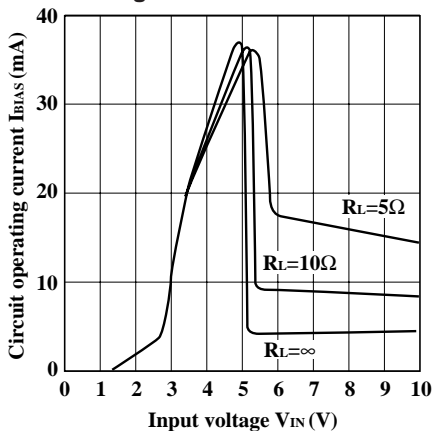

Fig.8 Quiescent Current vs. Junction Temperature

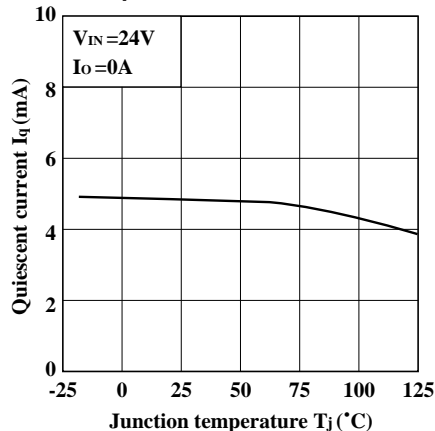

Fig.9 Ripple Rejection vs. Input Ripple Frequency

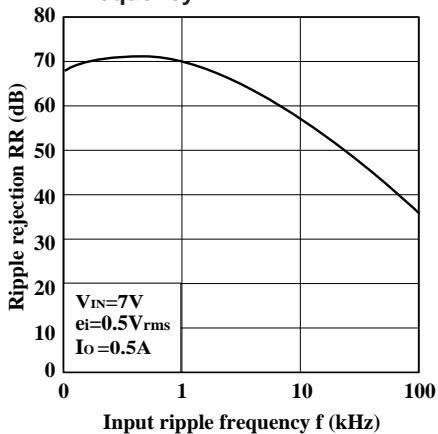

Fig.10 Ripple Rejection vs. Output Current

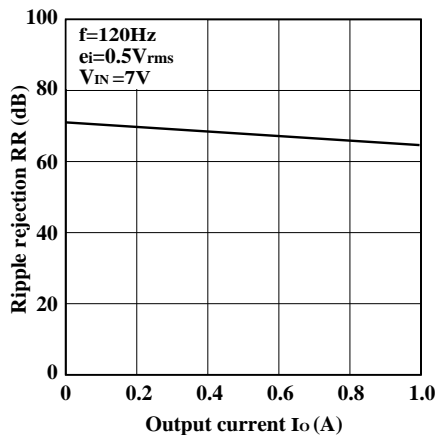

Fig.11 Output Peak Current vs. Junction Temperature

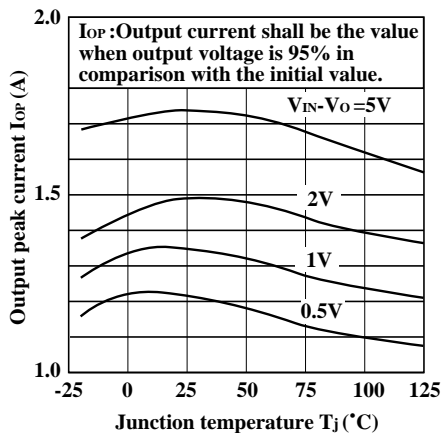

Fig.12 Output Peak Current vs. Dropout Voltage

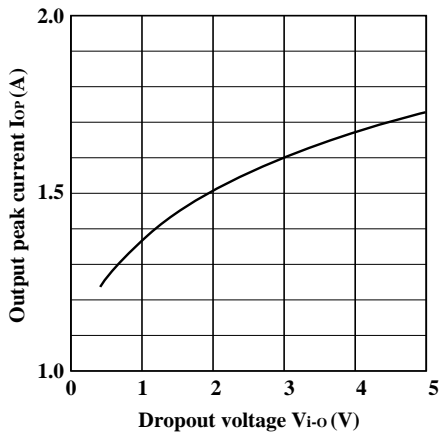
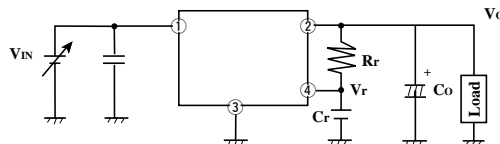
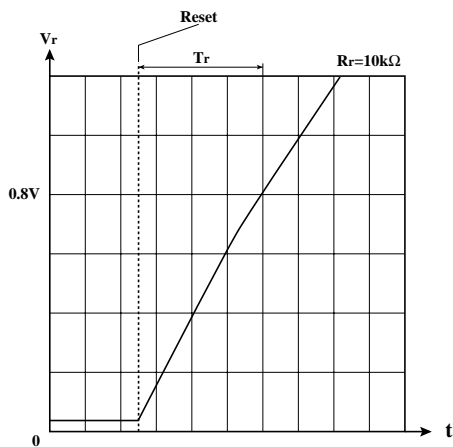
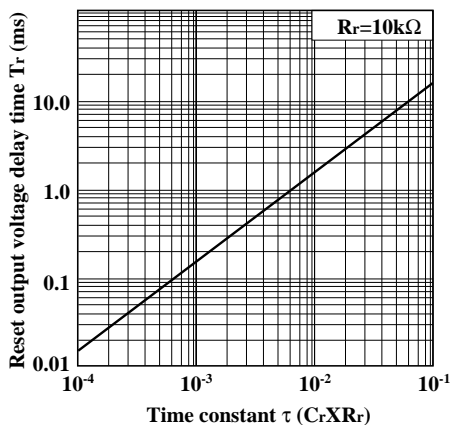
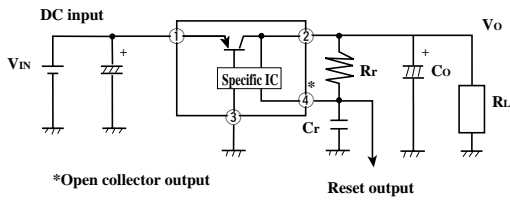

Fig.13 Reset Output Delay Time vs. Time Constant



■ Typical Application



■ Reset Output Response Characteristics

