

**SANYO**

No. 4326

**LC3664BL, BML-70/85/10/12****64 K (8192 words x 8 bits) SRAM**

## Overview

The LC3664BL, BML-70/85/10/12 are fully asynchronous silicon gate CMOS static RAMs with an 8192 words x 8 bits.

This series has  $\overline{CE1}$  and  $\overline{CE2}$  chip enable pins for device select/nonselect control and an  $\overline{OE}$  output enable pin for output control, and features high speed as well as low power dissipation.

For these reasons, the series is especially suited for use in systems requiring high speed, low power, and battery backup, and it is easy to expand memory capacity.

## Features

### • Access time

70 ns (max.) : LC3664BL-70, LC3664BML-70

85 ns (max.) : LC3664BL-85, LC3664BML-85

100 ns (max.) : LC3664BL-10, LC3664BML-10

120 ns (max.) : LC3664BL-12, LC3664BML-12

### • Low current dissipation

#### During standby

0.5  $\mu$ A (max.) /  $T_a = 25^\circ\text{C}$

1  $\mu$ A (max.) /  $T_a = 0$  to  $40^\circ\text{C}$

6  $\mu$ A (max.) /  $T_a = 0$  to  $70^\circ\text{C}$

#### During data retention

0.2  $\mu$ A (max.) /  $T_a = 25^\circ\text{C}$

0.5  $\mu$ A (max.) /  $T_a = 0$  to  $40^\circ\text{C}$

2.5  $\mu$ A (max.) /  $T_a = 0$  to  $70^\circ\text{C}$

#### During operation (DC)

10 mA (max.)

- Single 5 V power supply:  $5\text{ V} \pm 10\%$
- Data retention power supply voltage: 2.0 to 5.5 V
- No clock required (Fully static memory)
- All input/output levels are TTL compatible
- Common input/output pins, with three output states
- Packages
  - DIP 28-pin plastic package (600 mil) : LC3664BL
  - SOP 28-pin plastic package (450 mil) : LC3664BML

## Package Dimensions

unit : mm

### 3012A - DIP28

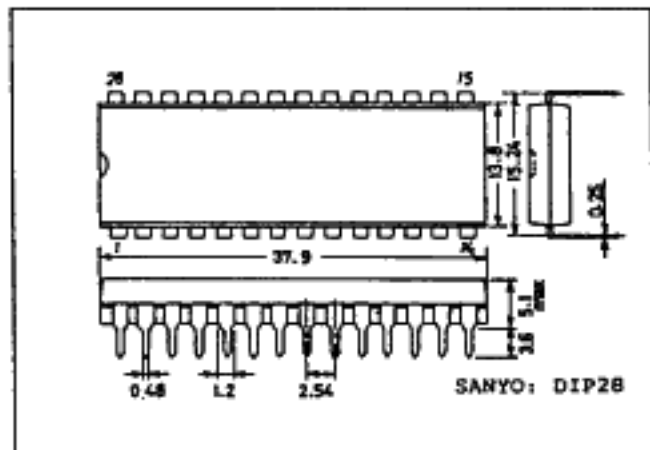

### 3187 - SOP28D

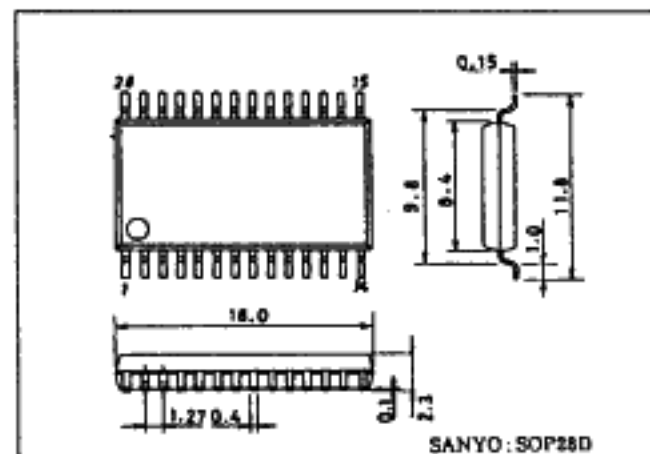

Information (including circuit diagrams and circuit parameters) herein is for example only; it is not guaranteed for volume production.

SANYO believes information herein is accurate and reliable, but no guarantee is made or implied regarding its use or any infringement of intellectual property rights or other rights of third parties.

Specifications and information herein are subject to change without notice.

**SANYO Electric Co., Ltd. Semiconductor Business Headquarters**

TOKYO OFFICE, Tokyo Bldg., 1-10, 1 Chome, Ueno, Taito-ku, TOKYO JAPAN

Pin Assignment

Block Diagram

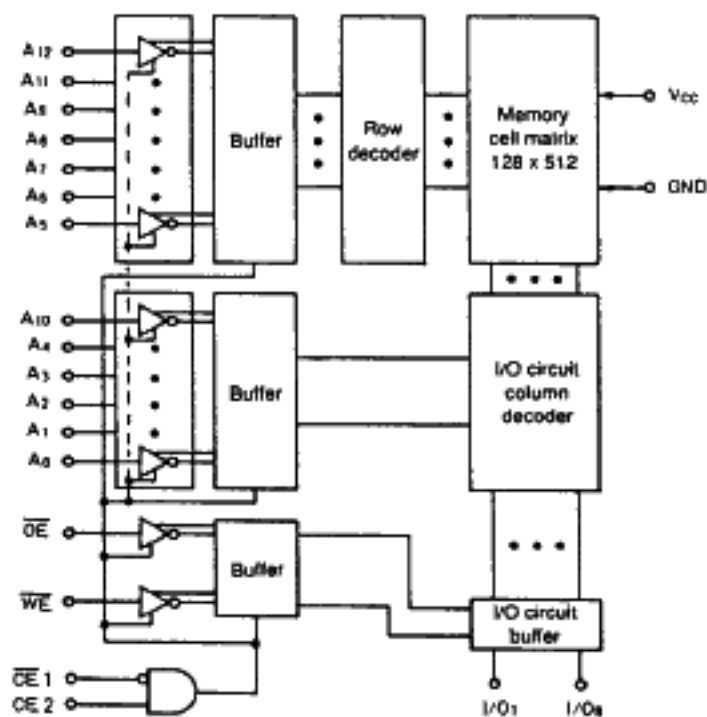

- A0 to A12 : Address input
- WE : Read/write control input
- OE : Output enable input
- CE1, CE2 : Chip enable input
- I/O1 to I/O8 : Data input/output
- Vcc, GND : Power supply pins

Functions

Mode	CE 1	CE 2	OE	WE	I/O	Supply current
Read cycle	L	H	L	H	Data output	ICCA
Write cycle	L	H	X	L	Data input	ICCA
Output disable	L	H	H	H	High impedance	ICCA
Nonselect	H	X	X	X	High impedance	ICCS
	X	L	X	X	High impedance	ICCS

X : H or L

## Specifications

### Absolute Maximum Ratings at $T_a=25^\circ\text{C}$

Parameter	Symbol	Condition	Rating	unit
Maximum supply voltage	$V_{CC\ max}$		7.0	V
Input pin voltage	$V_{IH}$		-0.5* to $V_{CC}+0.5$	V
I/O pin voltage	$V_{IO}$		-0.5* to $V_{CC}+0.5$	V
Allowable power dissipation	$P_d\ max$	LC3664BL	1.0	W
		LC3664BML	0.7	W
Operating temperature range	$T_{opg}$		0 to 70	$^\circ\text{C}$
Storage temperature range	$T_{stg}$		-55 to +150	$^\circ\text{C}$

\* -3.0 V when pulse width is less than 50 ns

### DC Allowable Operating Ranges at $T_a = 0$ to $70^\circ\text{C}$

Parameter	Symbol	min	typ	max	unit
Power supply voltage	$V_{CC}$	4.5	5.0	5.5	V
Input "H" level voltage	$V_{IH}$	2.2		$V_{CC}+0.3$	V
Input "L" level voltage	$V_{IL}$	-0.3*		+0.8	V

\* -3.0 V when pulse width is less than 50 ns

### DC Electrical Characteristics at $T_a = 0$ to $70^\circ\text{C}$ , $V_{CC} = 5\text{ V} \pm 10\%$

Parameter	Symbol	Condition	min	typ*	max	unit	
Input leakage current	$I_{II}$	$V_{IN} = 0$ to $V_{CC}$	-0.5		+0.5	$\mu\text{A}$	
I/O leakage current	$I_{LO}$	$V_{CE1} = V_{IH}$ or $V_{CE2} = V_{IL}$ or $V_{OE} = V_{IH}$ or $V_{WE} = V_{IL}$ , $V_{IO} = 0$ to $V_{CC}$	-0.5		+0.5	$\mu\text{A}$	
Output "H" level voltage	$V_{OH}$	$I_{OH} = -1.0\text{mA}$	2.4			V	
Output "L" level voltage	$V_{OL}$	$I_{OL} = 2.1\text{mA}$			0.4	V	
Operating supply current (DC)	$I_{CCA1}$	$V_{CE1} \leq 0.2\text{V}$ , $V_{CE2} \geq V_{CC} - 0.2\text{V}$ , $V_{IN} \leq 0.2\text{V}$ or $V_{IN} \geq V_{CC} - 0.2\text{V}$ , $I_{IO} = 0\text{mA}$		1	5	mA	
	$I_{CCA2}$	$V_{CE1} = V_{IL}$ , $V_{CE2} = V_{IH}$ , $I_{IO} = 0\text{mA}$ , $V_{IN} = V_{IH}$ or $V_{IL}$		3	10	mA	
Average operating supply current	$I_{CCA3}$	$V_{CE1} = V_{IL}$ , $V_{CE2} = V_{IH}$ , $I_{IO} = 0\text{mA}$ , min cycle	Access time	70ns	30	50	mA
				85ns	25	50	
				100ns	23	50	
				120ns	20	50	
Standby supply current	$I_{CCS1}$	$\{V_{CE2} \leq 0.2\text{V}\}$ or $\{V_{CE1} \geq V_{CC} - 0.2\text{V}, (V_{CE2} \geq V_{CC} - 0.2\text{V} \text{ or } V_{CE2} \leq 0.2\text{V})\}$	0 to $70^\circ\text{C}$	0.2	6	$\mu\text{A}$	
			0 to $40^\circ\text{C}$		1		
			$25^\circ\text{C}$		0.5		
	$I_{CCS2}$	$V_{CE2} = V_{IL}$ or $V_{CE1} = V_{IH}$ , $V_{IN} = 0$ to $V_{CC}$		0.4	2	mA	

\* Reference values at  $V_{CC} = 5\text{ V}$ ,  $T_a = 25^\circ\text{C}$

Input/Output Capacitance at  $T_a = 25^\circ\text{C}$ ,  $f = 1\text{ MHz}$ 

Parameter	Symbol	Condition	min	typ	max	unit
Input/output capacitance	$C_{i/o}$	$V_{i/o} = 0\text{V}$			8	pF
Input capacitance	$C_{iN}$	$V_{iN} = 0\text{V}$			6	pF

Note: These parameters were obtained through sampling, and not full-lot measurement.

AC Electrical Characteristics at  $T_a = 0$  to  $70^\circ\text{C}$ ,  $V_{CC} = 5\text{ V} \pm 10\%$ 

## AC testing conditions

Input pulse voltage level	: 0.8 V, 2.2 V
Input rise and fall time	: 5 ns
Input - output timing level	: 1.5 V
Output load	: 1 TTL gate + $C_L = 100\text{ pF}$ (85 ns/100 ns/120 ns) 1 TTL gate + $C_L = 30\text{ pF}$ (70 ns) (including scope and jig capacitance)

## Read Cycle

Parameter	Symbol	LC3664BL-70 LC3664BML-70		LC3664BL-85 LC3664BML-85		LC3664BL-10 LC3664BML-10		LC3664BL-12 LC3664BML-12		unit
		min	max	min	max	min	max	min	max	
Read cycle time	t <sub>RC</sub>	70		85		100		120		ns
Address access time	t <sub>AA</sub>		70		85		100		120	ns
CE1 access time	t <sub>CA1</sub>		70		85		100		120	ns
CE2 access time	t <sub>CA2</sub>		70		85		100		120	ns
OE access time	t <sub>OA</sub>		35		45		50		60	ns
Output hold time	t <sub>OH</sub>	20		20		20		20		ns
CE1 output enable time	t <sub>COE1</sub>	10		10		10		10		ns
CE2 output enable time	t <sub>COE2</sub>	10		10		10		10		ns
OE output enable time	t <sub>OOE</sub>	5		5		5		5		ns
CE1 output disable time	t <sub>COD1</sub>	0	30	0	30	0	30	0	30	ns
CE2 output disable time	t <sub>COD2</sub>	0	30	0	30	0	30	0	30	ns
OE output disable time	t <sub>OOD</sub>	0	30	0	30	0	30	0	30	ns

## Write Cycle

Parameter	Symbol	LC3664BL-70 LC3664BML-70		LC3664BL-85 LC3664BML-85		LC3664BL-10 LC3664BML-10		LC3664BL-12 LC3664BML-12		unit
		min	max	min	max	min	max	min	max	
Write cycle time	t <sub>WC</sub>	70		85		100		120		ns
Address valid to end of write	t <sub>AW</sub>	60		60		75		85		ns
Address setup time	t <sub>AS</sub>	0		0		0		0		ns
Write pulse width	t <sub>WP</sub>	50		50		60		70		ns
CE1 setup time	t <sub>CW1</sub>	60		60		75		85		ns
CE2 setup time	t <sub>CW2</sub>	60		60		75		85		ns
Write recovery time	t <sub>WR</sub>	0		0		0		0		ns
CE1 Write recovery time	t <sub>WR1</sub>	0		0		0		0		ns
CE2 Write recovery time	t <sub>WR2</sub>	0		0		0		0		ns
Data setup time	t <sub>DS</sub>	30		30		35		40		ns
Data hold time	t <sub>DH</sub>	0		0		0		0		ns
CE1 Data hold time	t <sub>DH1</sub>	0		0		0		0		ns
CE2 Data hold time	t <sub>DH2</sub>	0		0		0		0		ns
WE output enable time	t <sub>WOE</sub>	10		10		10		10		ns
WE output disable time	t <sub>WOD</sub>	0	25	0	25	0	25	0	25	ns

Timing Charts

- Read Cycle (1):  $\overline{CE1} = \overline{OE} = V_{IL}$ ,  $CE2 = V_{IH}$ ,  $\overline{WE} = V_{IH}$

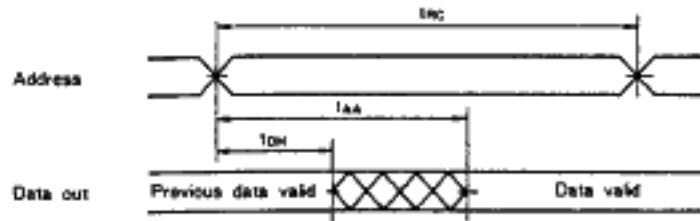

- Read Cycle (2):  $\overline{WE} = V_{IH}$

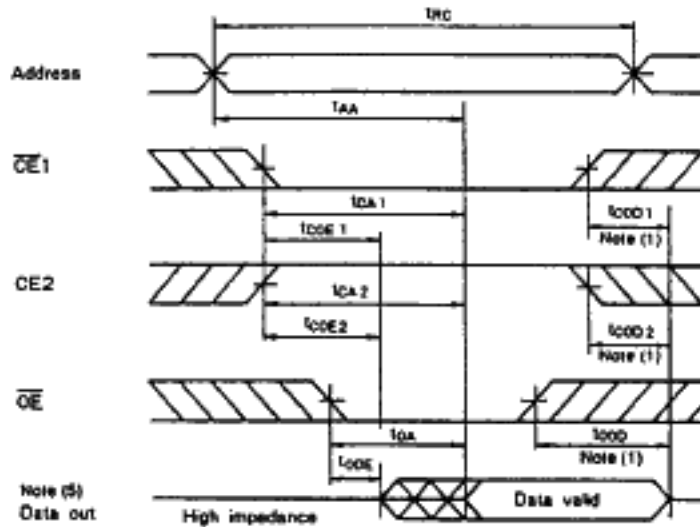

- Write Cycle (1):  $\overline{WE}$  Control Note (6)

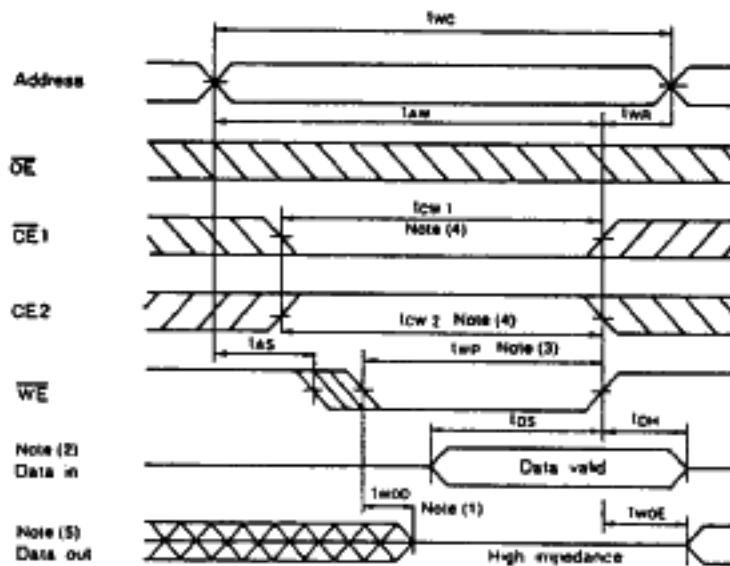

• Write Cycle (2):  $\overline{CE1}$  Control Note (6)

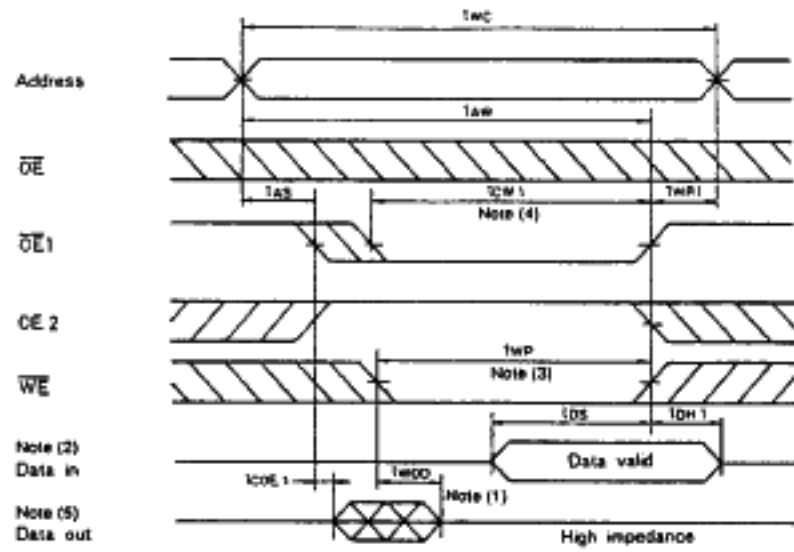

• Write Cycle (3):  $\overline{CE2}$  Control Note (6)

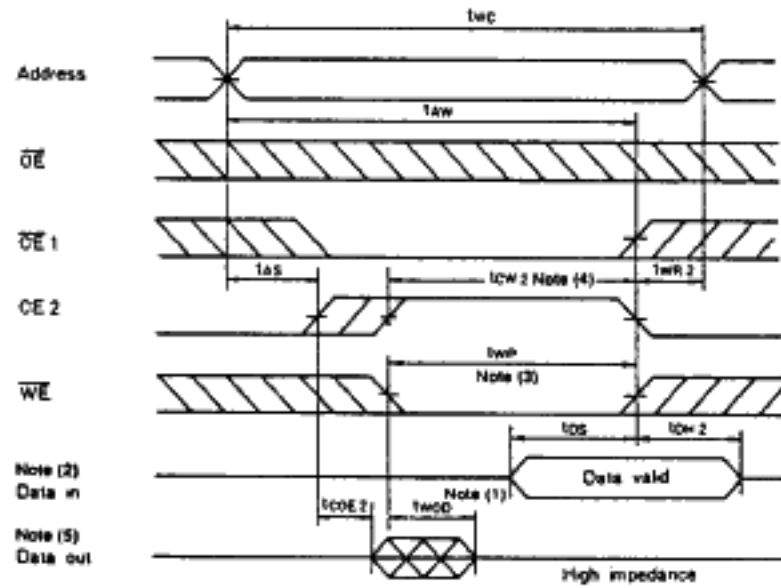

- Notes
- (1)  $t_{COD1}$ ,  $t_{COD2}$ ,  $t_{OOD}$ , and  $t_{WOD}$  are defined as the time at which the outputs becomes the high impedance state and are not referred to output voltage levels.
  - (2) An external antiphase signal must not be applied when DOUT is in the output state.
  - (3)  $t_{WP}$  is the time interval that  $\overline{CE1}$  and  $\overline{WE}$  are low-level and CE2 is high-level, and is defined as the interval from the falling of  $\overline{WE}$  to the rising of  $\overline{CE1}$  or  $\overline{WE}$ , or the falling of CE2, whichever is earlier.
  - (4)  $t_{CW1}$  and  $t_{CW2}$  are the time interval that  $\overline{CE1}$  and  $\overline{WE}$  are low-level and CE2 is high-level, and is defined as the time from the falling of  $\overline{CE1}$  or the rising of CE2 to the rising of  $\overline{CE1}$  or  $\overline{WE}$ , or the falling of CE2, whichever is earlier.
  - (5) DOUT goes to the high-impedance state when either  $\overline{OE}$  is high-level,  $\overline{CE1}$  is high-level, CE2 is low-level, or  $\overline{WE}$  is low-level.
  - (6) When  $\overline{OE}$  is high-level during the write cycle, DOUT goes to the high-impedance state.

**Data Retention Characteristics at Ta = 0 to 70°C**

Parameter	Symbol	Condition	min	typ	max	unit
Data retention supply voltage	$V_{DR1}$	$V_{CE2} \geq V_{CC} - 0.2V$ , $V_{CE1} \geq V_{CC} - 0.2V$ or $V_{CE2} \leq 0.2V$	2.0		5.5	V
	$V_{DR2}$	$V_{CE2} \leq 0.2V$	2.0		5.5	V
Data retention supply current	$I_{CCDR1}$	$V_{CC} = 3.0V$ , $V_{CE1} \geq V_{CC} - 0.2V$ , $V_{CE2} \geq V_{CC} - 0.2V$ or $V_{CE2} \leq 0.2V$	0 to 70°C		2.5	$\mu A$
			0 to 40°C		0.5	
			25°C		0.2	
	$I_{CCDR2}$	$V_{CC} = 3.0V$ , $V_{CE2} \leq 0.2V$	0 to 70°C		2.5	$\mu A$
			0 to 40°C		0.5	
			25°C		0.2	
Chip enable setup time	$t_{CDR}$		0			ns
Chip enable hold time	$t_R$		$t_{RC}^*$			ns

\*  $t_{RC}$  = Read Cycle time

**Data Retention Waveform (1) ( $\overline{CE1}$  control)**

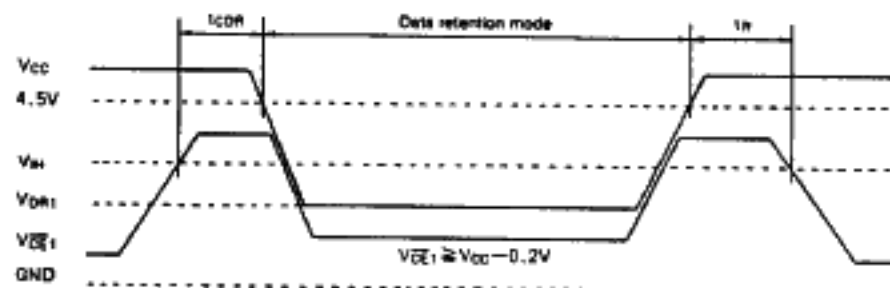

**Data Retention Waveform (2) (CE2 control)**

