



# 50ppm/°C Precision Micropower Shunt Voltage References with Multiple Reverse Breakdown Voltages

## General Description

The LM4050/LM4051 are precision two-terminal, shunt-mode, bandgap voltage references available in fixed reverse breakdown voltages of 1.225V, 2.048V, 2.500V, 3.000V, 3.3V, 4.096V, and 5.000V. Ideal for space-critical applications, the LM4050/LM4051 are offered in the subminiature 3-pin SC70 surface-mount packages (1.8mm x 1.8mm), 50% smaller than comparable devices in SOT23 surface-mount package (SOT23 versions are also available).

Laser-trimmed resistors ensure excellent initial accuracy. With a 50ppm/°C temperature coefficient, these devices are offered in three grades of initial accuracy ranging from 0.1% to 0.5%. The LM4050/LM4051 have a 60µA to 15mA shunt-current capability with low dynamic impedance, ensuring stable reverse breakdown voltage accuracy over a wide range of operating temperatures and currents. The LM4050/LM4051 do not require an external stabilizing capacitor while ensuring stability with any capacitive loads.

The LM4050/LM4051 specifications are guaranteed over the temperature range of -40°C to +125°C.

## Applications

Portable, Battery-Powered Equipment  
 Notebook Computers  
 Cell Phones  
 Industrial Process Controls

## Typical Operating Circuit

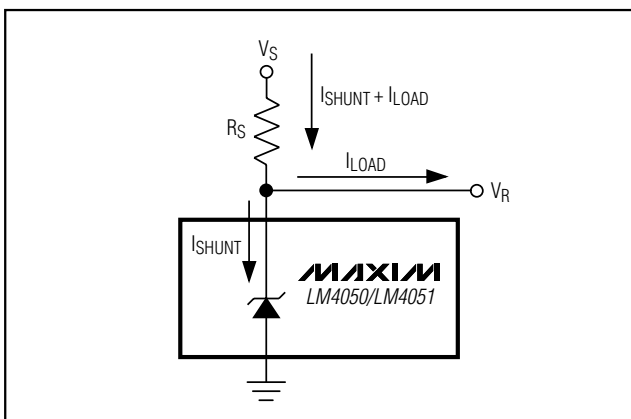

## Features

- ◆ 50ppm/°C (max) Temperature Coefficient Guaranteed over the -40°C to +125°C Temperature Range
- ◆ Ultra-Small 3-Pin SC70 Package
- ◆ 0.1% (max) Initial Accuracy
- ◆ Wide Operating Current Range: 60µA to 15mA
- ◆ Low 28µVRMS Output Noise (10Hz to 10kHz)
- ◆ 1.225V, 2.048V, 2.500V, 3.000V, 3.3V, 4.096V, and 5.000V Fixed Reverse Breakdown Voltages
- ◆ No Output Capacitors Required
- ◆ Tolerates Capacitive Loads

## Selector Guide

PART	TEMP RANGE	PIN-PACKAGE	OUTPUT VOLTAGE (V)
LM4050_IM3-2.1	-40°C to +125°C	3 SOT23-3	2.048
LM4050_IX3-2.1	-40°C to +125°C	3 SC70-3	2.048
LM4050_IM3-2.5	-40°C to +125°C	3 SOT23-3	2.500
LM4050_IX3-2.5	-40°C to +125°C	3 SC70-3	2.500
LM4050_IM3-3.0	-40°C to +125°C	3 SOT23-3	3.000
LM4050_IX3-3.0	-40°C to +125°C	3 SC70-3	3.000
LM4050_EX3-3.3	-40°C to +125°C	3 SC70-3	3.300
LM4050_IM3-4.1	-40°C to +125°C	3 SOT23-3	4.096
LM4050_IX3-4.1	-40°C to +125°C	3 SC70-3	4.096
LM4050_IM3-5.0	-40°C to +125°C	3 SOT23-3	5.000
LM4050_IX3-5.0	-40°C to +125°C	3 SC70-3	5.000
LM4051_IM3-1.2	-40°C to +125°C	3 SOT23-3	1.225
LM4051_IX3-1.2	-40°C to +125°C	3 SC70-3	1.225

Ordering Information appears at end of data sheet.

## Pin Configuration

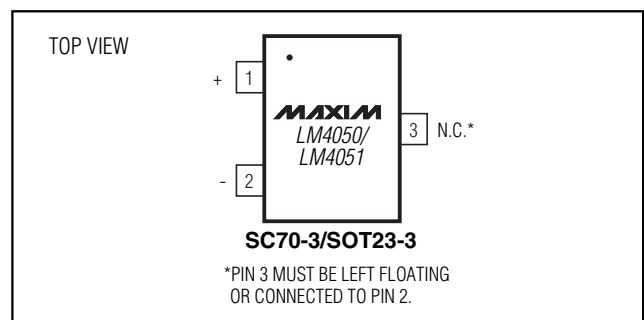

# 50ppm/°C Precision Micropower Shunt Voltage References with Multiple Reverse Breakdown Voltages

## ABSOLUTE MAXIMUM RATINGS

Reverse Current (cathode to anode) .....20mA  
 Forward Current (anode to cathode) .....10mA  
 ESD per Method 3015.7  
   Human Body Model .....2000V  
   Machine Model.....200V  
 Continuous Power Dissipation (T<sub>A</sub> = +70°C)  
   3-Pin SC70 (derate 2.17mW/°C above +70°C).....174mW  
   3-Pin SOT23 (derate 4.01mW/°C above +70°C).....320mW

Operating Temperature Range  
 LM4050/LM4051\_I\_ \_ .....-40°C to +125°C  
 Storage Temperature Range .....-65°C to +150°C  
 Junction Temperature .....+150°C  
 Lead Temperature (soldering, 10s).....+300°C

Stresses beyond those listed under "Absolute Maximum Ratings" may cause permanent damage to the device. These are stress ratings only, and functional operation of the device at these or any other conditions beyond those indicated in the operational sections of the specifications is not implied. Exposure to absolute maximum rating conditions for extended periods may affect device reliability.

## ELECTRICAL CHARACTERISTICS—1.225V

(I<sub>R</sub> = 100μA, T<sub>A</sub> = T<sub>MIN</sub> to T<sub>MAX</sub>, unless otherwise noted. Typical values are at T<sub>A</sub> = +25°C.) (Note 1)

PARAMETER	SYMBOL	CONDITIONS	MIN	TYP	MAX	UNITS	
Reverse Breakdown Voltage	V <sub>R</sub>	T <sub>A</sub> = +25°C	LM4051A (0.1%)	1.2238	1.2250	1.2262	V
			LM4051B (0.2%)	1.2226	1.2250	1.2275	
			LM4051C (0.5%)	1.2189	1.2250	1.2311	
Reverse Breakdown Voltage Tolerance (Note 2)	V <sub>RTOL</sub>	LM4051A		±1.2	±7	mV	
		LM4051B		±2.4	±9		
		LM4051C		±6.0	±12		
Minimum Operating Current	I <sub>RMIN</sub>		45	60		μA	
Average Reverse Voltage Temperature Coefficient (Notes 2, 3)	ΔV <sub>R</sub> /ΔT	I <sub>R</sub> = 10mA		±20		ppm/°C	
		I <sub>R</sub> = 1mA		±15	±50		
		I <sub>R</sub> = 100μA		±15			
Reverse Breakdown Voltage Change with Operating Current Change		I <sub>RMIN</sub> ≤ I <sub>R</sub> ≤ 1mA		0.7	1.5	mV	
		1mA ≤ I <sub>R</sub> ≤ 12mA		2.5	8.0		
Reverse Dynamic Impedance (Note 3)	Z <sub>R</sub>	I <sub>R</sub> = 1mA, f = 120Hz, I <sub>AC</sub> = 0.1I <sub>R</sub>		0.5	1.5	Ω	
Wideband Noise	e <sub>N</sub>	I <sub>R</sub> = 100μA, 10Hz ≤ f ≤ 10kHz		20		μV <sub>RMS</sub>	
Reverse Breakdown Voltage Long-Term Stability	ΔV <sub>R</sub>	T = 1000h		120		ppm	

# 50ppm/°C Precision Micropower Shunt Voltage References with Multiple Reverse Breakdown Voltages

**LM4050/LM4051**

## ELECTRICAL CHARACTERISTICS—2.048V

( $I_R = 100\mu\text{A}$ ,  $T_A = T_{\text{MIN}}$  to  $T_{\text{MAX}}$ , unless otherwise noted. Typical values are at  $T_A = +25^\circ\text{C}$ .) (Note 1)

PARAMETER	SYMBOL	CONDITIONS	MIN	TYP	MAX	UNITS	
Reverse Breakdown Voltage	$V_R$	$T_A = +25^\circ\text{C}$	LM4050A (0.1%)	2.0460	2.0480	2.0500	V
			LM4050B (0.2%)	2.0439	2.0480	2.0521	
			LM4050C (0.5%)	2.0378	2.0480	2.0582	
Reverse Breakdown Voltage Tolerance (Note 2)	$V_{\text{RTOL}}$	LM4050A		$\pm 2.0$	$\pm 12$	mV	
		LM4050B		$\pm 4.0$	$\pm 14$		
		LM4050C		$\pm 10$	$\pm 20$		
Minimum Operating Current	$I_{\text{RMIN}}$			45	65	$\mu\text{A}$	
Average Reverse Voltage Temperature Coefficient (Notes 2, 3)	$\Delta V_R/\Delta T$	$I_R = 10\text{mA}$		$\pm 20$		ppm/°C	
		$I_R = 1\text{mA}$		$\pm 15$	$\pm 50$		
		$I_R = 100\mu\text{A}$		$\pm 15$			
Reverse Breakdown Voltage Change with Operating Current Change		$I_{\text{RMIN}} \leq I_R \leq 1\text{mA}$		0.3	1.0	mV	
		$1\text{mA} \leq I_R \leq 15\text{mA}$		2.5	8.0		
Reverse Dynamic Impedance (Note 3)	$Z_R$	$I_R = 1\text{mA}$ , $f = 120\text{Hz}$ , $I_{\text{AC}} = 0.1I_R$	LM4050A/B		0.3	0.8	$\Omega$
			LM4050C		0.3	0.9	
Wideband Noise	$e_N$	$I_R = 100\mu\text{A}$ , $10\text{Hz} \leq f \leq 10\text{kHz}$		28		$\mu\text{VRMS}$	
Reverse Breakdown Voltage Long-Term Stability	$\Delta V_R$	$T = 1000\text{h}$		120		ppm	

# 50ppm/°C Precision Micropower Shunt Voltage References with Multiple Reverse Breakdown Voltages

## ELECTRICAL CHARACTERISTICS—2.500V

( $I_R = 100\mu\text{A}$ ,  $T_A = T_{\text{MIN}}$  to  $T_{\text{MAX}}$ , unless otherwise noted. Typical values are at  $T_A = +25^\circ\text{C}$ .) (Note 1)

PARAMETER	SYMBOL	CONDITIONS		MIN	TYP	MAX	UNITS
Reverse Breakdown Voltage	$V_R$	$T_A = +25^\circ\text{C}$	LM4050A (0.1%)	2.4975	2.5000	2.5025	V
			LM4050B (0.2%)	2.4950	2.5000	2.5050	
			LM4050C (0.5%)	2.4875	2.5000	2.5125	
Reverse Breakdown Voltage Tolerance (Note 2)	$V_{\text{RTOL}}$	LM4050A		$\pm 2.5$	$\pm 15$		mV
		LM4050B		$\pm 5.0$	$\pm 18$		
		LM4050C		$\pm 13$	$\pm 25$		
Minimum Operating Current	$I_{\text{RMIN}}$			45	65		$\mu\text{A}$
Average Reverse Voltage Temperature Coefficient (Notes 2, 3)	$\Delta V_R/\Delta T$	$I_R = 10\text{mA}$		$\pm 20$			ppm/°C
		$I_R = 1\text{mA}$		$\pm 15$	$\pm 50$		
		$I_R = 100\mu\text{A}$		$\pm 15$			
Reverse Breakdown Voltage Change with Operating Current Change		$I_{\text{RMIN}} \leq I_R \leq 1\text{mA}$		0.3	1.0		mV
		$1\text{mA} \leq I_R \leq 15\text{mA}$		2.5	8.0		
Reverse Dynamic Impedance (Note 3)	$Z_R$	$I_R = 1\text{mA}$ , $f = 120\text{Hz}$ , $I_{\text{AC}} = 0.1I_R$	LM4050A/B		0.3	0.8	$\Omega$
			LM4050C		0.3	0.9	
Wideband Noise	$e_N$	$I_R = 100\mu\text{A}$ , $10\text{Hz} \leq f \leq 10\text{kHz}$		35			$\mu\text{V}_{\text{RMS}}$
Reverse Breakdown Voltage Long-Term Stability	$\Delta V_R$	$T = 1000\text{h}$		120			ppm

# 50ppm/°C Precision Micropower Shunt Voltage References with Multiple Reverse Breakdown Voltages

LM4050/LM4051

## ELECTRICAL CHARACTERISTICS—3.000V

( $I_R = 100\mu\text{A}$ ,  $T_A = T_{\text{MIN}}$  to  $T_{\text{MAX}}$ , unless otherwise noted. Typical values are at  $T_A = +25^\circ\text{C}$ .) (Note 1)

PARAMETER	SYMBOL	CONDITIONS		MIN	TYP	MAX	UNITS
Reverse Breakdown Voltage	$V_R$	$T_A = +25^\circ\text{C}$	LM4050A (0.1%)	2.9970	3.0000	3.0030	V
			LM4050B (0.2%)	2.9940	3.0000	3.0060	
			LM4050C (0.5%)	2.9850	3.0000	3.0150	
Reverse Breakdown Voltage Tolerance (Note 2)	$V_{\text{RTOL}}$	LM4050A		$\pm 3.0$	$\pm 18$	mV	
		LM4050B		$\pm 6.0$	$\pm 21$		
		LM4050C		$\pm 15$	$\pm 30$		
Minimum Operating Current	$I_{\text{RMIN}}$			45	67	$\mu\text{A}$	
Average Reverse Voltage Temperature Coefficient (Notes 2, 3)	$\Delta V_R/\Delta T$	$I_R = 10\text{mA}$		$\pm 20$		ppm/°C	
		$I_R = 1\text{mA}$		$\pm 15$	$\pm 50$		
		$I_R = 100\mu\text{A}$		$\pm 15$			
Reverse Breakdown Voltage Change with Operating Current Change		$I_{\text{RMIN}} \leq I_R \leq 1\text{mA}$		0.3	1.0	mV	
		$1\text{mA} \leq I_R \leq 15\text{mA}$		2.5	8.0		
Reverse Dynamic Impedance (Note 3)	$Z_R$	$I_R = 1\text{mA}$ , $f = 120\text{Hz}$ , $I_{\text{AC}} = 0.1I_R$	LM4050A/B		0.3	0.8	$\Omega$
			LM4050C		0.3	0.9	
Wideband Noise	$e_N$	$I_R = 100\mu\text{A}$ , $10\text{Hz} \leq f \leq 10\text{kHz}$		45		$\mu\text{VRMS}$	
Reverse Breakdown Voltage Long-Term Stability	$\Delta V_R$	$T = 1000\text{h}$		120		ppm	

## ELECTRICAL CHARACTERISTICS—3.300V

( $I_R = 100\mu\text{A}$ ,  $T_A = T_{\text{MIN}}$  to  $T_{\text{MAX}}$ , unless otherwise noted. Typical values are at  $T_A = +25^\circ\text{C}$ .) (Note 1)

PARAMETER	SYMBOL	CONDITIONS		MIN	TYP	MAX	UNITS
Reverse Breakdown Voltage	$V_R$	$T_A = +25^\circ\text{C}$	LM4050A (0.1%)	3.2967	3.3000	3.3033	V
			LM4050B (0.2%)	3.2934	3.3000	3.3066	
			LM4050C (0.5%)	3.2835	3.3000	3.3165	
Reverse Breakdown Voltage Tolerance (Note 2)	$V_{\text{RTOL}}$	LM4050A		$\pm 3.0$	$\pm 18$	mV	
		LM4050B		$\pm 6.0$	$\pm 21$		
		LM4050C		$\pm 15$	$\pm 30$		
Minimum Operating Current	$I_{\text{RMIN}}$			45	67	$\mu\text{A}$	
Average Reverse Voltage Temperature Coefficient (Notes 2, 3)	$\Delta V_R/\Delta T$	$I_R = 10\text{mA}$		$\pm 20$		ppm/°C	
		$I_R = 1\text{mA}$		$\pm 15$	$\pm 50$		
		$I_R = 100\mu\text{A}$		$\pm 15$			
Reverse Breakdown Voltage Change with Operating Current Change		$I_{\text{RMIN}} \leq I_R \leq 1\text{mA}$		0.3	1.0	mV	
		$1\text{mA} \leq I_R \leq 15\text{mA}$		2.5	8.0		
Reverse Dynamic Impedance (Note 3)	$Z_R$	$I_R = 1\text{mA}$ , $f = 120\text{Hz}$ , $I_{\text{AC}} = 0.1I_R$	LM4050A/B		0.3	0.8	$\Omega$
			LM4050C		0.3	0.9	
Wideband Noise	$e_N$	$I_R = 100\mu\text{A}$ , $10\text{Hz} \leq f \leq 10\text{kHz}$		50		$\mu\text{VRMS}$	
Reverse Breakdown Voltage Long-Term Stability	$\Delta V_R$	$T = 1000\text{h}$		120		ppm	

# 50ppm/°C Precision Micropower Shunt Voltage References with Multiple Reverse Breakdown Voltages

## ELECTRICAL CHARACTERISTICS—4.096V

( $I_R = 100\mu\text{A}$ ,  $T_A = T_{\text{MIN}}$  to  $T_{\text{MAX}}$ , unless otherwise noted. Typical values are at  $T_A = +25^\circ\text{C}$ .) (Note 1)

PARAMETER	SYMBOL	CONDITIONS	MIN	TYP	MAX	UNITS	
Reverse Breakdown Voltage	$V_R$	$T_A = +25^\circ\text{C}$	LM4050A (0.1%)	4.0919	4.0960	4.1001	V
			LM4050B (0.2%)	4.0878	4.0960	4.1042	
			LM4050C (0.5%)	4.0755	4.0960	4.1165	
Reverse Breakdown Voltage Tolerance (Note 2)	$V_{\text{RTOL}}$	LM4050A		$\pm 4.1$	$\pm 25$	mV	
		LM4050B		$\pm 8.2$	$\pm 29$		
		LM4050C		$\pm 20$	$\pm 41$		
Minimum Operating Current	$I_{\text{RMIN}}$			50	73	$\mu\text{A}$	
Average Reverse Voltage Temperature Coefficient (Notes 2, 3)	$\Delta V_R/\Delta T$	$I_R = 10\text{mA}$		$\pm 30$		ppm/°C	
		$I_R = 1\text{mA}$		$\pm 20$	$\pm 50$		
		$I_R = 100\mu\text{A}$		$\pm 15$			
Reverse Breakdown Voltage Change with Operating Current Change		$I_{\text{RMIN}} \leq I_R \leq 1\text{mA}$		0.5	1.2	mV	
		$1\text{mA} \leq I_R \leq 15\text{mA}$		3.0	10.0		
Reverse Dynamic Impedance (Note 3)	$Z_R$	$I_R = 1\text{mA}$ , $f = 120\text{Hz}$ , $I_{\text{AC}} = 0.1I_R$		0.5	1.0	$\Omega$	
Wideband Noise	$e_N$	$I_R = 100\mu\text{A}$ , $10\text{Hz} \leq f \leq 10\text{kHz}$		64		$\mu\text{VRMS}$	
Reverse Breakdown Voltage Long-Term Stability	$\Delta V_R$	$T = 1000\text{h}$		120		ppm	

# 50ppm/°C Precision Micropower Shunt Voltage References with Multiple Reverse Breakdown Voltages

LM4050/LM4051

## ELECTRICAL CHARACTERISTICS—5.000V

( $I_R = 100\mu\text{A}$ ,  $T_A = T_{\text{MIN}}$  to  $T_{\text{MAX}}$ , unless otherwise noted. Typical values are at  $T_A = +25^\circ\text{C}$ .) (Note 1)

PARAMETER	SYMBOL	CONDITIONS	MIN	TYP	MAX	UNITS	
Reverse Breakdown Voltage	$V_R$	$T_A = +25^\circ\text{C}$	LM4050A (0.1%)	4.9950	5.0000	5.0050	V
			LM4050B (0.2%)	4.9900	5.0000	5.0100	
			LM4050C (0.5%)	4.9750	5.0000	5.0250	
Reverse Breakdown Voltage Tolerance (Note 2)	$V_{\text{RTOL}}$	LM4050A		$\pm 5.0$	$\pm 30$	mV	
		LM4050B		$\pm 10$	$\pm 35$		
		LM4050C		$\pm 25$	$\pm 50$		
Minimum Operating Current	$I_{\text{RMIN}}$			54	80	$\mu\text{A}$	
Average Reverse Voltage Temperature Coefficient (Notes 2, 3)	$\Delta V_R / \Delta T$	$I_R = 10\text{mA}$		$\pm 30$		ppm/°C	
		$I_R = 1\text{mA}$		$\pm 20$	$\pm 50$		
		$I_R = 100\mu\text{A}$		$\pm 15$			
Reverse Breakdown Voltage Change with Operating Current Change		$I_{\text{RMIN}} \leq I_R \leq 1\text{mA}$		0.5	1.4	mV	
		$1\text{mA} \leq I_R \leq 15\text{mA}$		3.5	12.0		
Reverse Dynamic Impedance (Note 3)	$Z_R$	$I_R = 1\text{mA}$ , $f = 120\text{Hz}$ , $I_{\text{AC}} = 0.1I_R$		0.5	1.1	$\Omega$	
Wideband Noise	$e_N$	$I_R = 100\mu\text{A}$ , $10\text{Hz} \leq f \leq 10\text{kHz}$		80		$\mu\text{VRMS}$	
Reverse Breakdown Voltage Long-Term Stability	$\Delta V_R$	$T = 1000\text{h}$		120		ppm	

**Note 1:** All devices are 100% production tested at  $+25^\circ\text{C}$  and are guaranteed by design for  $T_A = T_{\text{MIN}}$  to  $T_{\text{MAX}}$ , as specified.

**Note 2:** The limit over the full temperature range for the reverse breakdown voltage tolerance is defined as:

$$[V_{\text{RTOL}}] \pm [(\Delta V_R / \Delta T) \times (\text{max}\Delta T) \times (V_R)]$$

where  $\Delta V_R / \Delta T$  is the  $V_R$  temperature coefficient,  $\text{max}\Delta T$  is the difference from the  $+25^\circ\text{C}$  reference point to  $T_{\text{MIN}}$  or  $T_{\text{MAX}}$ , and  $V_R$  is the reverse breakdown voltage.

The total tolerance over the full temperature range for the different grades where  $\text{max}\Delta T = +100^\circ\text{C}$  is shown below:

- A grade:  $\pm 0.6\% = \pm 0.1\% \pm 50\text{ppm}/^\circ\text{C} \times 100^\circ\text{C}$
- B grade:  $\pm 0.7\% = \pm 0.2\% \pm 50\text{ppm}/^\circ\text{C} \times 100^\circ\text{C}$
- C grade:  $\pm 1.0\% = \pm 0.5\% \pm 50\text{ppm}/^\circ\text{C} \times 100^\circ\text{C}$

**Note 3:** Guaranteed by design.

# 50ppm/°C Precision Micropower Shunt Voltage References with Multiple Reverse Breakdown Voltages

## Typical Operating Characteristics

( $I_R = 100\mu A$ , SC70-3 package,  $T_A = +25^\circ C$ , unless otherwise noted.)

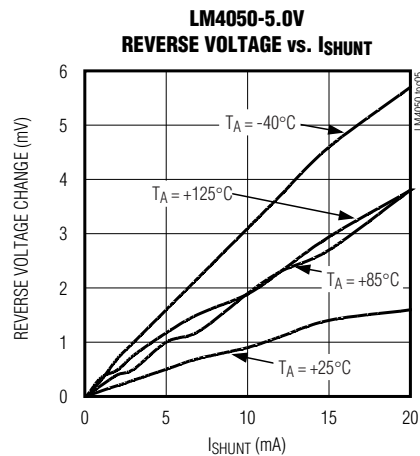
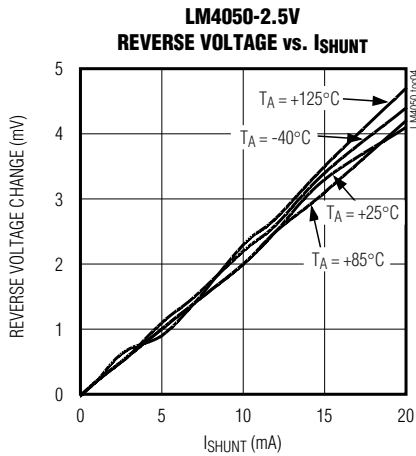
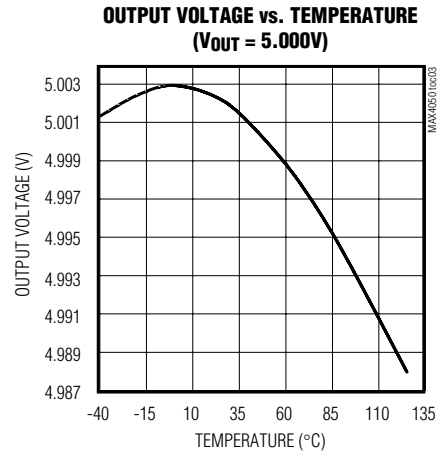
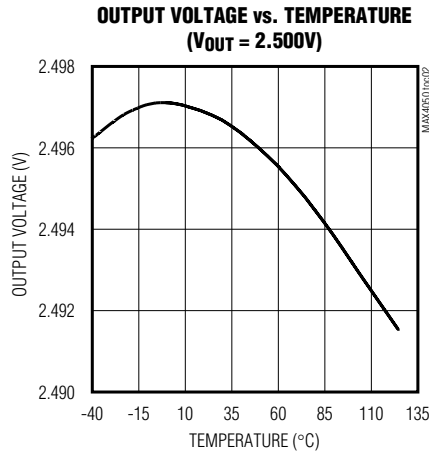
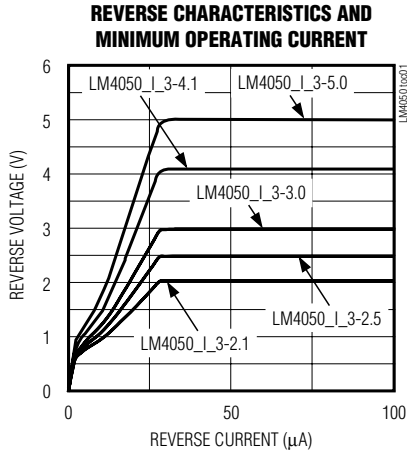



# 50ppm/°C Precision Micropower Shunt Voltage References with Multiple Reverse Breakdown Voltages

## Typical Operating Characteristics (continued)

( $I_R = 100\mu\text{A}$ , SC70-3 package,  $T_A = +25^\circ\text{C}$ , unless otherwise noted.)

LM4050/LM4051

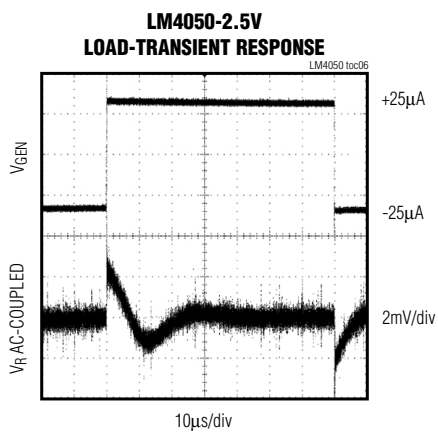

CH1:  $V_{GEN}$  2V/div  
CH2:  $V_R$  AC-COUPLED 2mV/div  
 $I_{SHUNT} = 100\mu\text{A} \pm 25\mu\text{A}$ ,  $R_L = 100\text{k}\Omega$ , SEE FIGURE 1.

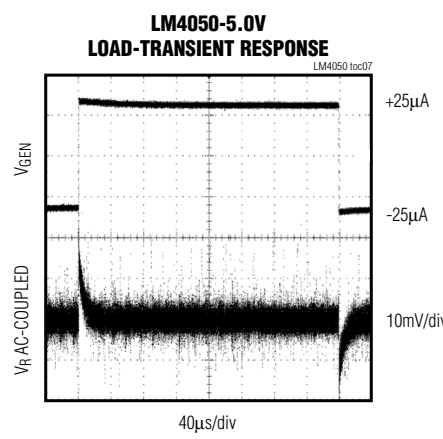

$I_{SHUNT} = 100\mu\text{A} \pm 25\mu\text{A}$   
 $R_L = 100\text{k}\Omega$ , SEE FIGURE 1.

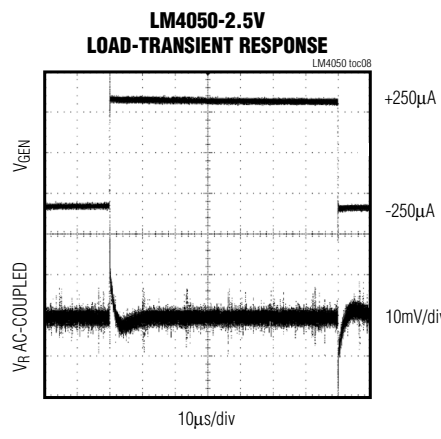

$I_{SHUNT} = 1\text{mA} \pm 250\mu\text{A}$   
 $R_L = 10\text{k}\Omega$ , SEE FIGURE 1.

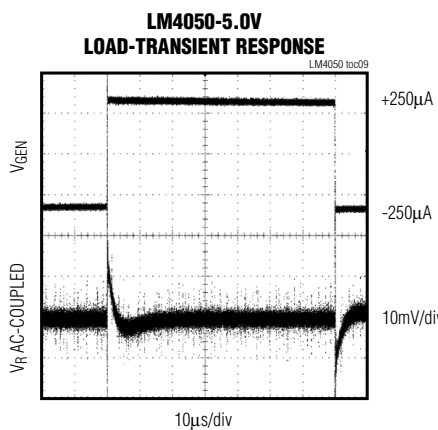

$I_{SHUNT} = 1\text{mA} \pm 250\mu\text{A}$   
 $R_L = 10\text{k}\Omega$ , SEE FIGURE 1.

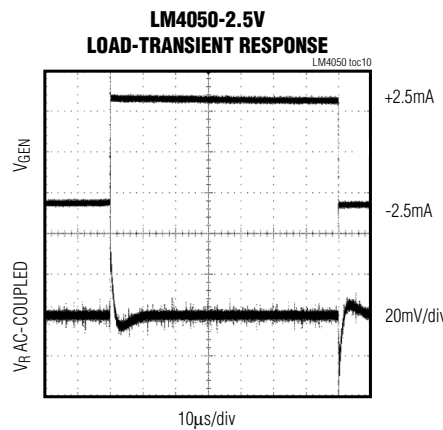

$I_{SHUNT} = 10\text{mA} \pm 2.5\text{mA}$   
 $R_L = 1\text{k}\Omega$ , SEE FIGURE 1.

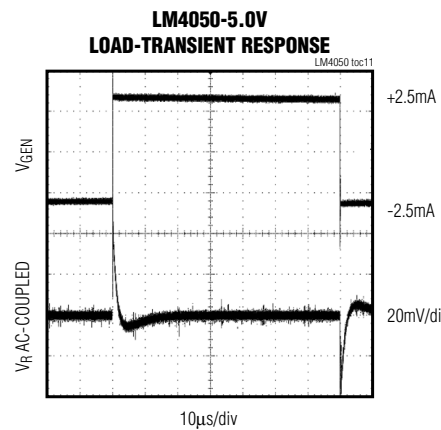

$I_{SHUNT} = 10\text{mA} \pm 2.5\text{mA}$   
 $R_L = 1\text{k}\Omega$ , SEE FIGURE 1.

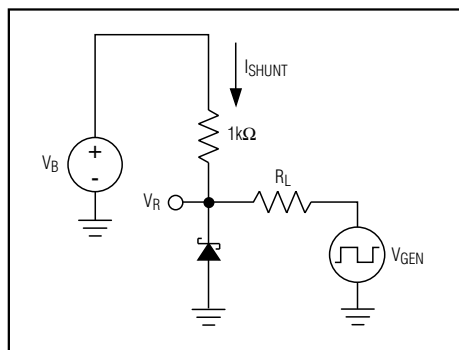
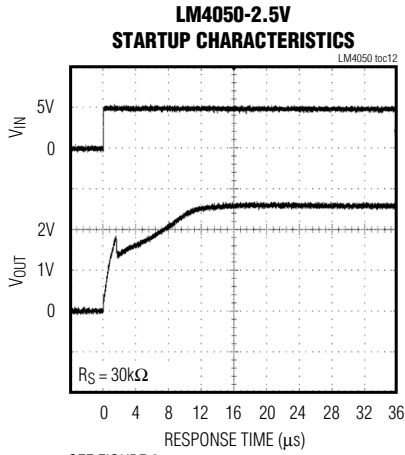

Figure 1. Load-Transient Test Circuit

# 50ppm/°C Precision Micropower Shunt Voltage References with Multiple Reverse Breakdown Voltages

## Typical Operating Characteristics (continued)

( $I_R = 100\mu\text{A}$ , SC70-3 package,  $T_A = +25^\circ\text{C}$ , unless otherwise noted.)



SEE FIGURE 2.

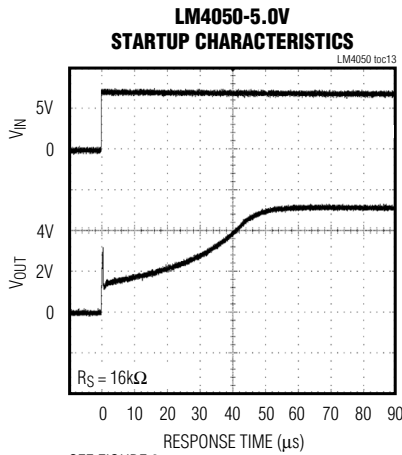

SEE FIGURE 2.

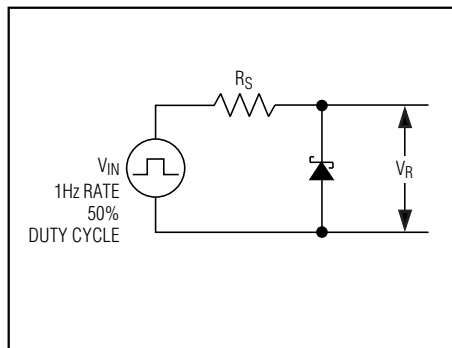
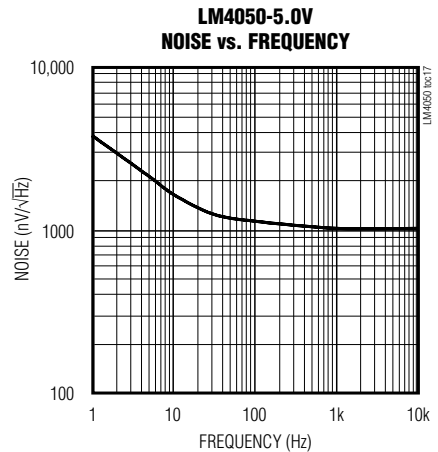
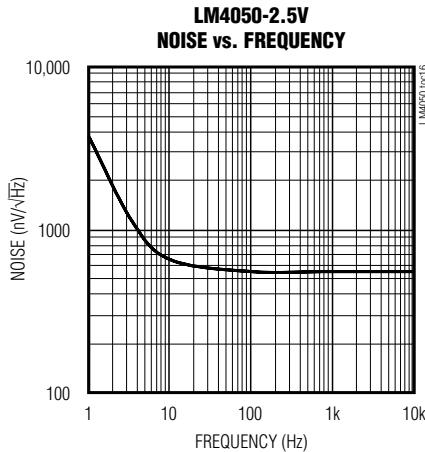
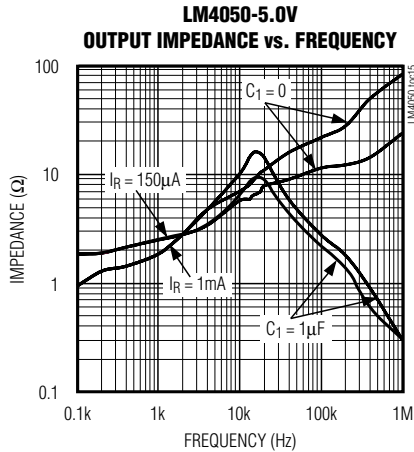
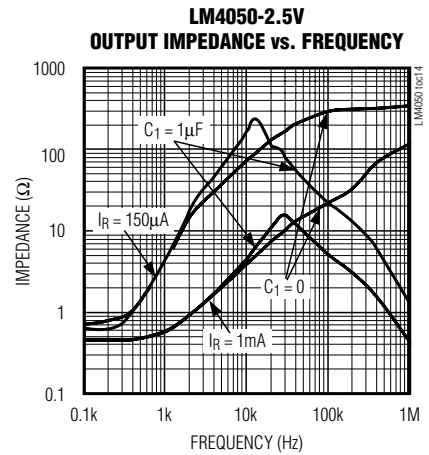

Figure 2. Startup Characteristics Test Circuit

# 50ppm/°C Precision Micropower Shunt Voltage References with Multiple Reverse Breakdown Voltages

LM4050/LM4051

## Pin Description

PIN	NAME	FUNCTION
1	+	Positive Terminal of the Shunt Reference
2	-	Negative Terminal of the Shunt Reference
3	N.C.	No connection. Leave this pin unconnected or connected to pin 2.

## Detailed Description

The LM4050/LM4051 shunt references use the bandgap principle to produce a stable, accurate voltage. The device behaves similarly to an ideal zener diode; a fixed voltage is maintained across its output terminals when biased with 60µA to 15mA of reverse current. The LM4050/LM4051 clamps to a voltage of one diode drop below ground when biased with forward currents up to 10mA.

Figure 3 shows a typical operating circuit. The LM4050/LM4051 are ideal for providing stable references from a high-voltage power supply.

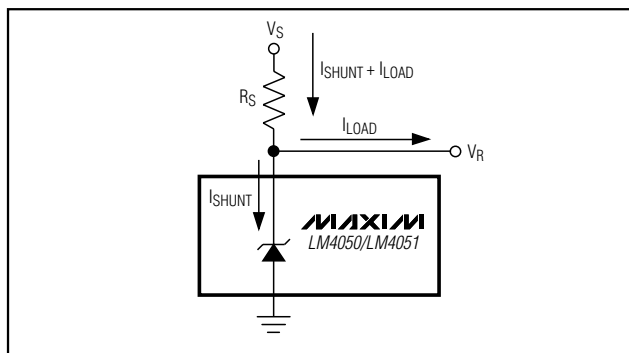

Figure 3. Typical Operating Circuit

## Applications Information

The LM4050/LM4051s' internal pass transistors are used to maintain a constant output voltage ( $V_{SHUNT}$ ) by sinking the necessary amount of current across a source resistor. The source resistance ( $R_S$ ) is determined from the load current ( $I_{LOAD}$ ) range, supply voltage ( $V_S$ ) variations,  $V_{SHUNT}$ , and desired quiescent current.

Choose the value of  $R_S$  when  $V_S$  is at a minimum and  $I_{LOAD}$  is at a maximum. Maintain a minimum  $I_{SHUNT}$  of 60µA at all times. The  $R_S$  value should be large enough to keep  $I_{SHUNT}$  less than 15mA for proper regulation when  $V_S$  is maximum and  $I_{LOAD}$  is at a minimum. To prevent damage to the device,  $I_{SHUNT}$  should never exceed 20mA.

Therefore, the value of  $R_S$  is bounded by the following equation:

$$\frac{[V_S(\text{MIN}) - V_R]}{[60\mu\text{A} + I_{LOAD}(\text{MAX})]} > R_S > \frac{[V_S(\text{MAX}) - V_R]}{[20\text{mA} + I_{LOAD}(\text{MIN})]}$$

Choosing a larger resistance minimizes the total power dissipation in the circuit by reducing the shunt current ( $P_{D(\text{TOTAL})} = V_S \times I_{SHUNT}$ ). Provide a safety margin to incorporate the worst-case tolerance of the resistor used. Ensure that the resistor's power rating is adequate, using the following general power equation:

$$P_{DR} = I_{SHUNT} \times (V_S(\text{MAX}) - V_{SHUNT})$$

## Output Capacitance

The LM4050/LM4051 do not require external capacitors for frequency stability and are stable for any output capacitance.

## Temperature Performance

The LM4050/LM4051 typically exhibit output voltage temperature coefficients within  $\pm 15\text{ppm}/^\circ\text{C}$ . The polarity of the temperature coefficients may be different from one device to another; some may have positive coefficients, and others may have negative coefficients.

## High Temperature Operation

The maximum junction temperature of the LM4050/LM4051 is  $+150^\circ\text{C}$ . The maximum operating temperature for the LM4050/LM4051\_ E\_ is  $+125^\circ\text{C}$ . At a maximum load current of 15mA and a maximum output voltage of 5V, the parts dissipate 75mW of power. The power dissipation limits of the 3-pin SC70 call for a derating value of  $2.17\text{mW}/^\circ\text{C}$  above  $+70^\circ\text{C}$  and thus for 75mW of power dissipation, the parts self-heat to  $35.56^\circ\text{C}$  above ambient temperature. If the ambient temperature is  $+125^\circ\text{C}$ , the parts operate at  $159.56^\circ\text{C}$ , thereby exceeding the maximum junction temperature value of  $+150^\circ\text{C}$ . For high-temperature operation, care must be taken to ensure the combination of ambient temperature, output power dissipation, and package thermal resistance does not conspire to raise the device temperature beyond that listed in the *Absolute Maximum Ratings*. Either reduce the output load current or the ambient temperature to keep the part within the limits.

## Chip Information

TRANSISTOR COUNT: 60

PROCESS: BiCMOS

# 50ppm/°C Precision Micropower Shunt Voltage References with Multiple Reverse Breakdown Voltages

## Ordering Information

LM4050/LM4051

PART	OUTPUT VOLTAGE (V)	INITIAL ACCURACY (%)	TEMPCO (ppm/°C)	TEMP RANGE	PIN-PACKAGE	TOP MARK
LM4050AIM3-2.1-T	2.048	0.1	50	-40°C to +125°C	3 SOT23-3	FZLN
LM4050AIX3-2.1-T	2.048	0.1	50	-40°C to +125°C	3 SC70-3	AJX
LM4050BIM3-2.1-T	2.048	0.2	50	-40°C to +125°C	3 SOT23-3	FZLO
LM4050BIX3-2.1-T	2.048	0.2	50	-40°C to +125°C	3 SC70-3	AJY
LM4050CIM3-2.1-T	2.048	0.5	50	-40°C to +125°C	3 SOT23-3	FZLP
LM4050CIX3-2.1-T	2.048	0.5	50	-40°C to +125°C	3 SC70-3	AJZ
LM4050AIM3-2.5-T	2.500	0.1	50	-40°C to +125°C	3 SOT23-3	FZLR
LM4050AIX3-2.5-T	2.500	0.1	50	-40°C to +125°C	3 SC70-3	AKB
LM4050BIM3-2.5-T	2.500	0.2	50	-40°C to +125°C	3 SOT23-3	FZLS
LM4050BIX3-2.5-T	2.500	0.2	50	-40°C to +125°C	3 SC70-3	AKC
LM4050CIM3-2.5-T	2.500	0.5	50	-40°C to +125°C	3 SOT23-3	FZLJ
LM4050CIX3-2.5-T	2.500	0.5	50	-40°C to +125°C	3 SC70-3	AKD
LM4050AIM3-3.0-T	3.000	0.1	50	-40°C to +125°C	3 SOT23-3	FZLV
LM4050AIX3-3.0-T	3.000	0.1	50	-40°C to +125°C	3 SC70-3	AKF
LM4050BIM3-3.0-T	3.000	0.2	50	-40°C to +125°C	3 SOT23-3	FZLW
LM4050BIX3-3.0-T	3.000	0.2	50	-40°C to +125°C	3 SC70-3	AKG
LM4050CIM3-3.0-T	3.000	0.5	50	-40°C to +125°C	3 SOT23-3	FZLX
LM4050CIX3-3.0-T	3.000	0.5	50	-40°C to +125°C	3 SC70-3	AKH
LM4050AEX3-3.3-T	3.300	0.1	50	-40°C to +125°C	3 SC70-3	AOC
LM4050BEX3-3.3-T	3.300	0.2	50	-40°C to +125°C	3 SC70-3	AOD
LM4050CEX3-3.3-T	3.300	0.5	50	-40°C to +125°C	3 SC70-3	AOE
LM4050AIM3-4.1-T	4.096	0.1	50	-40°C to +125°C	3 SOT23-3	FZLZ
LM4050AIX3-4.1-T	4.096	0.1	50	-40°C to +125°C	3 SC70-3	AKJ
LM4050BIM3-4.1-T	4.096	0.2	50	-40°C to +125°C	3 SOT23-3	FZMA
LM4050BIX3-4.1-T	4.096	0.2	50	-40°C to +125°C	3 SC70-3	AKK
LM4050CIM3-4.1-T	4.096	0.5	50	-40°C to +125°C	3 SOT23-3	FZMB
LM4050CIX3-4.1-T	4.096	0.5	50	-40°C to +125°C	3 SC70-3	AKL
LM4050AIM3-5.0-T	5.000	0.1	50	-40°C to +125°C	3 SOT23-3	FZMD
LM4050AIX3-5.0-T	5.000	0.1	50	-40°C to +125°C	3 SC70-3	AKN
LM4050BIM3-5.0-T	5.000	0.2	50	-40°C to +125°C	3 SOT23-3	FZME
LM4050BIX3-5.0-T	5.000	0.2	50	-40°C to +125°C	3 SC70-3	AKO
LM4050CIM3-5.0-T	5.000	0.5	50	-40°C to +125°C	3 SOT23-3	FZOA
LM4050CIX3-5.0-T	5.000	0.5	50	-40°C to +125°C	3 SC70-3	AKP
LM4051AIM3-1.2-T	1.225	0.1	50	-40°C to +125°C	3 SOT23-3	FZLJ
LM4051AIX3-1.2-T	1.225	0.1	50	-40°C to +125°C	3 SC70-3	AJT
LM4051BIM3-1.2-T	1.225	0.2	50	-40°C to +125°C	3 SOT23-3	FZLK
LM4051BIX3-1.2-T	1.225	0.2	50	-40°C to +125°C	3 SC70-3	AJU
LM4051CIM3-1.2-T	1.225	0.5	50	-40°C to +125°C	3 SOT23-3	FZLL
LM4051CIX3-1.2-T	1.225	0.5	50	-40°C to +125°C	3 SC70-3	AJV

# 50ppm/°C Precision Micropower Shunt Voltage References with Multiple Reverse Breakdown Voltages

## Package Information

(The package drawing(s) in this data sheet may not reflect the most current specifications. For the latest package outline information, go to [www.maxim-ic.com/packages](http://www.maxim-ic.com/packages).)

LM4050/LM4051

### NOTES:

1. D&E DO NOT INCLUDE MOLD FLASH.
2. MOLD FLASH OR PROTRUSIONS NOT TO EXCEED .15mm (.006")
3. CONTROLLING DIMENSION: MILLIMETER

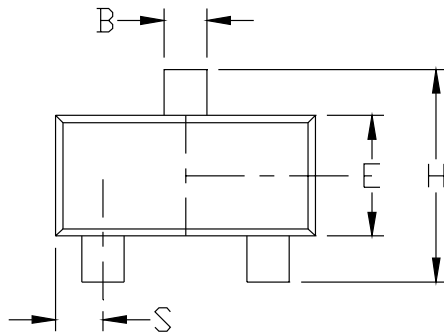

DIM	INCHES		MILLIMETERS	
	MIN	MAX	MIN	MAX
A	0.031	0.047	0.787	1.194
A1	0.001	0.005	0.025	0.127
B	0.014	0.022	0.356	0.559
C	0.0034	0.006	0.086	0.152
D	0.105	0.120	2.667	3.048
E	0.047	0.055	1.194	1.397
e	0.070	0.080	1.778	2.032
H	0.082	0.098	2.083	2.489
L	0.004	0.012	0.102	0.305
S	0.017	0.022	0.432	0.559
$\alpha$	0°	8°	0°	8°

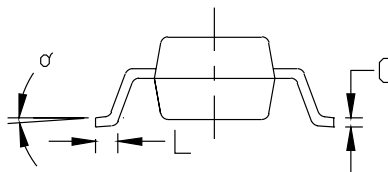
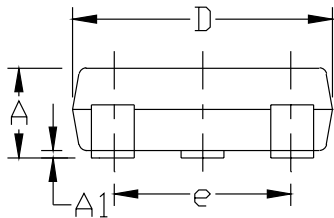

<b>MAXIM</b>			
<small>PROPRIETARY INFORMATION</small>			
<small>TITLE:</small>			
PACKAGE OUTLINE, SOT-23, 3L			
<small>APPROVAL</small>	<small>DOCUMENT CONTROL NO.</small>	<small>REV</small>	<small>1/1</small>
	21-0051	C	

SOT23-3

# 50ppm/°C Precision Micropower Shunt Voltage References with Multiple Reverse Breakdown Voltages

## Package Information (continued)

(The package drawing(s) in this data sheet may not reflect the most current specifications. For the latest package outline information, go to [www.maxim-ic.com/packages](http://www.maxim-ic.com/packages).)

SYMBOL	MIN	MAX
e	0.65	BSC
D	1.80	2.20
b	0.25	0.40
E	1.15	1.35
HE	1.80	2.40
Q1	0.10	0.40
A2	0.80	1.00
A1	0.00	0.10
A	0.80	1.10
c	0.10	0.18
L	0.10	0.30
L1	0.425	TYP.

NOTE:

1. ALL DIMENSIONS ARE IN MILLIMETERS
2. DIMENSIONS ARE INCLUSIVE OF PLATING
3. DIMENSIONS ARE EXCLUSIVE OF MOLD FLASH & METAL BURR
4. ALL SPECIFICATIONS COMPLY TO EIAJ SC70
5. COPLANARITY 4 MILS. MAX.

<b>MAXIM</b>			
<small>PROPRIETARY INFORMATION</small>			
<small>TITLE:</small>			
PACKAGE OUTLINE, SC70, 3L			
<small>APPROVAL</small>	<small>DOCUMENT CONTROL NO.</small>	<small>REV</small>	<small>1/1</small>
	21-0075	B	

SC70, 3L EPS

Maxim cannot assume responsibility for use of any circuitry other than circuitry entirely embodied in a Maxim product. No circuit patent licenses are implied. Maxim reserves the right to change the circuitry and specifications without notice at any time.

14 \_\_\_\_\_ **Maxim Integrated Products, 120 San Gabriel Drive, Sunnyvale, CA 94086 408-737-7600**