



LINEAR INTEGRATED CIRCUITS

GENERAL PURPOSE TRANSISTOR ARRAY

The TBA 331 is an array of 5 monolithic NPN transistors in a 14-lead dual in-line plastic package. Two transistors are internally connected to form a differential amplifier. The transistors of the TBA 331 are well suited to low noise general purpose and to a wide variety of applications in low power systems in the DC through VHF range. They may be used as discrete components in conventional circuits; in addition, they provide the very significant inherent integrated circuit advantages of close electrical and thermal matching.

ABSOLUTE MAXIMUM RATINGS

		Each transistor	Total package
V_{CBO}	Collector-base voltage ($I_E = 0$)	20	- V
V_{CEO}	Collector-emitter voltage ($I_B = 0$)	15	- V
V_{CSS} *	Collector-substrate voltage	20	- V
V_{EBO}	Emitter-base voltage ($I_C = 0$)	5	- V
I_C	Collector current	50	- mA
P_{tot}	Total power dissipation at $T_{amb} \leq 55^\circ C$	300	750 mW
T_{stg}, T_j	Storage and junction temperature	-40 to 150	$^\circ C$
T_{op}	Operating temperature	0 to 85	$^\circ C$

* The collector of each transistor of the TBA 331 is isolated from the substrate by an integrated diode. The substrate (pin 13) must be connected to the most negative point in the external circuit to maintain isolation between transistors and to provide for normal transistor action.

ORDERING NUMBER: TBA 331

MECHANICAL DATA

Dimensions in mm

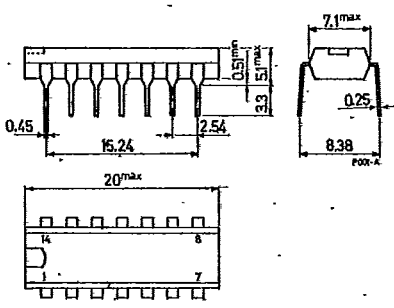

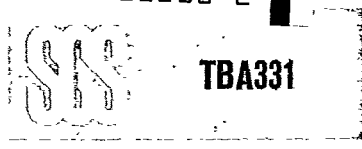

SCHEMATIC DIAGRAM

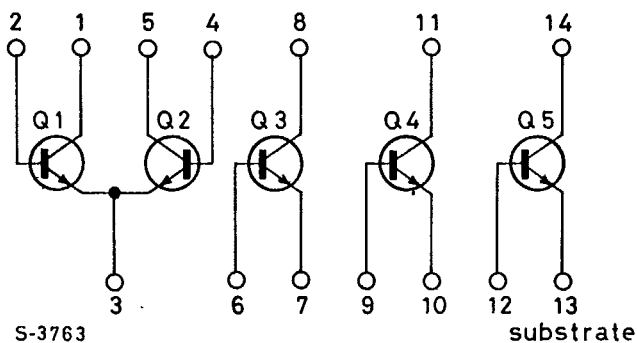

THERMAL DATA

		each	Total
$R_{th J-amb}$	Thermal resistance junction-ambient	max	315° C/W
			126° C/W

ELECTRICAL CHARACTERISTICS ($T_{amb} = 25^{\circ}C$ unless otherwise specified)

Parameter	Test conditions	Min.	Typ.	Max.	Unit
I_{CBO} Collector cutoff current ($I_E = 0$)	$V_{CB} = 10 V$		0.002	40	nA
I_{CEO} Collector cutoff current ($I_B = 0$)	$V_{CE} = 10 V$		see curve	0.5	μA
$ I_{B1} - I_{B2} $ Input offset current	$I_C = 1 mA$ $V_{CE} = 3 V$		0.3	2	μA



TBA331

ELECTRICAL CHARACTERISTICS (continued)

Parameter	Test conditions	Min.	Typ.	Max.	Unit	
V_{CBO}	Collector-base voltage ($I_E = 0$)	$I_C = 10 \mu A$	20	60		V
V_{CEO}	Collector-emitter voltage ($I_E = 0$)	$I_C = 1 \text{ mA}$	15	24		V
V_{CSS}	collector-substrate voltage ($I_{CSS} = 0$)	$I_C = 10 \mu A$	20	60		V
$V_{CE(sat)}$	Collector-emitter saturation voltage	$I_B = 1 \text{ mA}$ $I_C = 10 \text{ mA}$		0.23		V
V_{EBO}	Emitter-base voltage ($I_C = 0$)	$I_E = 10 \mu A$	5	7		V
V_{BE}	Base-emitter voltage	$I_E = 1 \text{ mA}$ $V_{CE} = 3 \text{ V}$ $I_E = 10 \text{ mA}$ $V_{CE} = 3 \text{ V}$		0.715		V
				0.8		V
$ V_{BE1} - V_{BE2} $	Input offset voltage	$I_C = 1 \text{ mA}$ $V_{CE} = 3 \text{ V}$		0.45	5	mV
$ V_{BE3} - V_{BE4} $	Input offset voltage	$I_C = 1 \text{ mA}$ $V_{CE} = 3 \text{ V}$		0.45	5	mV
$ V_{BE4} - V_{BE5} $	Input offset voltage	$I_C = 1 \text{ mA}$ $V_{CE} = 3 \text{ V}$		0.45	5	mV
$ V_{BE5} - V_{BE4} $	Input offset voltage	$I_C = 1 \text{ mA}$ $V_{CE} = 3 \text{ V}$		0.45	5	mV
$\frac{\Delta V_{BE}}{\Delta T}$	Base-emitter voltage temperature coefficient	$I_C = 1 \text{ mA}$ $V_{CE} = 3 \text{ V}$		-1.9		mV/ $^{\circ}C$
$\frac{ V_{BE1} - V_{BE2} }{\Delta T}$	Input offset voltage temperature coefficient	$I_C = 1 \text{ mA}$ $V_{CE} = 3 \text{ V}$		1.1		$\mu V/^{\circ}C$



ELECTRICAL CHARACTERISTICS (continued)

Parameter	Test conditions	Min.	Typ.	Max.	Unit.
h_{FE} DC current gain	$I_C = 10 \text{ mA}$ $V_{CE} = 3 \text{ V}$		100		—
	$I_C = 1 \text{ mA}$ $V_{CE} = 3 \text{ V}$	40	100		—
	$I_C = 10 \mu\text{A}$ $V_{CE} = 3 \text{ V}$		54		—
f_T Transition frequency	$I_C = 3 \text{ mA}$ $V_{CE} = 3 \text{ V}$	300	550		MHz
NF Noise figure	$I_C = 100 \mu\text{A}$ $V_{CE} = 3 \text{ V}$ $f = 1 \text{ KHz}$ $R_g = 1 \text{ k}\Omega$		3.25		dB
H_{ie} Input impedance	$I_C = 1 \text{ mA}$ $V_{CE} = 3 \text{ V}$ $f = 1 \text{ kHz}$		3.5		$\text{k}\Omega$
h_{fe} Forward current transfer ratio	$I_C = 1 \text{ mA}$ $V_{CE} = 3 \text{ V}$ $f = 1 \text{ kHz}$		110		—
h_{re} Reverse voltage transfer ratio	$I_C = 1 \text{ mA}$ $V_{CE} = 3 \text{ V}$ $f = 1 \text{ kHz}$		1.8×10^{-4}		—
h_{oe} Output admittance	$I_C = 1 \text{ mA}$ $V_{CE} = 3 \text{ V}$ $f = 1 \text{ kHz}$		15.6		μS
Y_{ie} Input admittance	$I_C = 1 \text{ mA}$ $V_{CE} = 3 \text{ V}$ $f = 1 \text{ MHz}$		$0.3 + j0.04$		mS
Y_{fe} Forward transadmittance	$I_C = 1 \text{ mA}$ $V_{CE} = 3 \text{ V}$ $f = 1 \text{ MHz}$		$31 - j1.5$		mS
Y_{re} Reverse transadmittance	$I_C = 1 \text{ mA}$ $V_{CE} = 3 \text{ V}$ $f = 1 \text{ MHz}$		see curve		mS

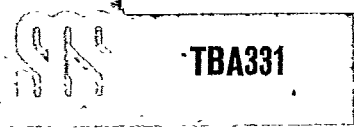

ELECTRICAL CHARACTERISTICS (continued)

Parameter	Test Conditions	Min.	Typ.	Max.	Unit.
V_{ce} Output admittance	$I_C = 1 \text{ mA}$ $V_{CE} = 3 \text{ V}$ $f = 1 \text{ MHz}$		0.001+j0.03		mS
C_{EBO} Emitter-base capacitance	$I_C = 0$ $V_{EB} = 3 \text{ V}$		0.6		pF
C_{CBo} Collector-base capacitance	$I_E = 0$ $V_{CB} = 3 \text{ V}$		0.58		pF
C_{CSS} Collector-substrate capacitance	$I_C = 0$ $V_{CSS} = 3 \text{ V}$		2.8		pF

Fig. 1 - Collector cutoff current vs ambient temperature

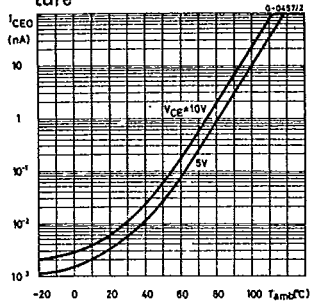

Fig. 2 - DC current gain vs. emitter current.

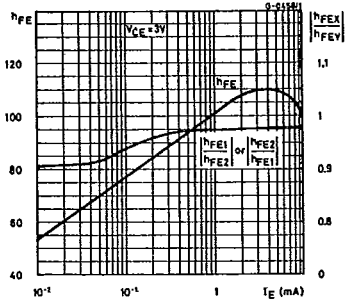

Fig. 3 - Input voltage and input offset voltage vs. emitter current

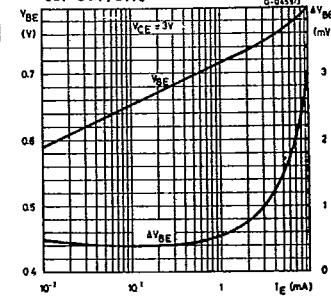

Fig. 4 - Input characteristic for each transistor

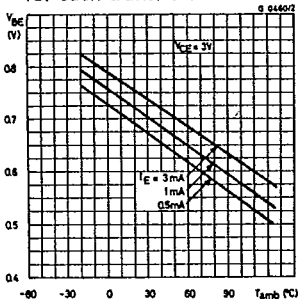

Fig. 5 - Input offset voltage vs. ambient temperature

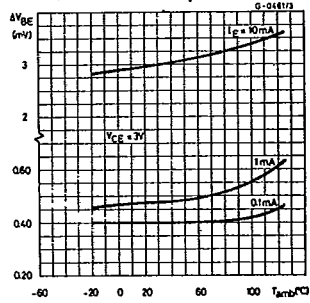

Fig. 6 - Input offset current for matched transistor pair

