

Surface Mounting Chip LED

TSS Type

Conventional Part No.	Global Part No.	Lighting Color
LNJ212R8ARA	LNJ212R8ARA	Red
LNJ312G8LRA	LNJ312G8LRA	Green
LNJ312G8TRA	LNJ312G8TRA	Green
LNJ412K8YRA	LNJ412K8YRA	Amber
LNJ812R8DRA	LNJ812R8DRA	Orange
LNJ812K8SRA	LNJ812K8SRA	Soft Orange

Absolute Maximum Ratings (T_a = 25°C)

Lighting Color	P _D (mW)	I _F (mA)	I _{FP} (mA)*	V _R (V)	T _{opr} (°C)	T _{stg} (°C)
Red	50	20	60	4	-30 ~ +85	-40 ~ +100
Green	30	10	50	4	-30 ~ +85	-40 ~ +100
Green	50	20	60	4	-30 ~ +85	-40 ~ +100
Amber	50	20	60	4	-30 ~ +85	-40 ~ +100
Orange	50	20	60	3	-30 ~ +85	-40 ~ +100
Soft Orange	50	20	60	3	-30 ~ +85	-40 ~ +100

Pulse width 1 msec. The condition of I_{FP} is duty 10%, Pulse width 1 msec

Electro-Optical Characteristics (T_a = 25°C)

Conventional Part No.	Lighting Color	Lens Color	I _O		I _F	V _F		λ _p	Δλ	I _F	I _R	
			Typ	Min		Typ	Max				Max	V _R
LNJ212R8ARA	Red	Red Diffused	6.7	2.2	10	1.72	2.5	655	20	10	100	3
LNJ312G8LRA	Green	Green Diffused	3.0	1.5	5	1.9	2.4	565	30	5	10	4
LNJ312G8TRA	Green	Green Diffused	5.0	1.8	10	2.03	2.6	565	30	10	10	4
LNJ412K8YRA	Amber	Yellow Diffused	1.5	0.6	10	2.0	2.6	59	30	10	10	4
LNJ812R8DRA	Orange	Orange Diffused	1.0	0.4	10	1.93	2.6	630	40	10	10	3
LNJ812K8SRA	Soft Orange	Yellow Diffused	1.0	0.4	10	1.93	2.6	610	40	10	10	3
Unit	—	—	mcd	mcd	mA	V	V	nm	nm	mA	μA	V

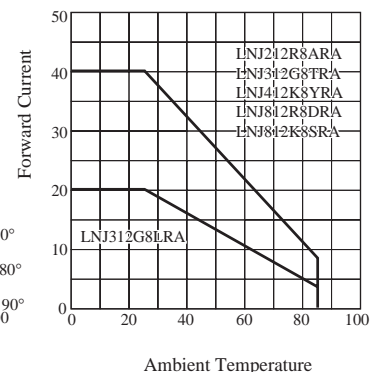
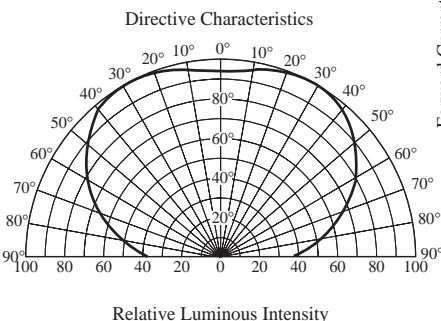
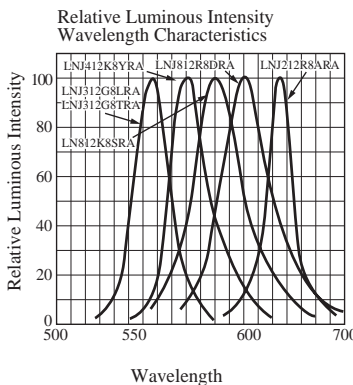
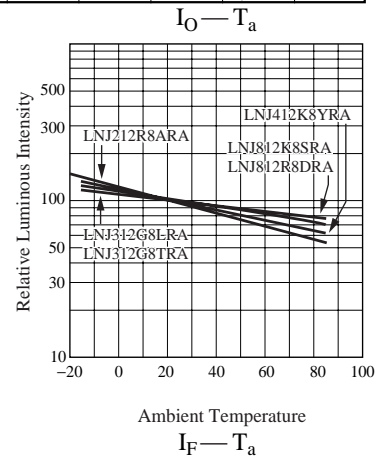
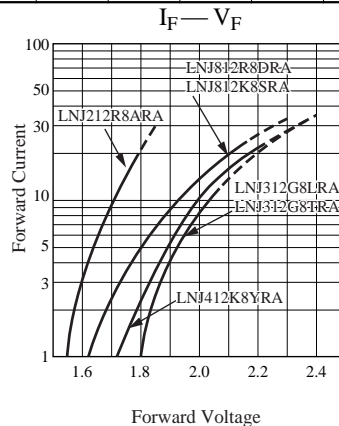
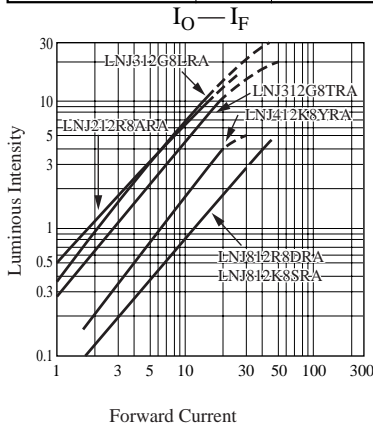
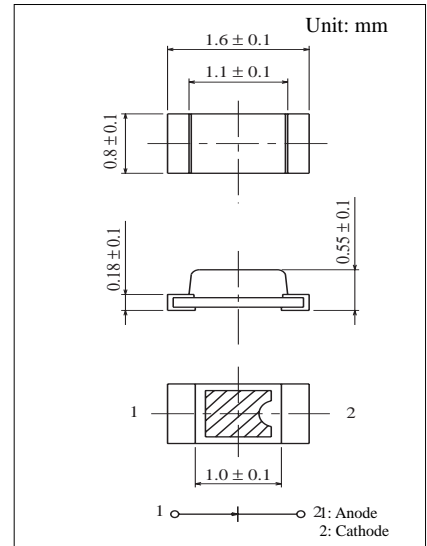

Caution for Safety

 **DANGER**

Gallium arsenide material (GaAs) is used in this product.

Therefore, do not burn, destroy, cut, crush, or chemically decompose the product, since gallium arsenide material in powder or vapor form is harmful to human health.

Observe the relevant laws and regulations when disposing of the products. Do not mix them with ordinary industrial waste or household refuse when disposing of GaAs-containing products.

Request for your special attention and precautions in using the technical information and semiconductors described in this material

- (1) An export permit needs to be obtained from the competent authorities of the Japanese Government if any of the products or technologies described in this material and controlled under the "Foreign Exchange and Foreign Trade Law" is to be exported or taken out of Japan.
- (2) The technical information described in this material is limited to showing representative characteristics and applied circuit examples of the products. It does not constitute the warranting of industrial property, the granting of relative rights, or the granting of any license.
- (3) The products described in this material are intended to be used for standard applications or general electronic equipment (such as office equipment, communications equipment, measuring instruments and household appliances).
Consult our sales staff in advance for information on the following applications:
 - Special applications (such as for airplanes, aerospace, automobiles, traffic control equipment, combustion equipment, life support systems and safety devices) in which exceptional quality and reliability are required, or if the failure or malfunction of the products may directly jeopardize life or harm the human body.
 - Any applications other than the standard applications intended.
- (4) The products and product specifications described in this material are subject to change without notice for reasons of modification and/or improvement. At the final stage of your design, purchasing, or use of the products, therefore, ask for the most up-to-date Product Standards in advance to make sure that the latest specifications satisfy your requirements.
- (5) When designing your equipment, comply with the guaranteed values, in particular those of maximum rating, the range of operating power supply voltage and heat radiation characteristics. Otherwise, we will not be liable for any defect which may arise later in your equipment.
Even when the products are used within the guaranteed values, redundant design is recommended, so that such equipment may not violate relevant laws or regulations because of the function of our products.
- (6) When using products for which dry packing is required, observe the conditions (including shelf life and after-unpacking standby time) agreed upon when specification sheets are individually exchanged.
- (7) No part of this material may be reprinted or reproduced by any means without written permission from our company.

Please read the following notes before using the datasheets

- A. These materials are intended as a reference to assist customers with the selection of Panasonic semiconductor products best suited to their applications.
Due to modification or other reasons, any information contained in this material, such as available product types, technical data, and so on, is subject to change without notice.
Customers are advised to contact our semiconductor sales office and obtain the latest information before starting precise technical research and/or purchasing activities.
- B. Panasonic is endeavoring to continually improve the quality and reliability of these materials but there is always the possibility that further rectifications will be required in the future. Therefore, Panasonic will not assume any liability for any damages arising from any errors etc. that may appear in this material.
- C. These materials are solely intended for a customer's individual use.
Therefore, without the prior written approval of Panasonic, any other use such as reproducing, selling, or distributing this material to a third party, via the Internet or in any other way, is prohibited.