



# LC75341, 75341M

## Single-Chip Volume and Tone Control System

### Preliminary



### Overview

The LC75341 and LC75341M are electronic volume and tone control systems that provide volume, balance, a 2-band equalizer, and input switching functions that can be controlled from serially transferred data.

### Functions

- Volume: 0 dB to  $-79$  dB (in 1-dB steps) and  $-\infty$ , for a total of 81 settings.  
The volume can be controlled independently in the left and right channels to implement a balance function.
- Bass boost: Up to +20 dB in 2-dB steps. Peaking characteristics.
- Treble:  $\pm 10$  dB in 2-dB steps. Shelving characteristics.
- Selector: One of four sets of left/right inputs can be selected.
- Input gain: The input signal can be boosted by from 0 dB to +30 dB in 2-dB steps.

### Features

- On-chip buffer amplifiers minimize the number of external components.
- Fabricated in a silicon gate CMOS process to minimize switching noise from internal switches.
- Built-in analog ground reference voltage generation circuit.
- All controls can be set from serially transferred data. Supports the CCB standard.

### Package Dimensions

unit: mm

#### 3067-DIP24S

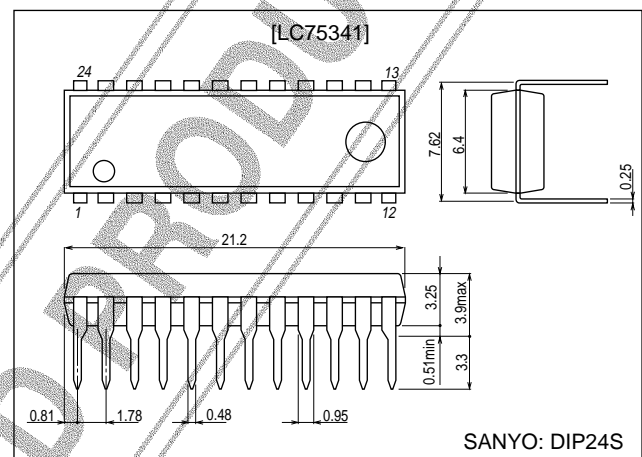

unit: mm

#### 3112-MFP24S

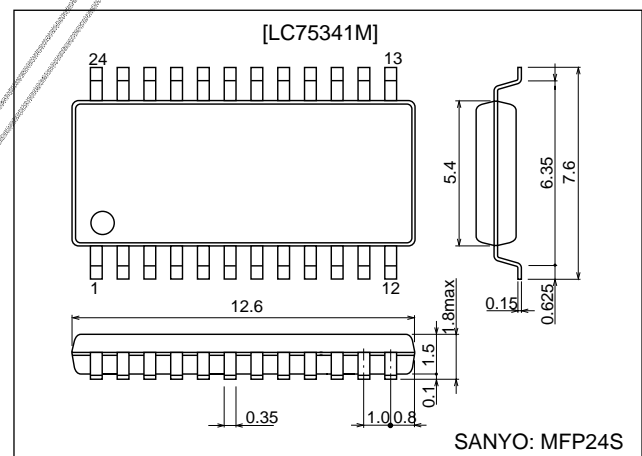

- CCB is a trademark of SANYO ELECTRIC CO., LTD.
- CCB is a SANYO's original bus format and all the bus addresses are controlled by SANYO.

■ Any and all SANYO products described or contained herein do not have specifications that can handle applications that require extremely high levels of reliability, such as life-support systems, aircraft's control systems, or other applications whose failure can be reasonably expected to result in serious physical and/or material damage. Consult with your SANYO representative nearest you before using any SANYO products described or contained herein in such applications.

■ SANYO assumes no responsibility for equipment failures that result from using products at values that exceed, even momentarily, rated values (such as maximum ratings, operating condition ranges, or other parameters) listed in products specifications of any and all SANYO products described or contained herein.

**SANYO Electric Co., Ltd. Semiconductor Company**

TOKYO OFFICE Tokyo Bldg., 1-10, 1 Chome, Ueno, Taito-ku, TOKYO, 110-8534 JAPAN

## LC75341, 75341M

### Specifications

#### Absolute Maximum Ratings at $T_a = 25^\circ\text{C}$ , $V_{SS} = 0\text{ V}$

Parameter	Symbol	Pin	Conditions	Ratings	Unit	
Maximum supply voltage	$V_{DD\text{ max}}$	$V_{DD}$		11	V	
Maximum input voltage	$V_{IN\text{ max}}$	CE, DI, CL, L1 to L4, R1 to R4, LIN, RIN		$V_{SS} - 0.3$ to $V_{DD} + 0.3$	V	
Allowable power dissipation	$P_{dmax}$		$T_a \leq 75^\circ\text{C}$	LC75341	450	mW
			$T_a \leq 75^\circ\text{C}$ with a PCB*	LC75341M	450	
Operating temperature	$T_{opr}$			-30 to +75	$^\circ\text{C}$	
Storage temperature	$T_{stg}$			-40 to +125	$^\circ\text{C}$	

Note: \* Printed circuit board size:  $76.1 \times 114.3 \times 1.6$  mm, printed circuit board material: glass/epoxy resin

#### Allowable Operating Ranges at $T_a = -30$ to $+75^\circ\text{C}$ , $V_{SS} = 0\text{ V}$

Parameter	Symbol	Pin	Conditions	Ratings			Unit
				min	typ	max	
Supply voltage	$V_{DD}$	$V_{DD}$		5.0		10	V
High-level input voltage	$V_{IH}$	CL, DI, CE		2.7		10	V
Low-level input voltage	$V_{IL}$	CL, DI, CE	$7.5 \leq V_{DD} \leq 10.0$	$V_{SS}$		1.0	V
			$5.0 \leq V_{DD} < 7.5$	$V_{SS}$		0.8	
Input voltage amplitude	$V_{IN}$	CE, DI, CL, L1 to L4, R1 to R4, LIN, RIN		$V_{SS}$		$V_{DD}$	Vp-p
Input pulse width	$t_{\text{PW}}$	CL		1			$\mu\text{s}$
Setup time	$t_{\text{setup}}$	CL, DI, CE		1			$\mu\text{s}$
Hold time	$t_{\text{hold}}$	CL, DI, CE		1			$\mu\text{s}$
Operating frequency	$f_{\text{opg}}$	CL				500	kHz

#### Electrical Characteristics at $T_a = 25^\circ\text{C}$ , $V_{DD} = 9\text{ V}$ , $V_{SS} = 0\text{ V}$

##### Input Block

Parameter	Symbol	Pin	Conditions	Ratings			Unit
				min	typ	max	
Maximum input gain	$G_{in\text{ max}}$				+30		dB
Step resolution	$G_{step}$				+2		dB
Input resistance	$R_{in}$	L1, L2, L3, L4, R1, R2, R3, R4			50		k $\Omega$
Clipping level	$V_{cl}$	LSEL0, RSEL0	THD = 1.0%, $f = 1\text{ kHz}$		2.90		Vrms
Output load resistance	$R_l$	LSEL0, RSEL0		10			k $\Omega$

##### Volume Control Block

Parameter	Symbol	Pin	Conditions	Ratings			Unit
				min	typ	max	
Input resistance	$R_{in}$	$L_{IN}, R_{IN}$			50		k $\Omega$

##### Bass Band Equalizer Control Block

Parameter	Symbol	Pin	Conditions	Ratings			Unit
				min	typ	max	
Control range	$G_{eq}$		max.boost	+18	+20	+22	dB
Step resolution	$E_{step}$			1	2	3	dB
Internal feedback resistance	$R_{feed}$				66.6		k $\Omega$

##### Treble Band Equalizer Control Block

Parameter	Symbol	Pin	Conditions	Ratings			Unit
				min	typ	max	
Control range	$G_{eq}$		max.boost/cut	$\pm 8$	$\pm 10$	$\pm 12$	dB
Step resolution	$E_{step}$			1	2	3	dB
Internal feedback resistance	$R_{feed}$				51.7		k $\Omega$

## LC75341, 75341M

### Overall Characteristics

Parameter	Symbol	Conditions	Ratings			Unit
			min	typ	max	
Total harmonic distortion	THD	$V_{IN} = 1 \text{ Vrms}$ , $f = 1 \text{ kHz}$ , all flat overall			0.01	%
Crosstalk	CT	$V_{IN} = 1 \text{ Vrms}$ , $f = 1 \text{ kHz}$ , $R_g = 1 \text{ k}\Omega$ , all flat overall	80			dB
Output noise voltage	$V_N$	All flat overall, 80 kHz, L.P.F		9.3		$\mu\text{V}$
Maximum attenuation	Vomin	All flat overall, $f = 1 \text{ kHz}$		-90		dB
Current drain	$I_{DD}$	$V_{DD} - V_{SS} = +10 \text{ V}$		37		mA
High-level input current	$I_{IH}$	CL, DI, CE: $V_{IN} = 10 \text{ V}$			10	$\mu\text{A}$
Low-level input current	$I_{IL}$	CL, DI, CE: $V_{IN} = 0 \text{ V}$	-10			$\mu\text{A}$

### Pin Assignment

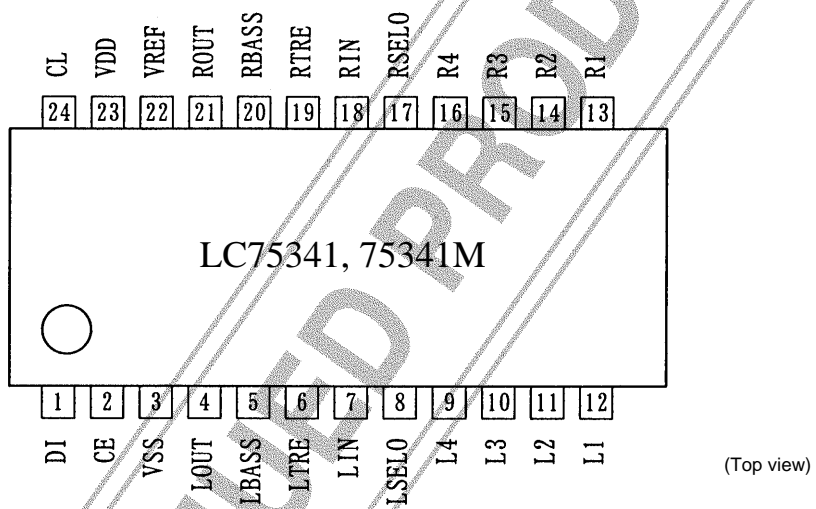

Equivalent Circuit

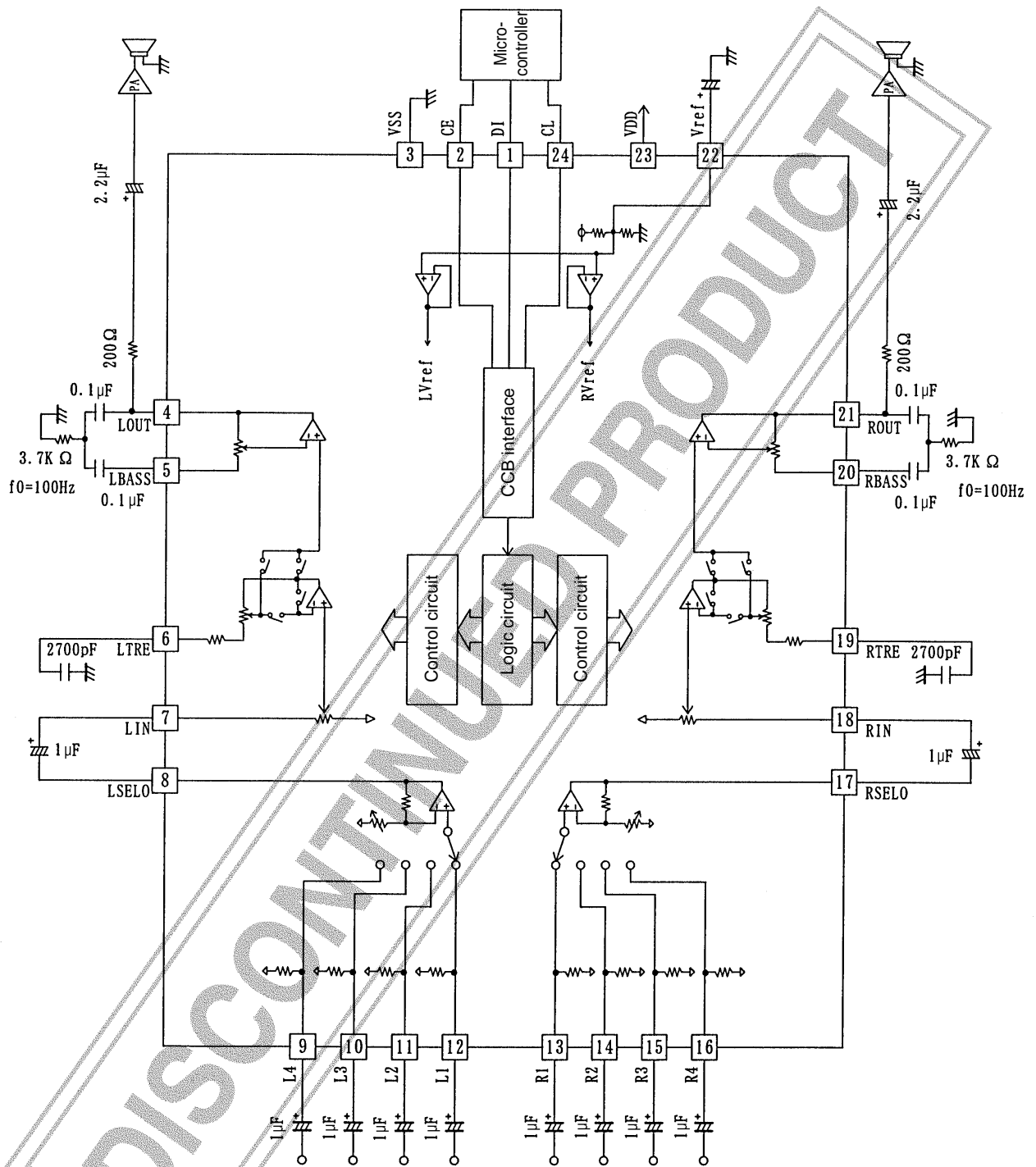

**Control System Timing and Data Format**

Applications control the LC75341 and LC75341M by applying the stipulated serial data to the CL, DI, and CE pins. This data consists of a total of 40 bits, of which 8 bits are the address and 32 bits are the data itself.

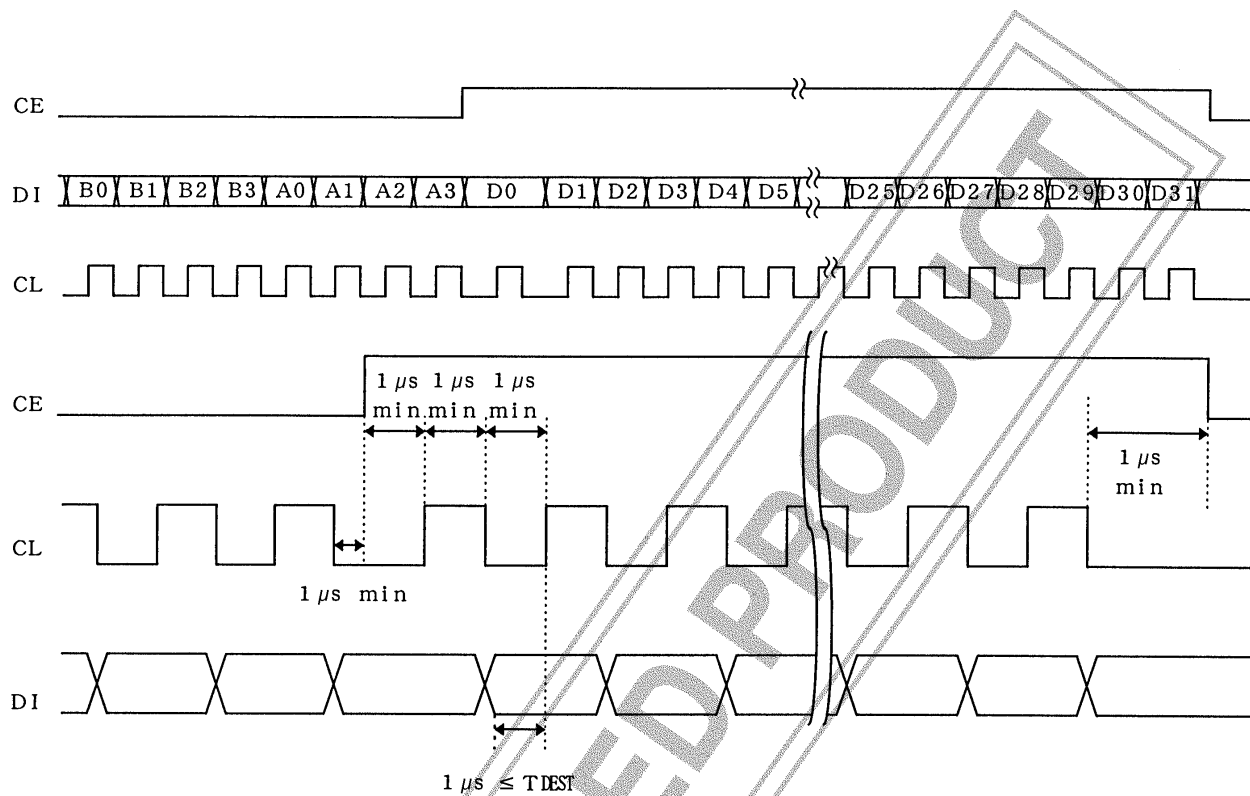

• Address code (B0 to A3)

The LC75341 and LC75341M have an 8-bit address code, and can be used together with other ICs that support the Sanyo CCB serial bus format.

Address code (LSB)	B0	B1	B2	B3	A0	A1	A2	A3	(82HEX)
	0	1	0	0	0	0	0	1	

• Control code allocation

Input switching control (L1, L2, L3, L4, R1, R2, R3, R4)

D0	D1	D2	D3	Operation
0	0	0	0	L1 (R1) ON
1	0	0	0	L2 (R2) ON
0	1	0	0	L3 (R3) ON
1	1	0	0	L4 (R4) ON
0	0	1	0	All switches off
1	0	1	0	All switches off
0	1	1	0	All switches off
1	1	1	0	All switches off

LC75341, 75341M

Input Gain Control

D4	D5	D6	D7	Operation
0	0	0	0	0 dB
1	0	0	0	+2 dB
0	1	0	0	+4 dB
1	1	0	0	+6 dB
0	0	1	0	+8 dB
1	0	1	0	+10 dB
0	1	1	0	+12 dB
1	1	1	0	+14 dB
0	0	0	1	+16 dB
1	0	0	1	+18 dB
0	1	0	1	+20 dB
1	1	0	1	+22 dB
0	0	1	1	+24 dB
1	0	1	1	+26 dB
0	1	1	1	+28 dB
1	1	1	1	+30 dB

DISCONTINUED PRODUCT

LC75341, 75341M

Volume Control

D8	D9	D10	D11	D12	D13	D14	D15	Operation
0	0	0	0	0	0	0	0	0 dB
1	0	0	0	0	0	0	0	-1 dB
0	1	0	0	0	0	0	0	-2 dB
1	1	0	0	0	0	0	0	-3 dB
0	0	1	0	0	0	0	0	-4 dB
1	0	1	0	0	0	0	0	-5 dB
0	1	1	0	0	0	0	0	-6 dB
1	1	1	0	0	0	0	0	-7 dB
0	0	0	1	0	0	0	0	-8 dB
1	0	0	1	0	0	0	0	-9 dB
0	1	0	1	0	0	0	0	-10 dB
1	1	0	1	0	0	0	0	-11 dB
0	0	1	1	0	0	0	0	-12 dB
1	0	1	1	0	0	0	0	-13 dB
0	1	1	1	0	0	0	0	-14 dB
1	1	1	1	0	0	0	0	-15 dB
0	0	0	0	1	0	0	0	-16 dB
1	0	0	0	1	0	0	0	-17 dB
0	1	0	0	1	0	0	0	-18 dB
1	1	0	0	1	0	0	0	-19 dB
0	0	1	0	1	0	0	0	-20 dB
1	0	1	0	1	0	0	0	-21 dB
0	1	1	0	1	0	0	0	-22 dB
1	1	1	0	1	0	0	0	-23 dB
0	0	0	1	1	0	0	0	-24 dB
1	0	0	1	1	0	0	0	-25 dB
0	1	0	1	1	0	0	0	-26 dB
1	1	0	1	1	0	0	0	-27 dB
0	0	1	1	1	0	0	0	-28 dB
1	0	1	1	1	0	0	0	-29 dB
0	1	1	1	1	0	0	0	-30 dB
1	1	1	1	1	0	0	0	-31 dB
0	0	0	0	0	1	0	0	-32 dB
1	0	0	0	0	1	0	0	-33 dB
0	1	0	0	0	1	0	0	-34 dB
1	1	0	0	0	1	0	0	-35 dB
0	0	1	0	0	1	0	0	-36 dB
1	0	1	0	0	1	0	0	-37 dB
0	1	1	0	0	1	0	0	-38 dB
1	1	1	0	0	1	0	0	-39 dB
0	0	0	1	0	1	0	0	-40 dB
1	0	0	1	0	1	0	0	-41 dB
0	1	0	1	0	1	0	0	-42 dB
1	1	0	1	0	1	0	0	-43 dB
0	0	1	1	0	1	0	0	-44 dB
1	0	1	1	0	1	0	0	-45 dB
0	1	1	1	0	1	0	0	-46 dB
1	1	1	1	0	1	0	0	-47 dB
0	0	0	0	1	1	0	0	-48 dB
1	0	0	0	1	1	0	0	-49 dB
0	1	0	0	1	1	0	0	-50 dB

DISCONTINUED PRODUCT

LC75341, 75341M

Volume Control

D8	D9	D10	D11	D12	D13	D14	D15	Operation
1	1	0	0	1	1	0	0	-51 dB
0	0	1	0	1	1	0	0	-52 dB
1	0	1	0	1	1	0	0	-53 dB
0	1	1	0	1	1	0	0	-54 dB
1	1	1	0	1	1	0	0	-55 dB
0	0	0	1	1	1	0	0	-56 dB
1	0	0	1	1	1	0	0	-57 dB
0	1	0	1	1	1	0	0	-58 dB
1	1	0	1	1	1	0	0	-59 dB
0	0	1	1	1	1	0	0	-60 dB
1	0	1	1	1	1	0	0	-61 dB
0	1	1	1	1	1	0	0	-62 dB
1	1	1	1	1	1	0	0	-63 dB
0	0	0	0	0	0	1	0	-64 dB
1	0	0	0	0	0	1	0	-65 dB
0	1	0	0	0	0	1	0	-66 dB
1	1	0	0	0	0	1	0	-67 dB
0	0	1	0	0	0	1	0	-68 dB
1	0	1	0	0	0	1	0	-69 dB
0	1	1	0	0	0	1	0	-70 dB
1	1	1	0	0	0	1	0	-71 dB
0	0	0	1	0	0	1	0	-72 dB
1	0	0	1	0	0	1	0	-73 dB
0	1	0	1	0	0	1	0	-74 dB
1	1	0	1	0	0	1	0	-75 dB
0	0	1	1	0	0	1	0	-76 dB
1	0	1	1	0	0	1	0	-77 dB
0	1	1	1	0	0	1	0	-78 dB
1	1	1	1	0	0	1	0	-79 dB
0	0	0	0	1	0	1	0	-∞ dB

Treble Control

D16	D17	D18	D19	Operation
1	0	1	0	+10 dB
0	0	1	0	+8 dB
1	1	0	0	+6 dB
0	1	0	0	+4 dB
1	0	0	0	+2 dB
0	0	0	0	0 dB
1	0	0	1	-2 dB
0	1	0	1	-4 dB
1	1	0	1	-6 dB
0	0	1	1	-8 dB
1	0	1	1	-10 dB



## LC75341, 75341M

### Bass Control

D20	D21	D22	D23	D24	D25	Operation
0	1	0	1	0	0	+20 dB
1	0	0	1	0	0	+18 dB
0	0	0	1	0	0	+16 dB
1	1	1	0	0	0	+14 dB
0	1	1	0	0	0	+12 dB
1	0	1	0	0	0	+10 dB
0	0	1	0	0	0	+8 dB
1	1	0	0	0	0	+6 dB
0	1	0	0	0	0	+4 dB
1	0	1	0	0	0	+2 dB
0	0	0	0	0	0	0 dB

### Channel Selection

D26	D27	Operation
0	0	
1	0	RCH
0	1	LCH
1	1	Left and right together

### Test Mode

D28	D29	D30	D31	Operation
0	0	0	0	

These bits are used for IC testing and must all be set to 0 during normal operation.

DISCONTINUED PRODUCT

Pin Functions

Pin No.	Pin	Description	Notes
12 11 10 9 13 14 15 16	L1 L2 L3 L4 R1 R2 R3 R4	<ul style="list-style-type: none"> <li>Input signal connections</li> </ul>	
8 17	LSELO RSELO	<ul style="list-style-type: none"> <li>Input selector outputs</li> </ul>	
5 20	LBASS RBASS	<ul style="list-style-type: none"> <li>Connections for the resistors and capacitors that form the bass band filters.</li> </ul>	
4 21	LOUT ROUT	<ul style="list-style-type: none"> <li>These pins are used both as the connections for the resistors and capacitors that form the bass band filters and as the outputs from the bass/treble circuits.</li> </ul>	
6 19	LTRE RTRE	<ul style="list-style-type: none"> <li>Connections for the capacitors that form the treble band filters.</li> </ul>	
7 18	LIN RIN	<ul style="list-style-type: none"> <li>Volume control and equalizer input</li> </ul>	
22	Vref	<ul style="list-style-type: none"> <li>Connection to the <math>0.5 \times V_{DD}</math> voltage generator circuit used as the analog signal ground.</li> <li>Applications must connect a capacitor of about 10 <math>\mu\text{F}</math> between this pin and <math>V_{SS}</math> to exclude power supply ripple.</li> </ul>	

Continued on next page.

## LC75341, 75341M

Continued from preceding page.

Pin No.	Pin	Description	Notes
3	V <sub>SS</sub>	• Ground	
23	V <sub>DD</sub>	• Power supply	
2	CE	• Chip enable Data is written to the internal latch when this pin goes from high to low. The internal analog switches operate at this point. Data transfer is enabled when this pin is high.	
1 24	DI CL	• Serial data and clock inputs used for IC control.	

### Internal Equivalent Circuits

- Selector block equivalent circuit

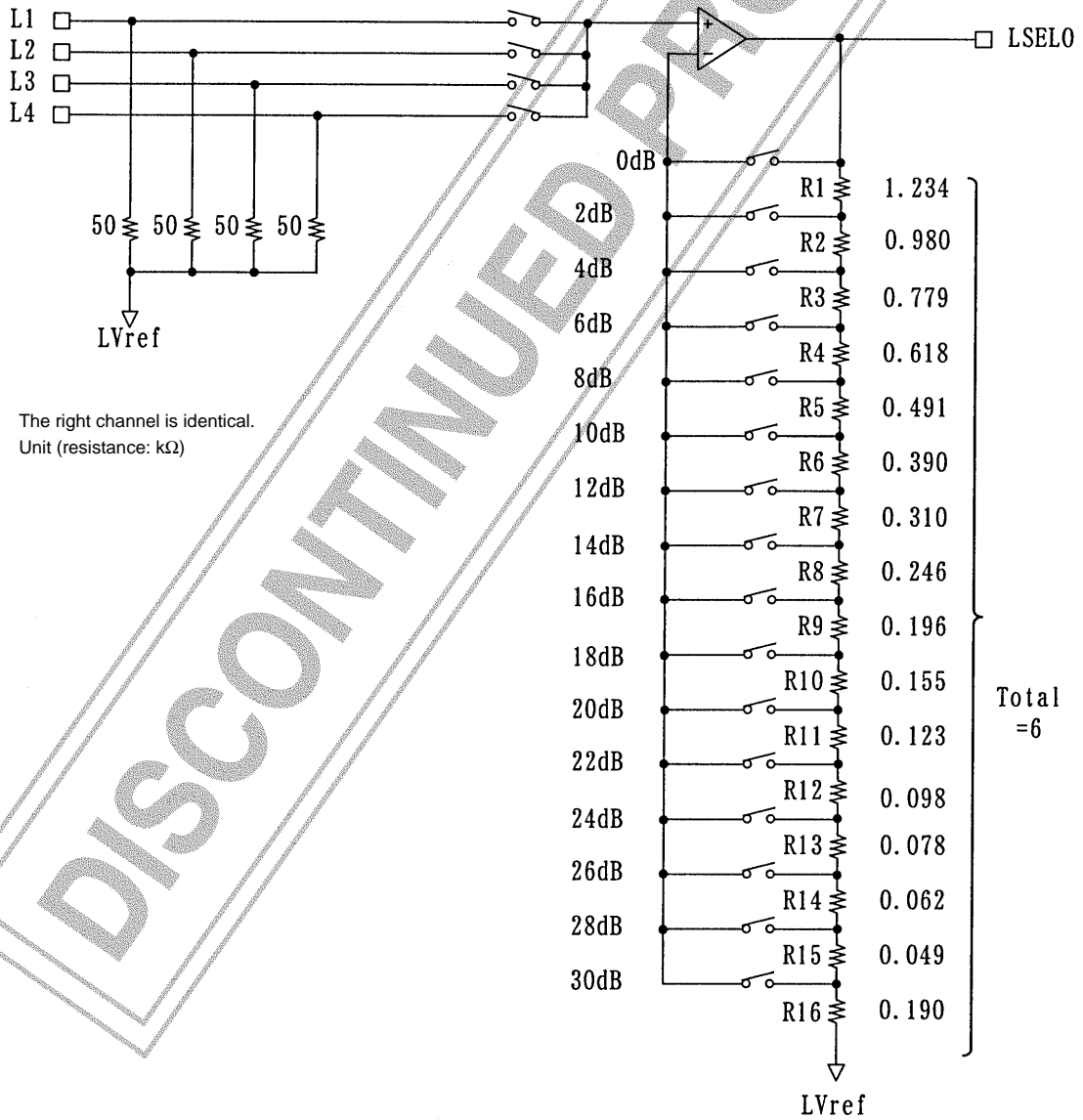

LC75341, 75341M

• Treble and bass band block internal equivalent circuit

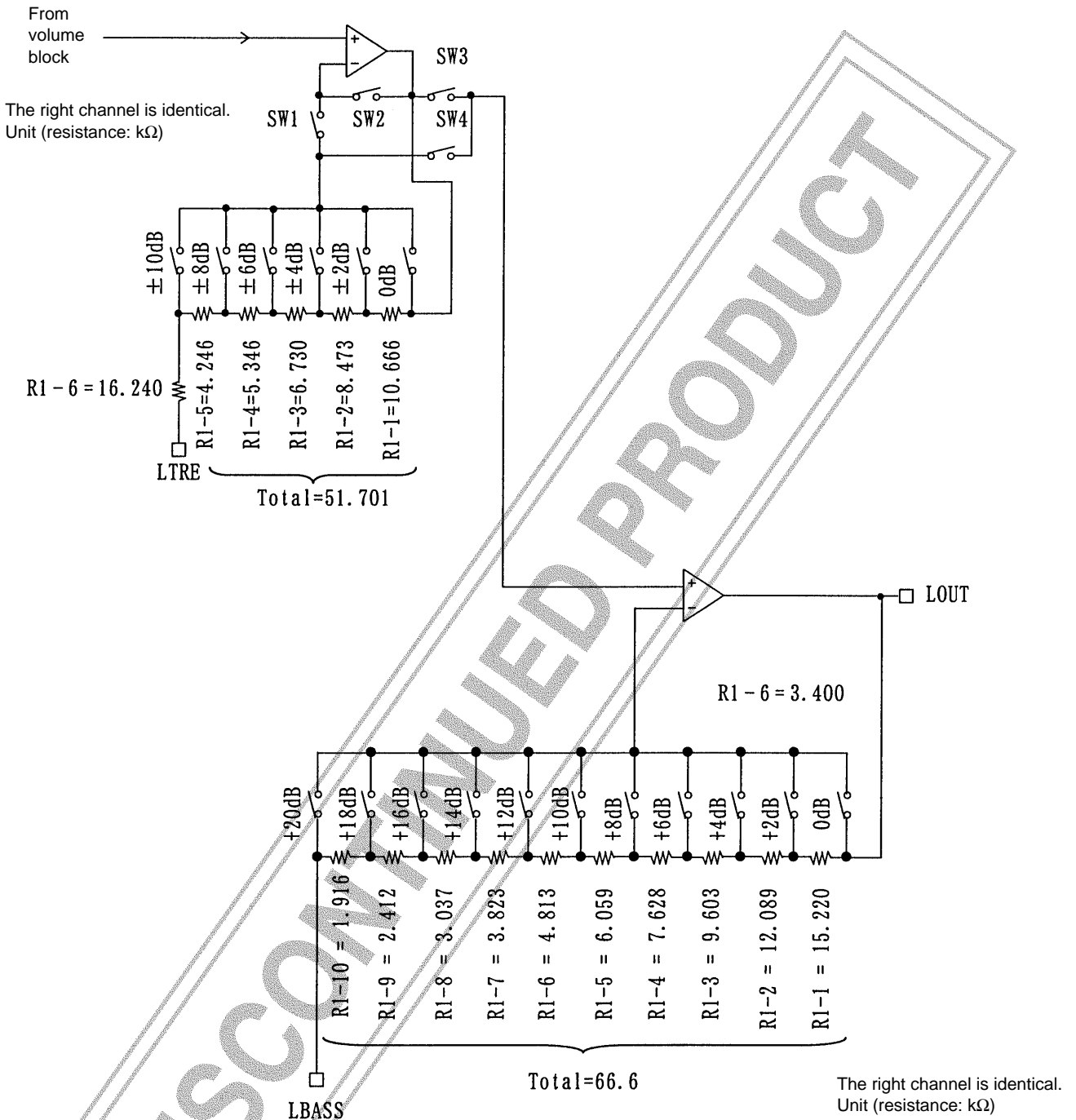

Set switches SW1 and SW3 to the on position for boost, and set switches SW2 and SW4 to the on position for cut. For a flat (0 dB) response, set the 0dB SW, SW2, and SW3 switches on.

# LC75341, 75341M

- Volume block internal equivalent circuit

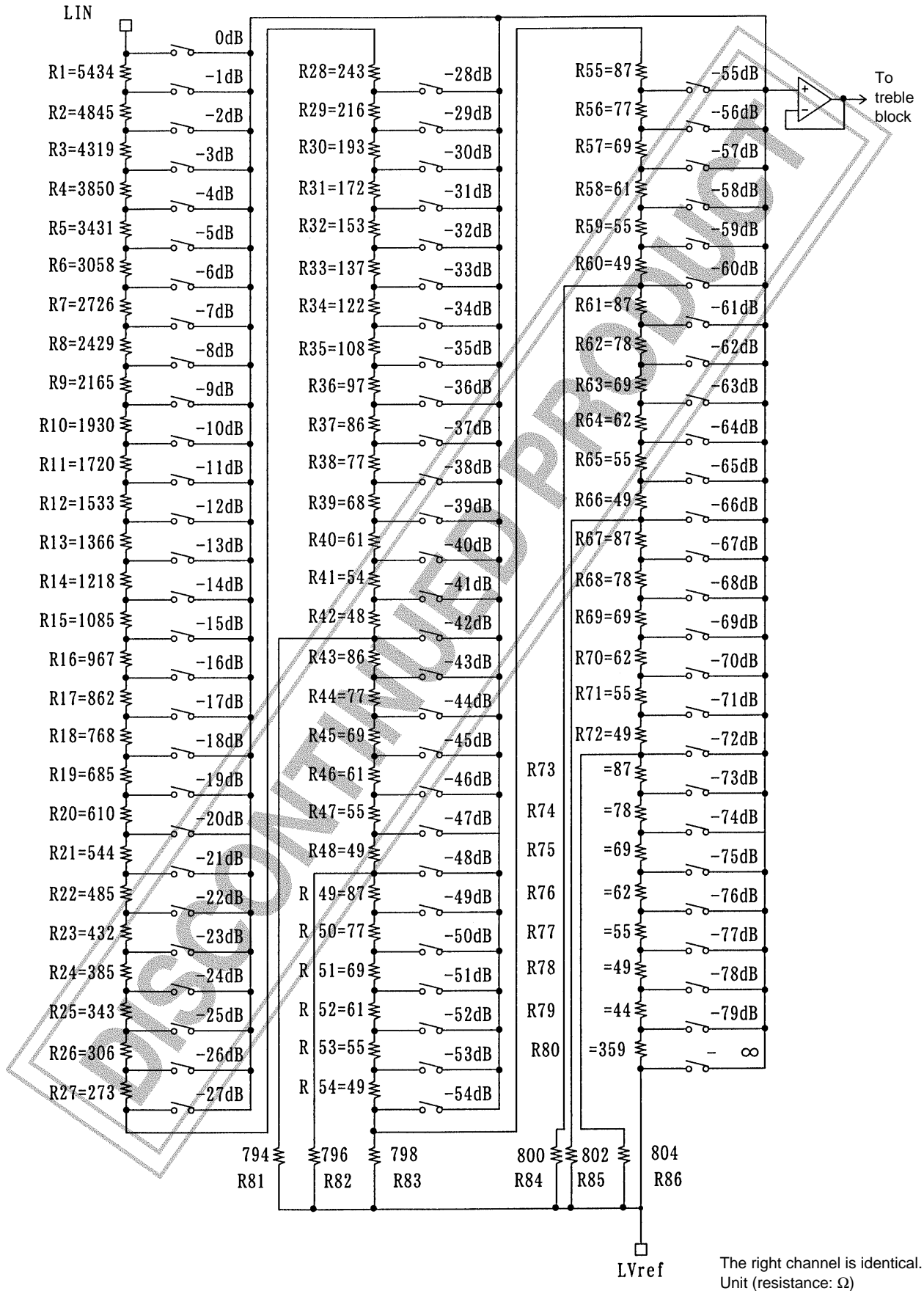

Test Circuits

- Total harmonic distortion

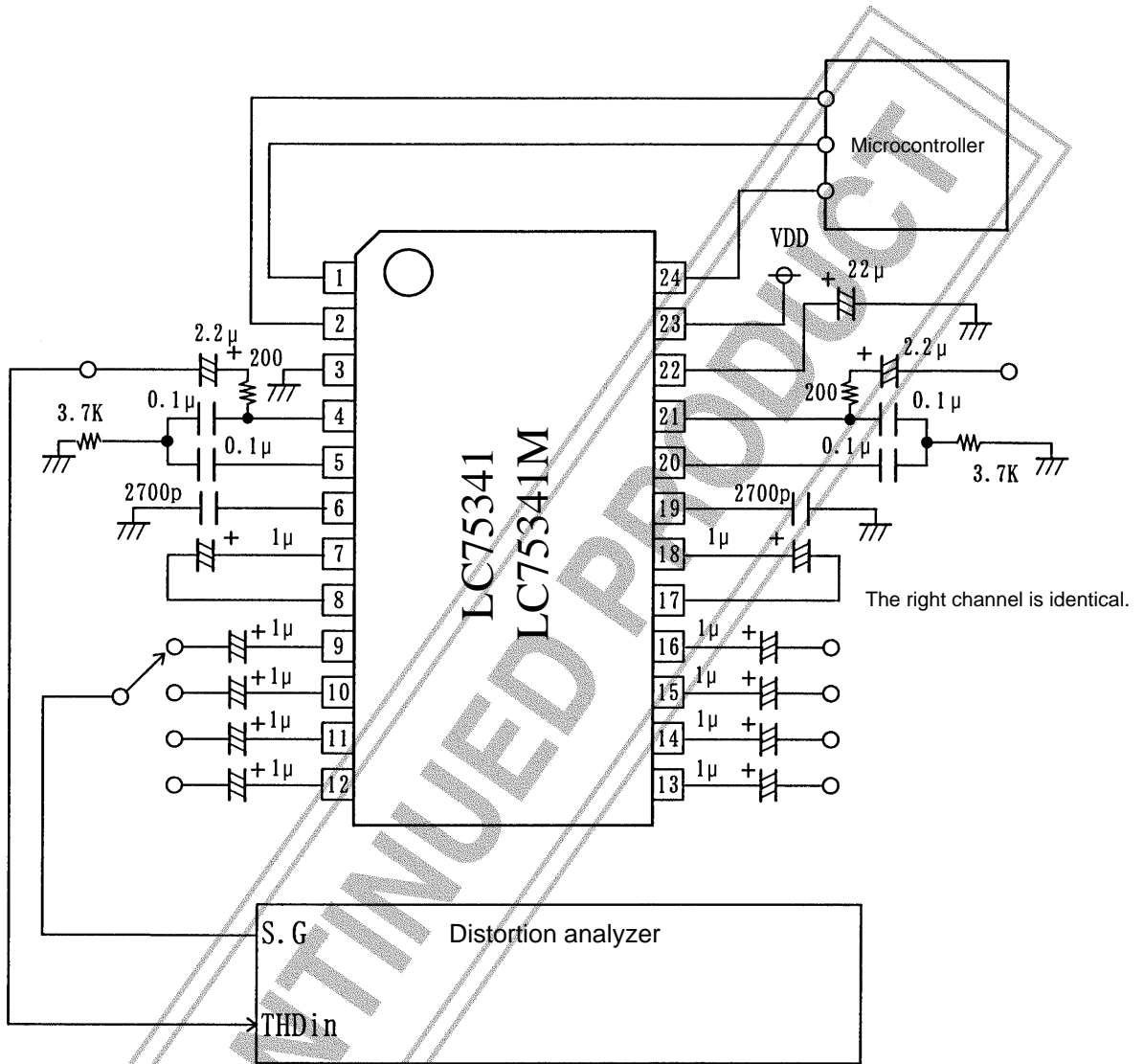

Units (resistance: Ω, capacitance: F)

DISCONTINUED PRODUCT

LC75341, 75341M

- Output noise voltage

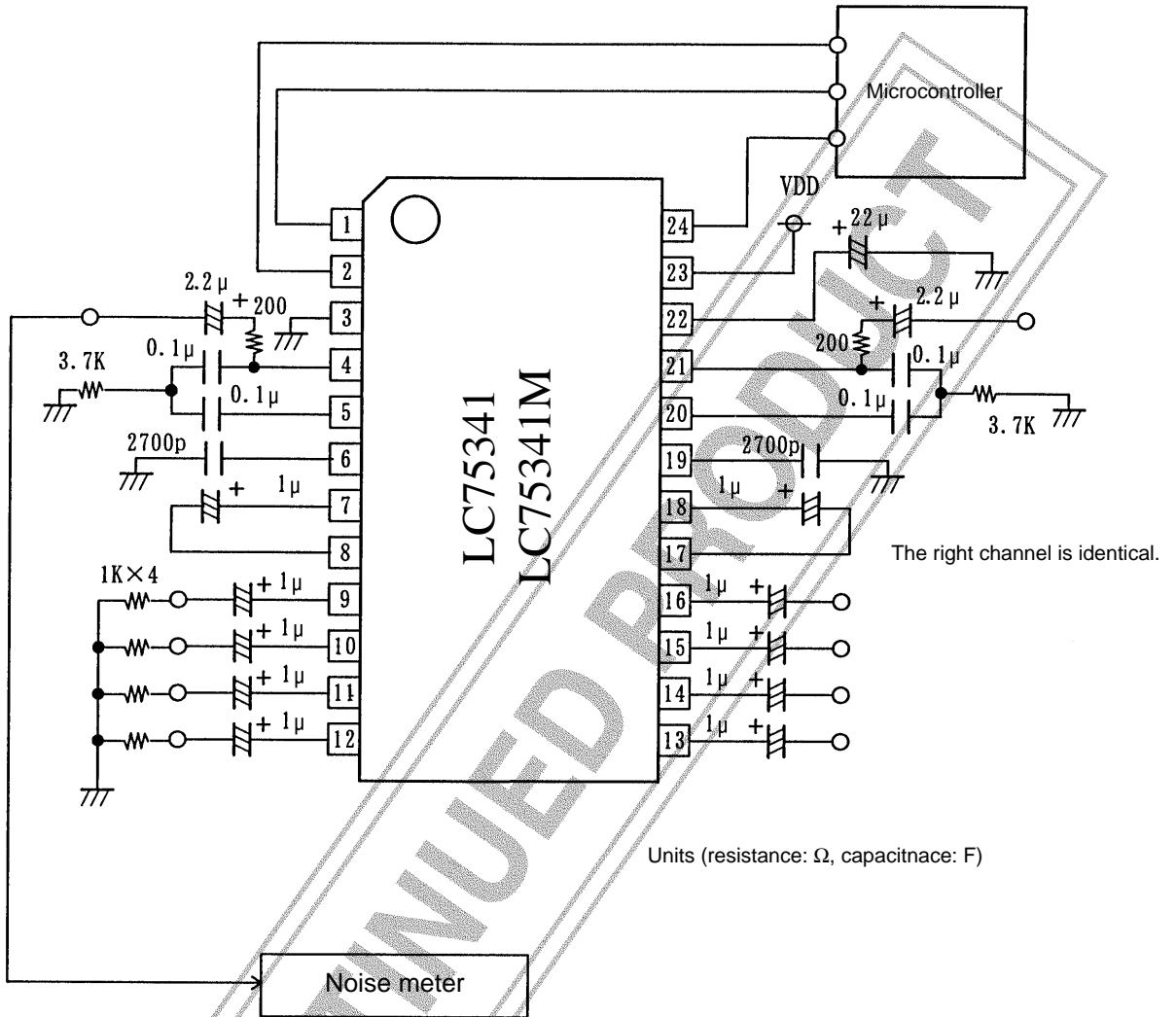

DISCONTINUED PRODUCT

LC75341, 75341M

- Crosstalk

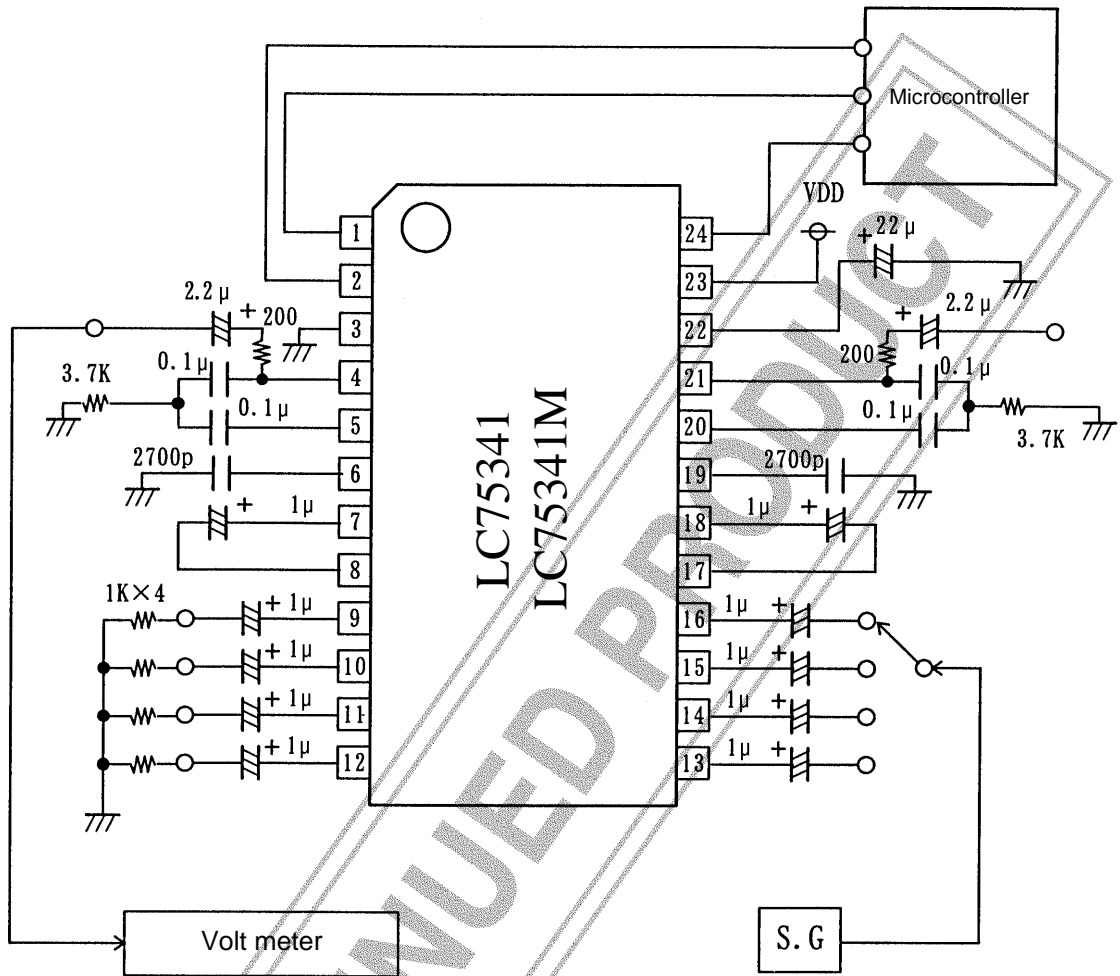

Units (resistance: Ω, capacitance: F)

DISCONTINUED PRODUCT



Bass Band Circuit

This section presents the equivalent circuit and the calculations for the external capacitors and resistors used to achieve a center frequency of 100 Hz.

- Bass band equivalent circuit

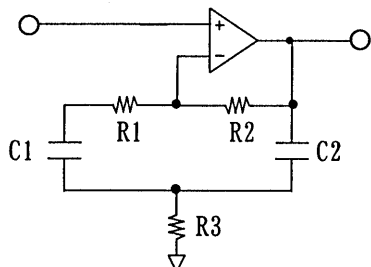

- Sample calculation

Specifications      Center frequency:  $f_0 = 100 \text{ Hz}$   
 Gain at maximum boost:  $G = 20 \text{ dB}$   
 Let  $R_1 = 0$ ,  $R_2 = 66.6 \text{ k}\Omega$ , and  $C_1 = C_2 = C$ .

- (1) Determine  $R_2$  from the fact that  $G = 20 \text{ dB}$ .

$$G_{+20\text{dB}} = 20 \times \text{LOG}_{10} \left( 1 + \frac{R_2}{2R_3} \right)$$

$$R_3 = \frac{R_2}{2(10^{G/20} - 1)} = \frac{66000}{2 \times (10 - 1)} \approx 3.7 \text{ k}\Omega$$

- (2) Determine  $C$  from the fact that the center frequency  $f_0 = 100 \text{ Hz}$ .

$$f_0 = \frac{1}{2\pi \sqrt{R_3 R_2 C_1 C_2}}$$

$$C = \frac{1}{2\pi f_0 \sqrt{R_3 R_2}} = \frac{1}{2\pi \times 100 \sqrt{66000 \times 3700}} \approx 0.1 \mu\text{F}$$

- (3) Determine  $Q$ .

$$Q = \frac{R_3 R_2}{2R_3} \cdot \frac{1}{\sqrt{R_3 R_2}} \approx 2.1$$

- Treble band circuit

The treble band circuit provides shelving characteristics.

This section presents the equivalent circuit in boost mode and the formulas used to calculate the external component values.

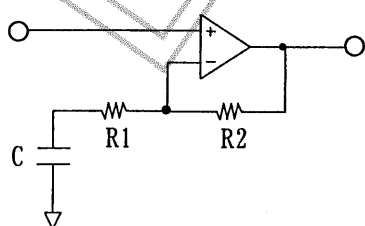

- Sample calculation

Specifications - Set frequency:  $f = 26,000$  Hz

Gain at maximum boost:  $G_{+10dB} = 10$  dB

Let  $R1 = 16.240$  k $\Omega$ ,  $R2 = 35.461$  K $\Omega$ ,

Substitute the above constants into the following formulas.

$$G = 20 \times \text{LOG}_{10} \left( 1 + \frac{R2}{\sqrt{R1^2 + (1 / \omega C)^2}} \right)$$

$$C = \frac{1}{2\pi f \sqrt{\left( \frac{R2}{10^{G/20} - 1} \right)^2 - R1^2}}$$

$$= \frac{1}{2\pi 26000 \sqrt{\left( \frac{35461}{3.16 - 1} \right)^2 - 16240^2}} \approx 2700 \text{ (pF)}$$

#### Usage Notes

- When power is first applied, the states of the internal analog switches will be undefined. Applications must provide external muting until the control data has been transferred and the switches set to appropriate states.
- Applications should transfer both the left and right channel initial settings data before releasing the muting function when initializing this IC after first applying power.
- Applications should cover the CL, DI, and CE pin lines with the ground pattern, or should use shielded cables for these lines to prevent the high-frequency digital signals transmitted over these lines from entering analog signal system.
- When the oscillation occurs, connect a resistor of at least 200  $\Omega$  to LOUT and ROUT pins.

DISCONTINUED PRODUCT

Volume Control Step Characteristics

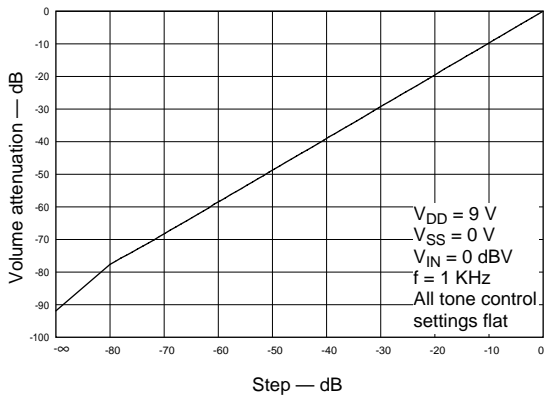

Bass Control Frequency Characteristics

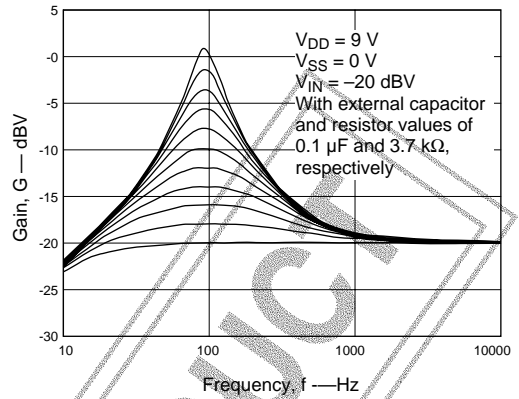

Treble Control Frequency Characteristics

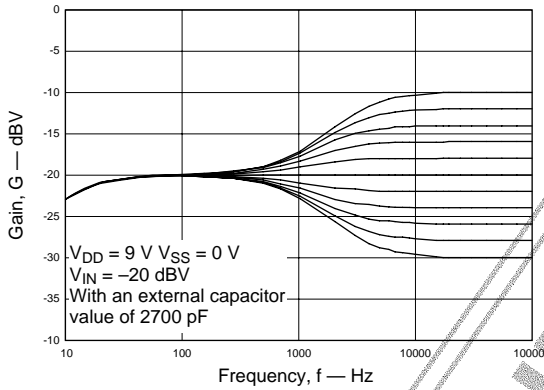

THD - Frequency Characteristics (1)

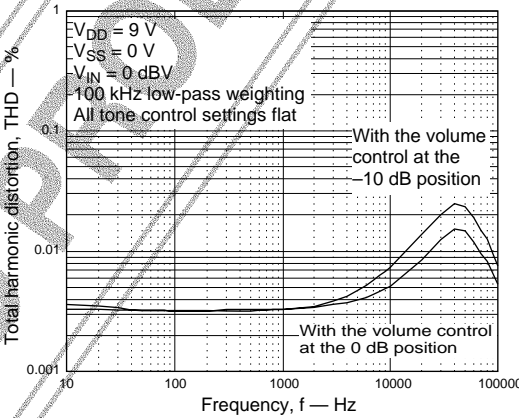

THD - Frequency Characteristics (2)

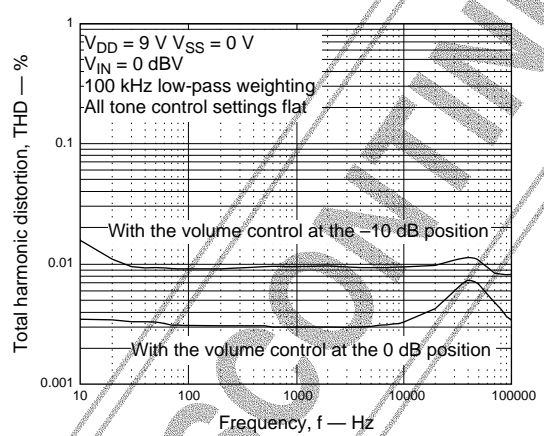

THD - Supply Voltage Characteristics (1)

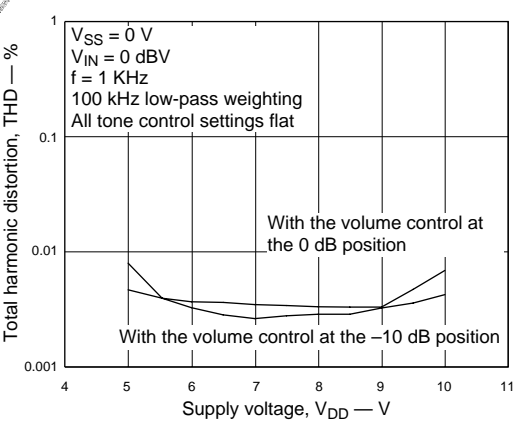

THD - Supply Voltage Characteristics (2)

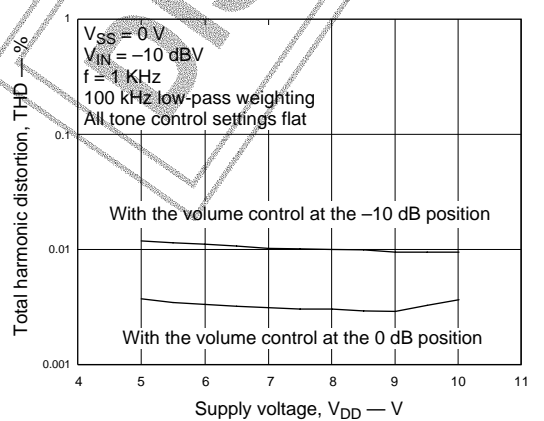

THD - Input Level Characteristics (1)

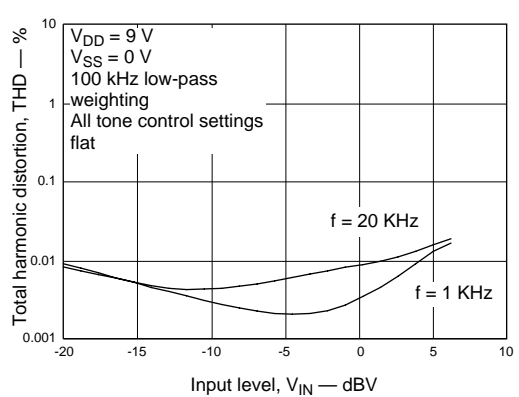

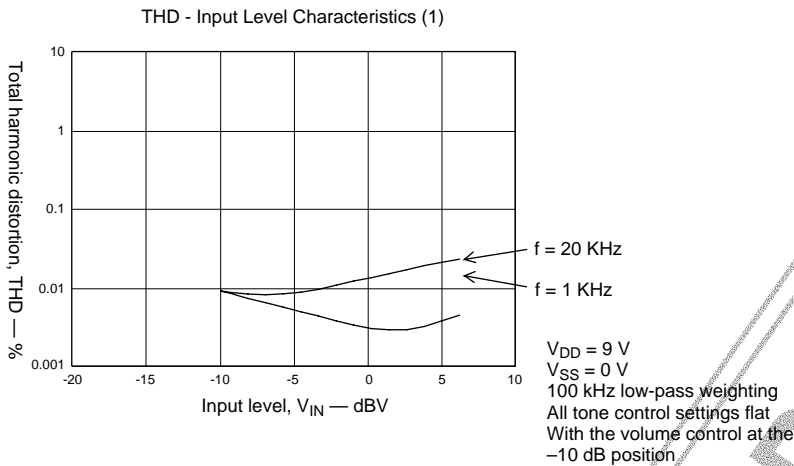

- Specifications of any and all SANYO products described or contained herein stipulate the performance, characteristics, and functions of the described products in the independent state, and are not guarantees of the performance, characteristics, and functions of the described products as mounted in the customer's products or equipment. To verify symptoms and states that cannot be evaluated in an independent device, the customer should always evaluate and test devices mounted in the customer's products or equipment.
- SANYO Electric Co., Ltd. strives to supply high-quality high-reliability products. However, any and all semiconductor products fail with some probability. It is possible that these probabilistic failures could give rise to accidents or events that could endanger human lives, that could give rise to smoke or fire, or that could cause damage to other property. When designing equipment, adopt safety measures so that these kinds of accidents or events cannot occur. Such measures include but are not limited to protective circuits and error prevention circuits for safe design, redundant design, and structural design.
- In the event that any or all SANYO products (including technical data, services) described or contained herein are controlled under any of applicable local export control laws and regulations, such products must not be exported without obtaining the export license from the authorities concerned in accordance with the above law.
- No part of this publication may be reproduced or transmitted in any form or by any means, electronic or mechanical, including photocopying and recording, or any information storage or retrieval system, or otherwise, without the prior written permission of SANYO Electric Co., Ltd.
- Any and all information described or contained herein are subject to change without notice due to product/technology improvement, etc. When designing equipment, refer to the "Delivery Specification" for the SANYO product that you intend to use.
- Information (including circuit diagrams and circuit parameters) herein is for example only; it is not guaranteed for volume production. SANYO believes information herein is accurate and reliable, but no guarantees are made or implied regarding its use or any infringements of intellectual property rights or other rights of third parties.

This catalog provides information as of December, 1999. Specifications and information herein are subject to change without notice.