

PNP SILICON PLANAR MEDIUM POWER DARLINGTON TRANSISTORS

ZTX704
ZTX705

ISSUE 3 – MAY 94

FEATURES

- * 120 Volt V_{CE0}
- * 1 Amp continuous current
- * Gain of 3K at $I_C=1$ Amp
- * $P_{tot}=1$ Watt

APPLICATIONS

- * Lamp, solenoid and relay drivers

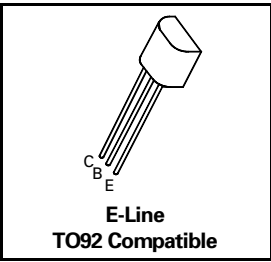

ABSOLUTE MAXIMUM RATINGS.

PARAMETER	SYMBOL	ZTX704	ZTX705	UNIT
Collector-Base Voltage	V_{CBO}	-120	-140	V
Collector-Emitter Voltage	V_{CEO}	-100	-120	V
Emitter-Base Voltage	V_{EBO}		-10	V
Peak Pulse Current	I_{CM}		-4	A
Continuous Collector Current	I_C		-1	A
Power Dissipation at $T_{amb} = 25^\circ\text{C}$ derate above 25°C	P_{tot}		1 5.7	W mW/°C
Operating and Storage Temperature Range	$T_j; T_{stg}$		-55 to +200	°C

ELECTRICAL CHARACTERISTICS (at $T_{amb} = 25^\circ\text{C}$ unless otherwise stated).

PARAMETER	SYMBOL	ZTX704		ZTX705		UNIT	CONDITIONS.
		MIN.	MAX.	MIN.	MAX.		
Collector-Base Breakdown Voltage	$V_{(BR)CBO}$	-120		-140		V	$I_C=-100\mu\text{A}$
Collector-Emitter Breakdown Voltage	$V_{CEO(SUS)}$	-100		-120		V	$I_C=-10\text{mA}^*$
Emitter-Base Breakdown Voltage	$V_{(BR)EBO}$	-10		-10		V	$I_E=-100\mu\text{A}$
Collector Cut-Off Current	I_{CBO}		-0.1 -10		-0.1 -10	μA μA μA μA	$V_{CB}=-100\text{V}$ $V_{CB}=-120\text{V}$ $V_{CB}=-100\text{V}, T_{amb}=100^\circ\text{C}$ $V_{CB}=-120\text{V}, T_{amb}=100^\circ\text{C}$
Collector Cut-Off Current	I_{CES}		-10		-10	μA	$V_{CES}=-80\text{V}$
Emitter Cut-Off Current	I_{EBO}		-0.1		-0.1	μA	$V_{EB}=-8\text{V}$
Collector-Emitter Saturation Voltage	$V_{CE(sat)}$		-1.3 -2.5		-1.3 -2.5	V V	$I_C=-1\text{A}, I_B=-1\text{mA}^*$ $I_C=-2\text{A}, I_B=-2\text{mA}^*$
Base-Emitter Saturation Voltage	$V_{BE(sat)}$		-1.8		-1.8	V	$I_C=-1\text{A}, I_B=-10\text{mA}^*$
Base-Emitter Turn-On Voltage	$V_{BE(on)}$		-1.7		-1.7	V	$I_C=-1\text{A}, V_{CE}=-5\text{V}^*$

ZTX704 ZTX705

ELECTRICAL CHARACTERISTICS (at $T_{amb} = 25^{\circ}\text{C}$).

PARAMETER	SYMBOL	ZTX704		ZTX705		UNIT	CONDITIONS.
		MIN.	MAX.	MIN.	MAX.		
Static Forward Current Transfer Ratio	h_{FE}	3K 3K 3K 2K	30K	3K 3K 3K 2K	30K		$I_C = -10\text{mA}, V_{CE} = -5\text{V}^*$ $I_C = -100\text{mA}, V_{CE} = -5\text{V}^*$ $I_C = -1\text{A}, V_{CE} = -5\text{V}^*$ $I_C = -2\text{A}, V_{CE} = -5\text{V}^*$
Transition Frequency	f_T	160 Typical		160 Typical		MHz	$I_C = -100\text{mA}, V_{CE} = -10\text{V}$ $f = 20\text{MHz}$
Input Capacitance	C_{ibo}	90 Typical		90 Typical		pF	$V_{EB} = -0.5\text{V}, f = 1\text{MHz}$
Output Capacitance	C_{obo}	15 Typical		15 Typical		pF	$V_{CE} = -10\text{V}, f = 1\text{MHz}$
Switching Times	t_{on}	0.6 Typical		0.6 Typical		μs	$I_C = -0.5\text{A}, V_{CE} = -10\text{V}$ $I_{B1} = I_{B2} = -0.5\text{mA}$
	t_{off}	0.8 Typical		0.8 Typical		μs	

*Measured under pulsed conditions. Pulse width=300 μs . Duty cycle $\leq 2\%$

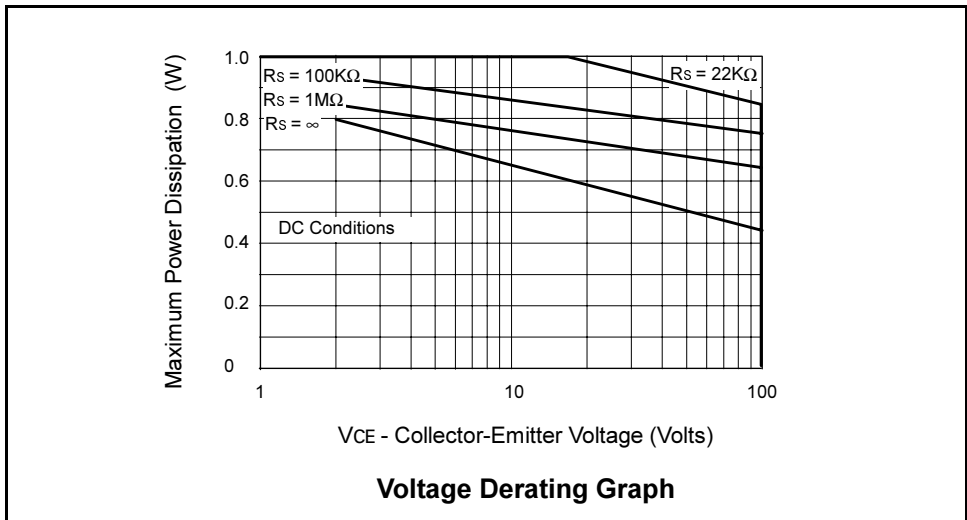

The maximum permissible operational temperature can be obtained from this graph using the following equation

$$T_{amb(max)} = \frac{Power(max) - Power(act)}{0.0057} + 25^{\circ}\text{C}$$

$T_{amb(max)}$ = Maximum operating ambient temperature

Power(max) = Maximum power dissipation figure, obtained from the above graph for a given V_{CE} and source resistance (R_S)

Power(actual) = Actual power dissipation in users circuit

ZTX704 ZTX705

TYPICAL CHARACTERISTICS

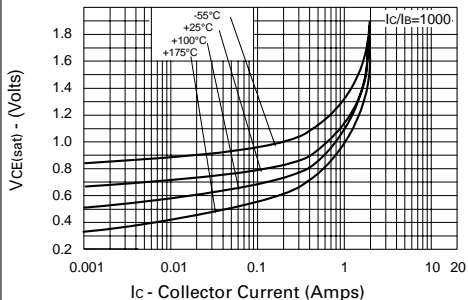

$V_{CE(sat)}$ v I_C

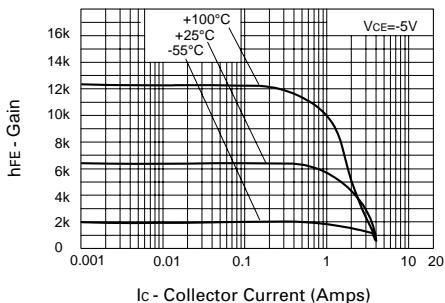

hFE v I_C

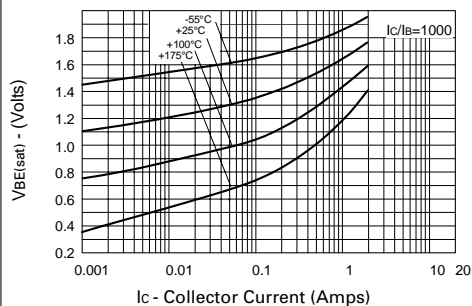

$V_{BE(sat)}$ v I_C

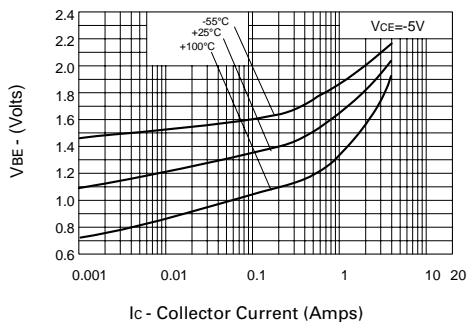

$V_{BE(on)}$ v I_C

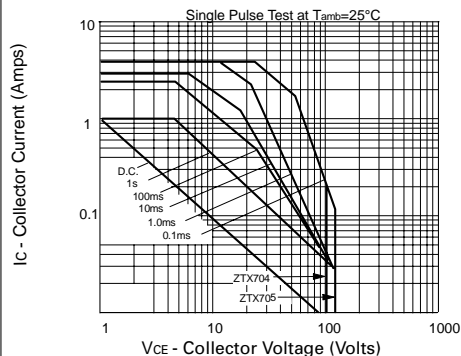

Safe Operating Area