

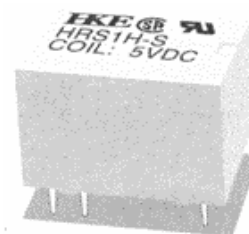

HRS1(H) Relay

1.COIL DATA

1.1 Nominal Voltage.	3 VAC t 24 VAC
1.2 Coil Resistance	refer to Table 1
1.3 Operate Voltage	refer to Table 1
1.4 Release Voltage	refer to Table 1
1.5 Nominal Power Consumption	200 to 360 mW



HRS1(H) Relay

2.CONTACT DATA

2.1 Contact Arrangement	1 Form C
2.2 Contact Material	AuAg
2.3 Contact Rating	1A 24VDC/120VAC
2.4 Max-Switching Voltage	30 VAC/120VAC
2.5 Max-Switching Current	2A
2.6 Max. switching Power	120 VA, 24W
2.7 Contact Resistance (Initial)	100 mΩ at 6 VAC 1A
2.8 Life Expectancy Electrical	100,000 operation at nominal load
Mechanical	10,000,000 operations

3.GENERAL DATA

3.1 Insulation Resistance	Min. 100mΩ at 500 VDC
3.2 Dielectric Strength	1000 VAC, 1 min between open contact 1,500 VAC, 1 min between contact and coil.
3.3 Operate time	Max. 5 mS
3.4 Release Time	Max. 5 mS
3.5 Temperature Range	-25 to +55
3.6 Shock Resistance	10 G
3.7 Vibration Resistance	10 - 55 Hz, Amplitude 1.5mm

4.DIMENSION (in mm)

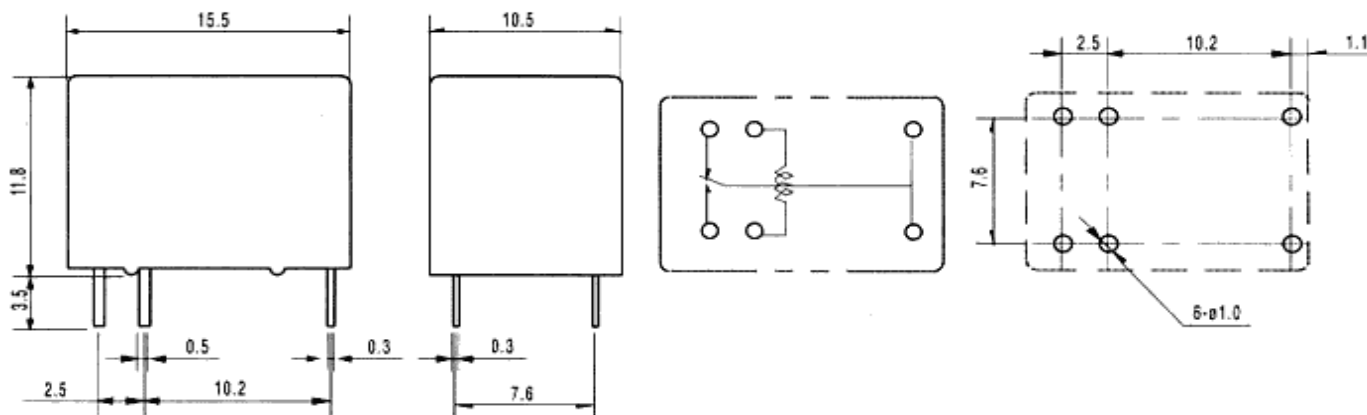

5. ORDERING CODE

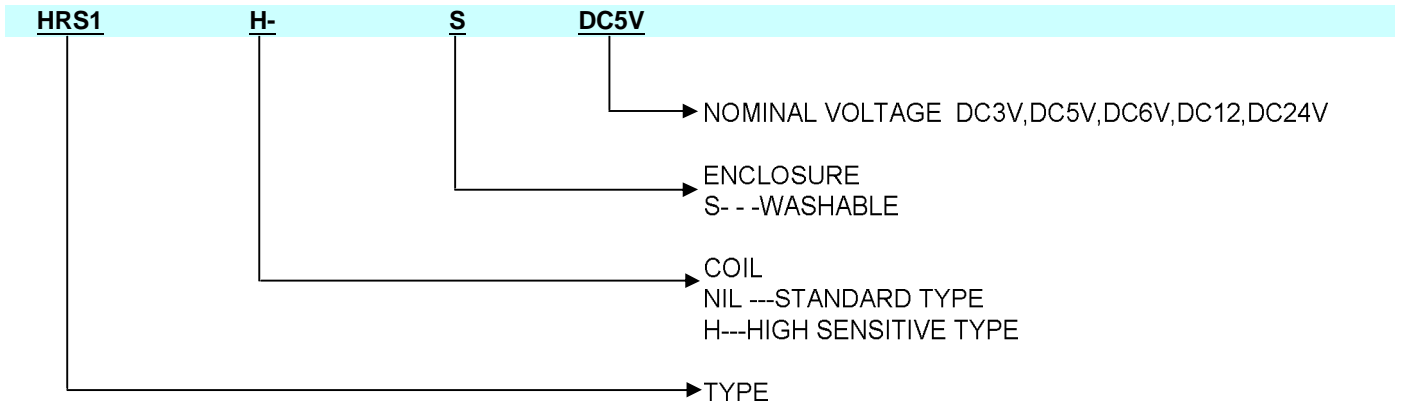

6. COIL DATA CHART

ORDERING CODE	COIL NOMINAL VDC	COIL RESISTANCE +/-10%	OPERATE VOLTAGE VDC	RELEASE VOLTAGE VDC	COIL NOMINAL mW
HRS1-S DC3V	3	25	2.25	0.30	360
HRS1-S DC5V	5	70	3.75	0.50	
HRS1-S DC6V	6	100	4.50	0.60	
HRS1-S DC9V	9	220	6.75	0.90	
HRS1-S DC12V	12	400	9.00	1.20	
HRS1-S DC24V	24	1600	18.00	2.40	
HRS1H-S DC3V	3	45	2.25	0.30	200
HRS1H-S DC5V	5	120	3.75	0.50	
HRS1H-S DC6V	6	180	4.50	0.60	
HRS1H-S DC9V	9	400	6.75	0.90	
HRS1H-S DC12V	12	700	9.00	1.20	
HRS1H-S DC24V	24	2800	18.00	2.40	

Table 1

7. HRS1(H) CHARACTERISTIC DATA

Timing

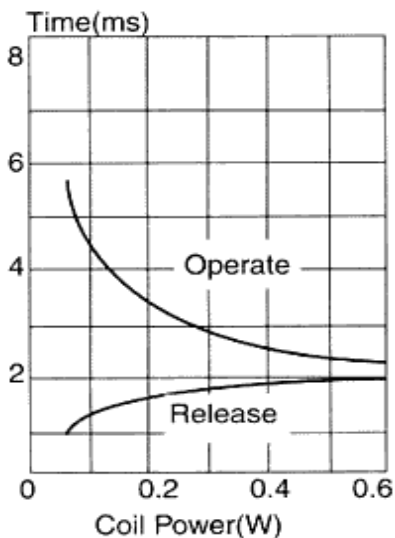

Coil Temperature

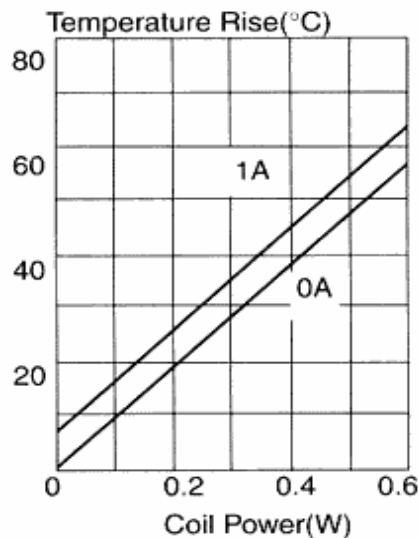

Operating Range

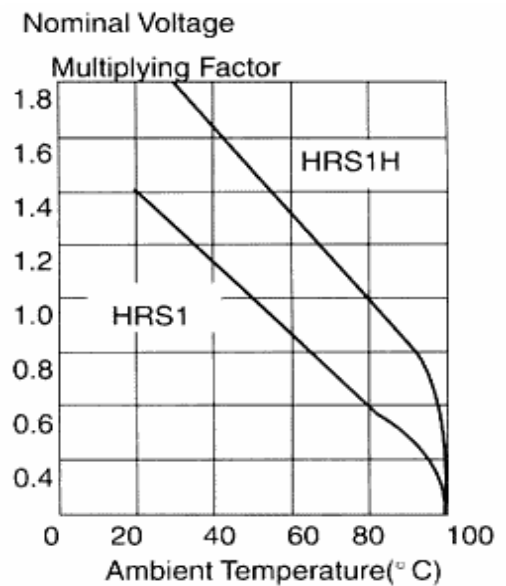

Maximum Switching Power

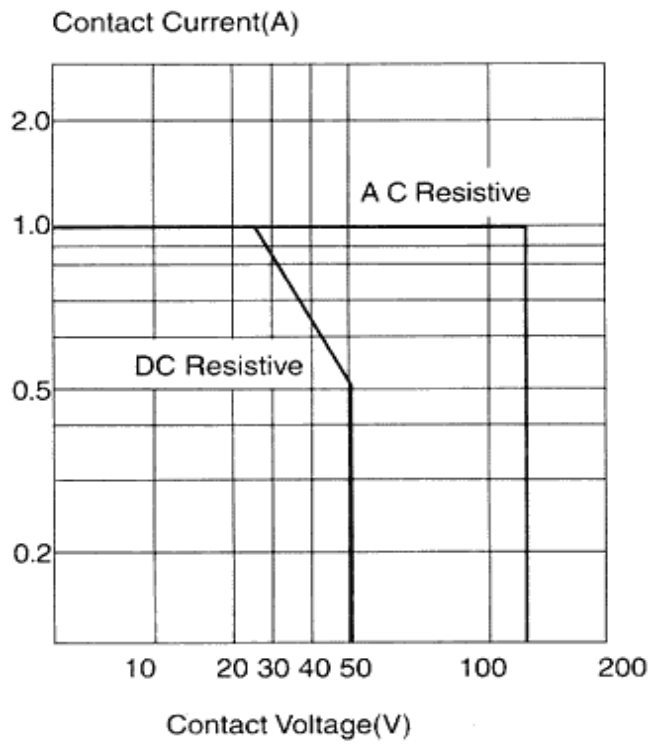

Life Curve

