

ENERGIZER NO. EN91

AA

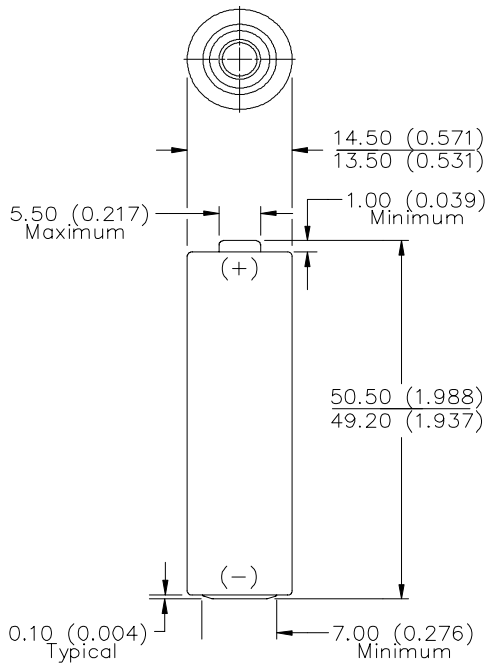

Industry Standard Dimensions in mm (inches)



NOT INTENDED FOR RETAIL TRADE

Chemical System: Alkaline
 Zinc-Manganese Dioxide (Zn/MnO₂)
 (No Added Mercury or Cadmium)

Designation: ANSI-15A, IEC-LR6

Battery Voltage: 1.5 Volts

Internal Resistance: 146 Milliohms (Fresh)

Operating Temp: -18°C to 55°C (0°F to 130°F)

Average Capacity: 2,779 mAh (to 0.8 volts)
 (Rated capacity at 25 mA continuous drain)

Average Weight: 23.0 grams (0.8 oz.)

Volume: 8.1 cubic centimeters (0.5 cubic inch)

Cell: One No. 3-315 (size 'AA')

Jacket: Plastic Label

Shelf Life: 7 years (80% of rated capacity)

TEMPERATURE EFFECTS

Typical Service to 0.8 Volts

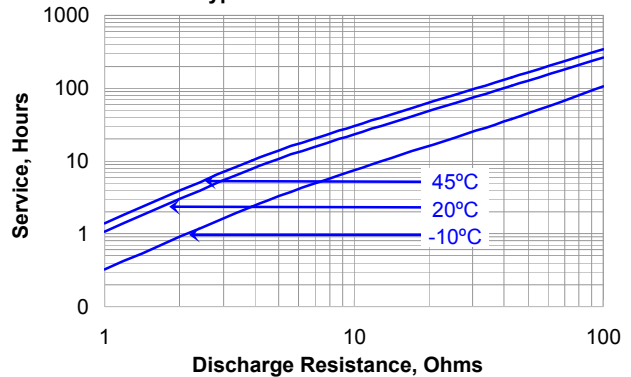

CONSTANT RESISTANCE PERFORMANCE

Typical Service

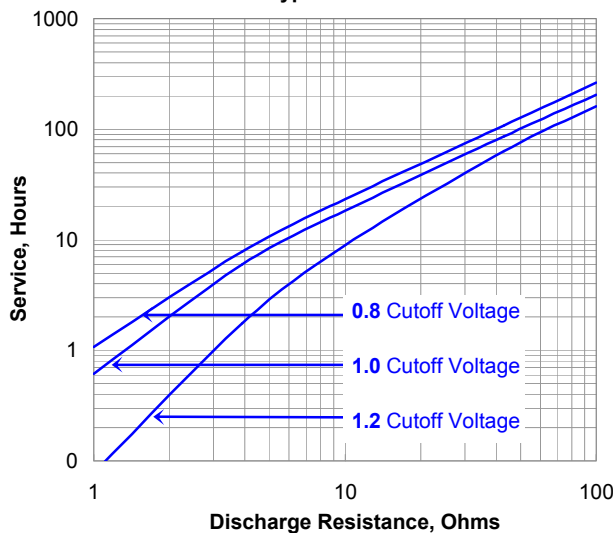

CONSTANT CURRENT DISCHARGE

Typical Service

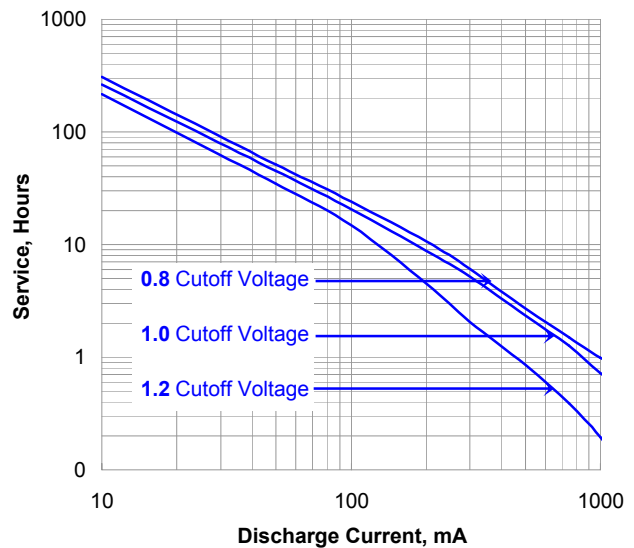

Important Notice

This data sheet contains information specific to batteries manufactured at the time of its publication.

Contents herein do not constitute a warranty.

Copyright © Eveready Battery Co. - All rights reserved

ENERGIZER NO. EN91

CONSTANT POWER DISCHARGE
Typical Service

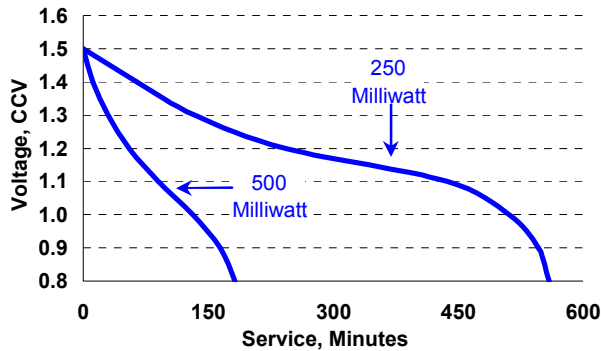

CONSTANT POWER DISCHARGE
Typical Service

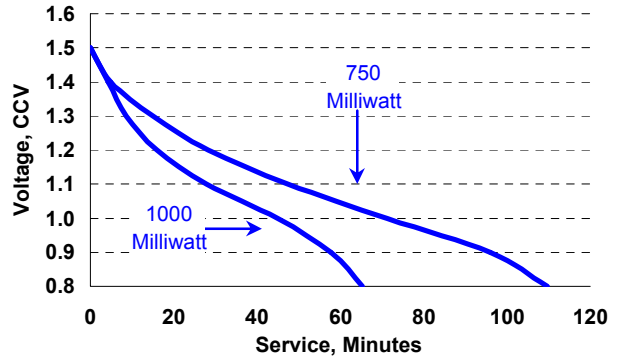

Industry Standard Tests @ 20° C

RADIO
43 ohm - 4 hours/day

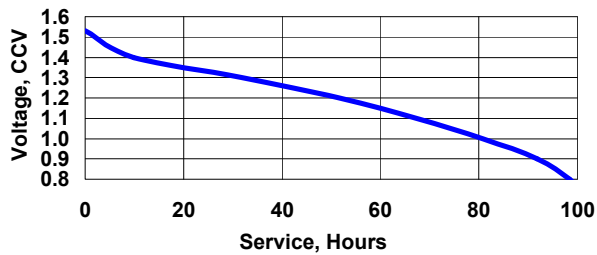

LIGHTING 3.3 ohm - LIF TOY 3.9 ohm - 1 hr/day

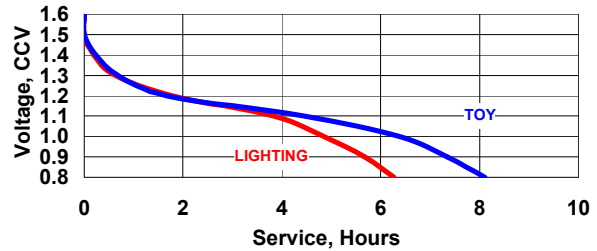

REMOTE
24 ohm - 15 spm - 8 hr/day

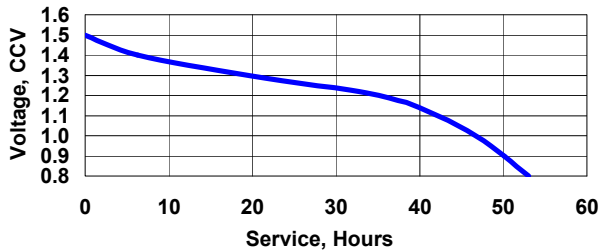

TAPE PLAYER
100 mA - 1 hr/day



CD / MD / ELEC GAME
250 mA - 1 hr/day

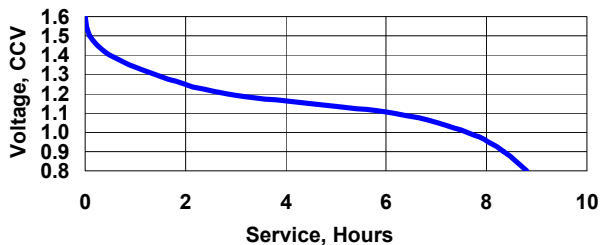

DIGITAL CAMERA 1.5/6.5K mW 2/28s 10X/hr PHOTO 1000 mA 10 sec/min 1 hr/day

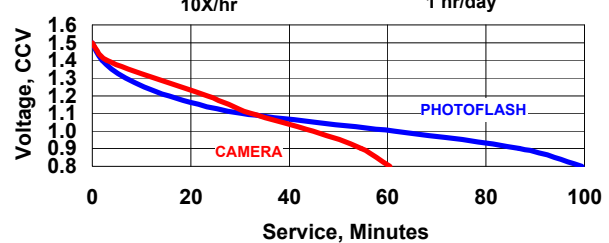

Important Notice

This data sheet contains information specific to batteries manufactured at the time of its publication.

Contents herein do not constitute a warranty.

Copyright © Eveready Battery Co. - All rights reserved