

MITSUBISHI RF POWER TRANSISTOR 2SC1729

NPN EPITAXIAL PLANAR TYPE

DESCRIPTION

2SC1729 is a silicon NPN epitaxial planar type transistor designed for RF power amplifiers on VHF band mobile radio applications.

FEATURES

- High power gain: $G_{pe} \geq 10\text{dB}$
@ $V_{CC} = 13.5\text{V}$, $P_O = 14\text{W}$, $f = 175\text{MHz}$
- Emitter ballasted construction and gold metallization for high reliability and good performances.
- Low thermal resistance ceramic package with flange.
- Ability of withstanding more than 20:1 and load VSWR when operated at $V_{CC} = 15.2\text{V}$, $P_O = 18\text{W}$, $f = 175\text{MHz}$.

APPLICATION

10 to 14 watts output power amplifiers applications in VHF band.

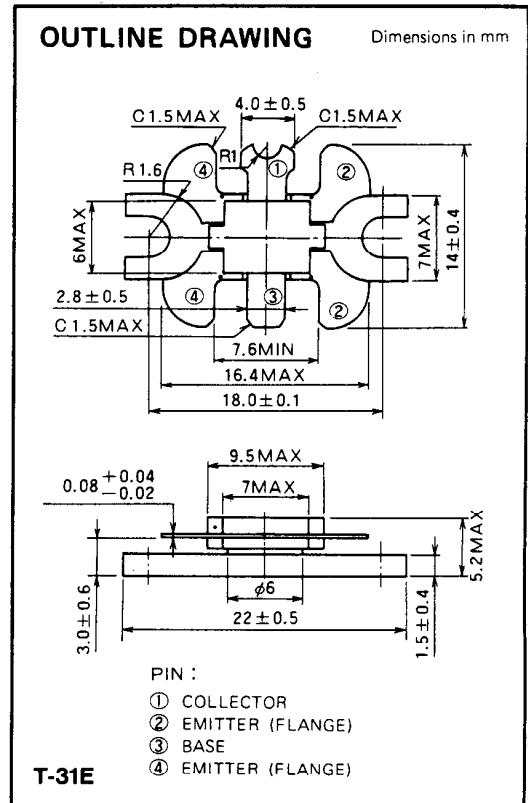

ABSOLUTE MAXIMUM RATINGS ($T_C = 25^\circ\text{C}$ unless otherwise specified)

Symbol	Parameter	Conditions	Ratings	Unit
V_{CBO}	Collector to base voltage		35	V
V_{EBO}	Emitter to base voltage		4	V
V_{CEO}	Collector to emitter voltage	$R_{BE} = \infty$	17	V
I_C	Collector current		3.5	A
P_C	Collector dissipation	$T_a = 25^\circ\text{C}$	2.5	W
		$T_C = 25^\circ\text{C}$	35	W
T_J	Junction temperature		175	$^\circ\text{C}$
T_{stg}	Storage temperature		-65 to 175	$^\circ\text{C}$
R_{th-a}	Thermal resistance	Junction to ambient	60	$^\circ\text{C}/\text{W}$
R_{th-c}		Junction to case	4.3	$^\circ\text{C}/\text{W}$

Note. Above parameters are guaranteed independently.

ELECTRICAL CHARACTERISTICS ($T_C = 25^\circ\text{C}$ unless otherwise specified)

Symbol	Parameter	Test conditions	Limits			Unit
			Min	Typ	Max	
$V_{(BR)EBO}$	Emitter to base breakdown voltage	$I_E = 10\text{mA}$, $I_C = 0$	4			V
$V_{(BR)CBO}$	Collector to base breakdown voltage	$I_C = 10\text{mA}$, $I_E = 0$	35			V
$V_{(BR)CEO}$	Collector to emitter breakdown voltage	$I_C = 50\text{mA}$, $R_{BE} = \infty$	17			V
I_{CBO}	Collector cutoff current	$V_{CB} = 25\text{V}$, $I_E = 0$			1	mA
I_{EBO}	Emitter cutoff current	$V_{EB} = 3\text{V}$, $I_C = 0$			0.5	mA
h_{FE}	DC forward current gain *	$V_{CE} = 10\text{V}$, $I_C = 0.1\text{A}$	10	50	180	—
P_O	Output power	$V_{CC} = 13.5\text{V}$, $P_{in} = 1.4\text{W}$, $f = 175\text{MHz}$	14	16		W
η_C	Collector efficiency		60	70		%

Note. * Pulse test, $P_W = 150\mu\text{s}$, duty = 5%.

Above parameters, ratings, limits and conditions are subject to change.

NOV. '97

NPN EPITAXIAL PLANAR TYPE

TEST CIRCUIT

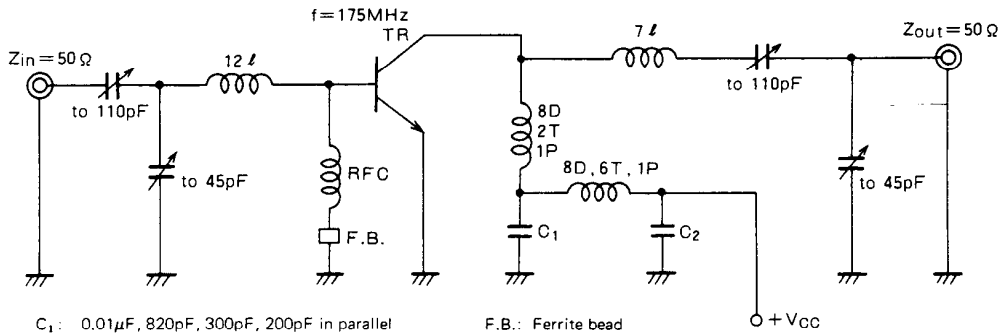

C_1 : 0.01 μ F, 820pF, 300pF, 200pF in parallel
 C_2 : 22 μ F, 0.1 μ F, 0.02 μ F, 300pF in parallel
 Notes: All coils are made from 1.5mm ϕ silver plated copper wire
 Coil dimensions in milli-meter
 D: Inner diameter of coil
 T: Turn number of coil
 P: Pitch of coil
 λ : Length

TYPICAL PERFORMANCE DATA

COLLECTOR DISSIPATION VS. AMBIENT TEMPERATURE

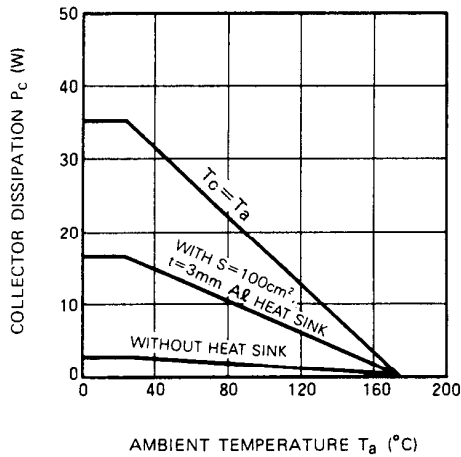

COLLECTOR CURRENT VS. COLLECTOR TO EMITTER VOLTAGE

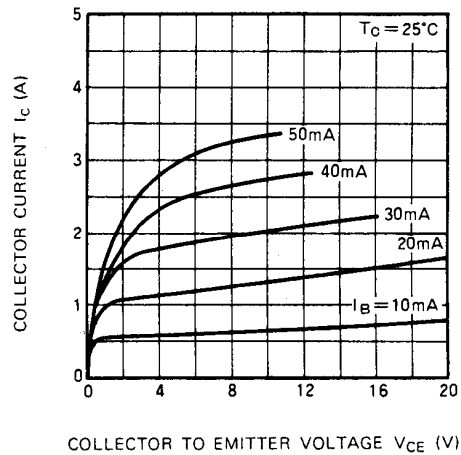

COLLECTOR TO EMITTER BREAKDOWN VOLTAGE VS. BASE TO EMITTER RESISTANCE

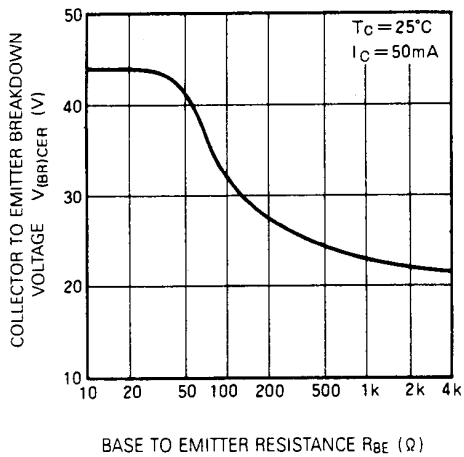

DC CURRENT GAIN VS. COLLECTOR CURRENT

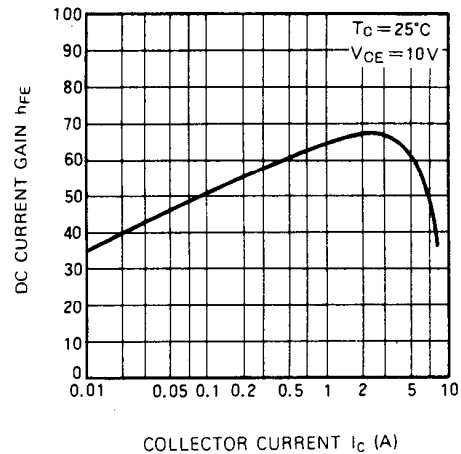

COLLECTOR OUTPUT CAPACITANCE VS. COLLECTOR TO BASE VOLTAGE

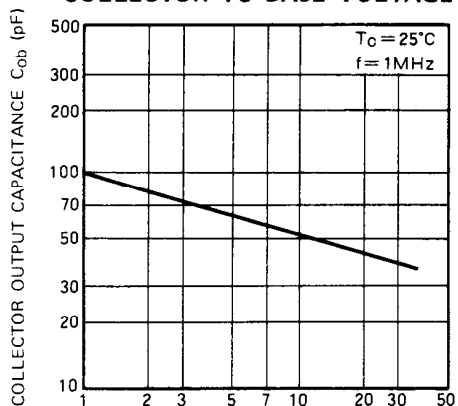

COLLECTOR TO BASE VOLTAGE V_{cb} (V)

OUTPUT POWER, COLLECTOR EFFICIENCY VS. INPUT POWER

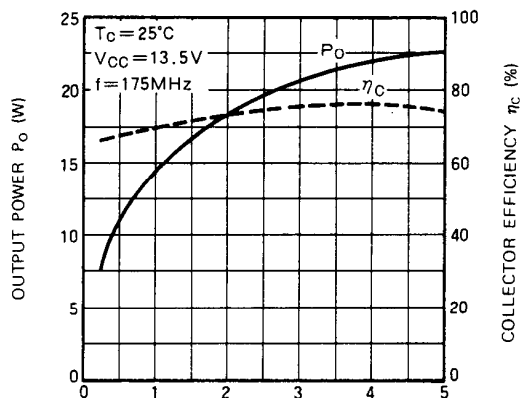

INPUT POWER P_{in} (W)

OUTPUT POWER VS. COLLECTOR SUPPLY VOLTAGE

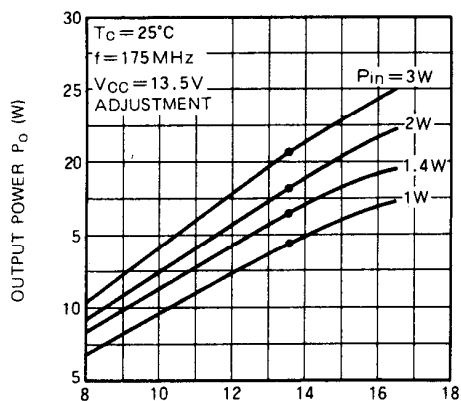

COLLECTOR SUPPLY VOLTAGE V_{cc} (V)

This datasheet has been download from:

www.datasheetcatalog.com

Datasheets for electronics components.