

RFID Application Kit TMEB8704

Table of Contents

1 Introduction	3
2 Getting Started	3
2.1 Minimum System Requirements	3
2.2 Hardware Requirements and Installation	3
2.3 Hardware Settings and Connector Positions (Fig. 1, 2)	3
2.4 Software Installation	5
3 Description of the Application Board System	5
3.1 System Overview	5
3.2 Power Supply	5
3.3 Antenna Interface	5
3.3.1 Frequency Tuning Mode Selection	5
3.3.2 RF Field Control	5
3.3.3 Circuit Diagram of the Antenna Interface	6
3.3.4 Part List of the Antenna Interface	7
4 Identification Application Software IDS 5	8
4.1 Getting Started	8
4.1.1 Using the TK5530 Read-Only Transponder	8
4.1.2 Using the TK5551 Read/Write Transponder	8
4.1.3 Using the TK5552 Read/Write Transponder	8
4.1.4 Using the TK5561 Read/Write/Crypto Transponder	8
4.1.5 Using the U9280M Read/Write/Crypto	9
4.1.6 Exit the Program	9
5 Description of the RFID Application Kit Software IDS 5	9
5.1 Software Structure	9
5.2 Start Window	10
5.2.1 Setup	10
5.2.2 Option	10
5.2.3 Application	11
5.2.4 Exit	11
5.2.5 Info	11
5.3 TK5530 Read Only Transponder	11
5.4 TK5551 Read/Write Transponder	12
5.4.1 Answer On Request	14
5.5 TK5552 Read/Write Transponder	15
5.6 TK5561 Read/Write/Crypto Transponder	17
5.6.1 Authentication	19
5.7 U9280M Microcontroller with Transponder Interface	20
5.7.1 Authentication	22

1 Introduction

The RFID application kit (Order number: TMEB8704) is designed to present the key features of various RFID products from Atmel Wireless & Microcontrollers. The included software version IDS 5 supports the following products:

- U2270B on the reader side
- TK5530 / e5530 on the transponder side
- TK5551 / e5551 on the transponder side
- TK5552 on the transponder side
- TK5561 / e5561 on the transponder side
- U9280M on the transponder side

2 Getting Started

For proper operation of the demonstration system, the following requirements have to be met:

2.1 Minimum System Requirements

- Pentium® processor based PC
- 16 MB RAM memory
- Windows 95 operation software or higher
- CD-ROM drive
- VGA monitor
- Serial interface RS232 com1 or com2
- Mouse

2.2 Hardware Requirements and Installation

- μC-board 1.0 with application kit 5
- R/W antenna 100 mm \varnothing / L = 700 μH / Q = 36
- Serial communication cable RS232
- Power source 12 V AC/DC / 200 mA
- Jack connector cable for power supply

The following interconnection and conditions are required:

- The antenna must be plugged into the socket of the interface board.
- Communication cabling between RS232 connector and com1 or com2 interface of the PC
- Supply line from the power source to the jack connector
- Set the power switch to position ON

2.3 Hardware Settings and Connector Positions (Fig. 1, 2)

In case of the RFID application, the main board with the microcontroller is operated in a fixed configuration, no settings are necessary. The jumper J3 on the antenna interface has to be checked according to the default setting.

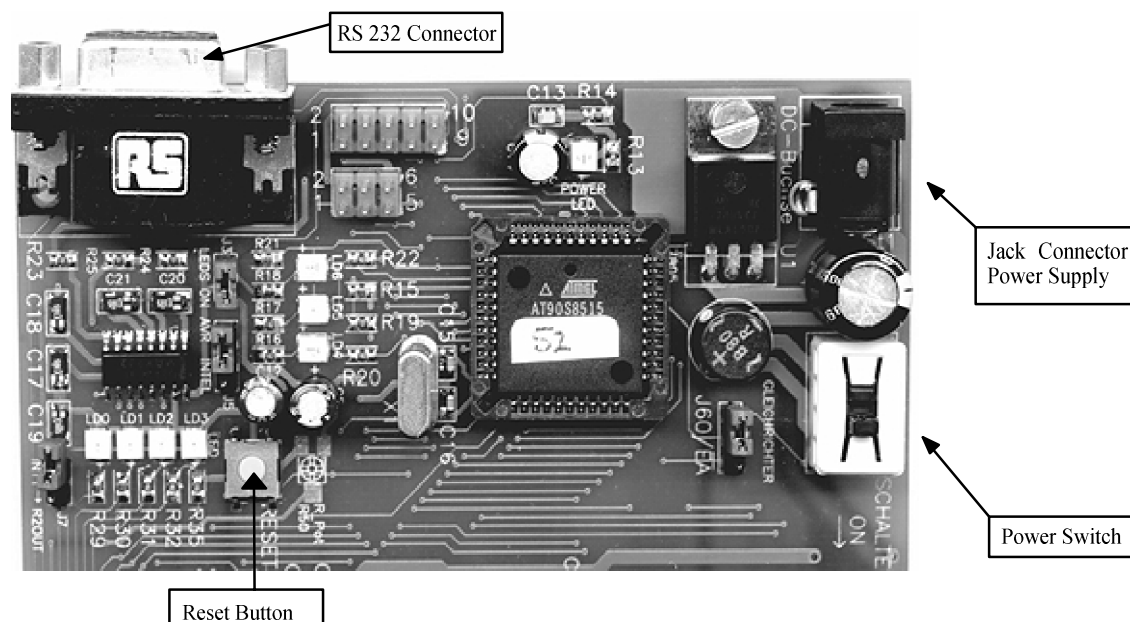

Figure 1. Main board

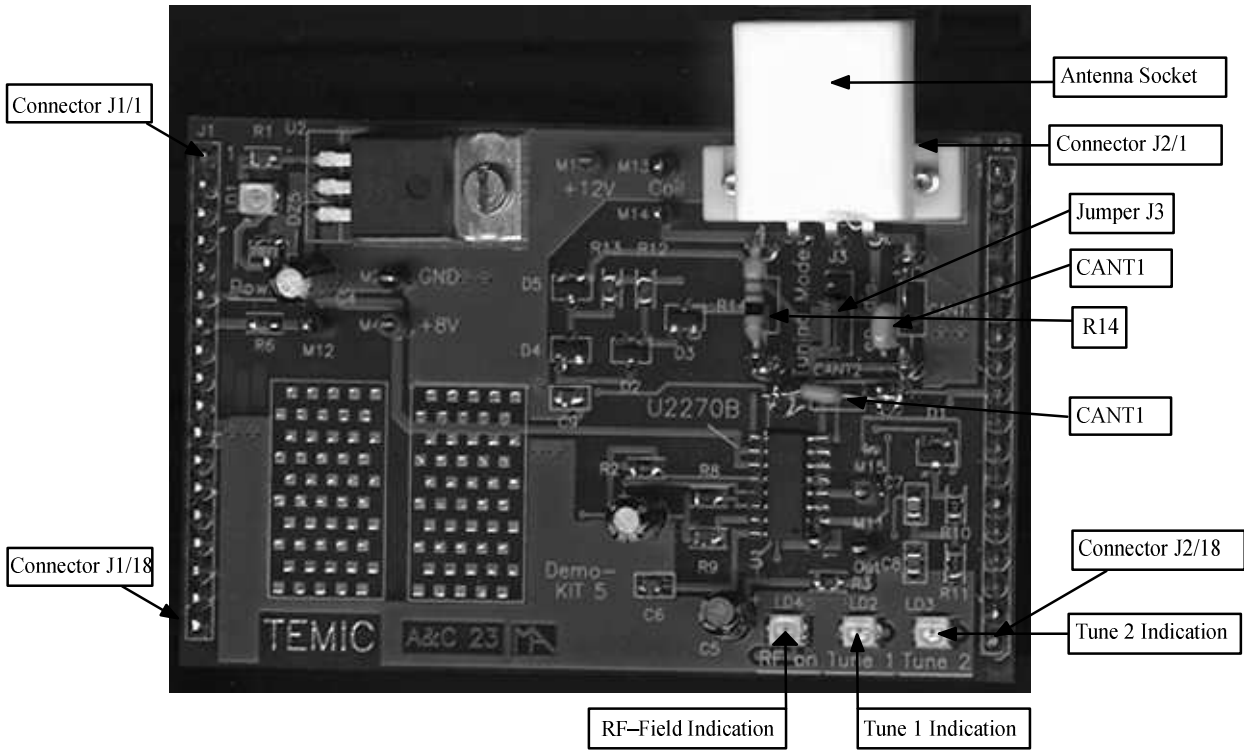

Figure 2. Antenna interface board

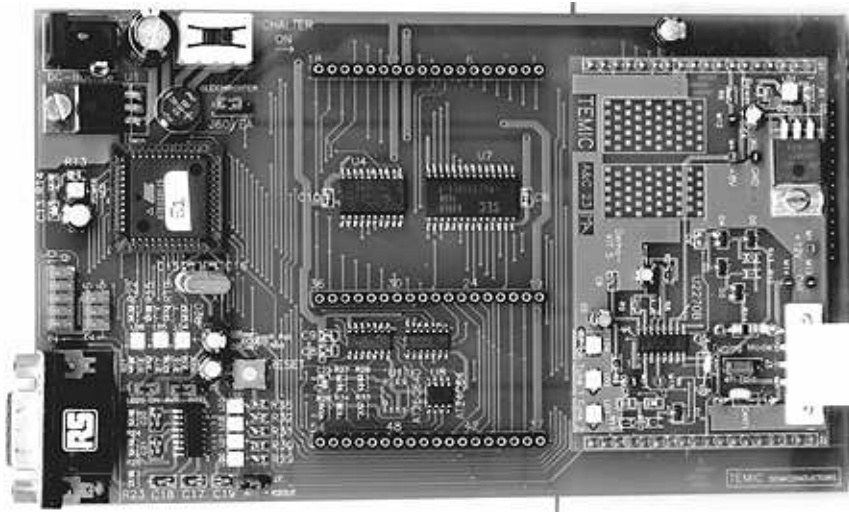

Figure 3. Application board topview

2.4 Software Installation

The RFID application kit package includes a CD-ROM with the installation program and the description of the RFID application kit on the cover.

Insert the CD-ROM into the CD-ROM drive and start the setup.exe file by means of the Windows Explorer. Then the application program (incl. all libraries needed) will be installed automatically step by step.

Remark:

Rights for writing into the system have to be given.

3 Description of the Application Board System

3.1 System Overview

The RFID application board consists of a standard main board µC-board 1.0 equipped with the Atmel microcontroller AT90S8515 combined with a piggybacked board serving as the antenna interface.

The microcontroller AT90S8515 carries out the following functions:

- Handling of the bidirectional data communication between RS232 and host PC
- Execution of the read and write commands to be sent to the antenna interface
- Decoding of the specific read data delivered by the antenna interface

Therefore, a source program in C-language has been written. The compiled hex code is downloaded in the 8 k flash memory of the micro. The actual program version is indicated on the label placed on the main board.

3.2 Power Supply

For proper operation of the application board, an external power supply in the range of DC 10 V to 15 V/ 200 mA has to be connected to jack. A bridge rectifier placed at the connector input is used for polarity independence.

3.3 Antenna Interface

The antenna interface (figure 2) is supplied via the jack connector located on the main board. The LED “Power”

indicates the actual supply voltage. For the adaption of a specific antenna coil to the resonant frequency and the Q-factor, the components CANT1 / CANT2 and R14 (figure 2) can be changed. The matching of the interface depends on the added coil. The parameters and the corresponding components for the adjustment are described below:

Resonant frequency:

fres = 125 kHz by CANT1 / CANT2 @ Jumper 3 to position “Disable”

Q-factor: Q = 20 by R14

3.3.1 Frequency Tuning Mode Selection

The application system has a built-in tuning feature to match the resonant frequency of the LC antenna circuit automatically to the frequency of a specific transponder. The board is equipped with two stages of high-voltage transistor switches to tune the resonator by switched capacitors. This increases the reliability and operating distance.

The frequency tuning can be selected by the jumper J3 (figure 2):

Tuning Mode	Position Jumper J3
Disabled	1–2
Enabled	2–3

In disabled mode, the RFID application kit operates with the fixed frequency, adjusted nominally to 125 kHz. The tuning mode has to be enabled in order to control the tuning by the RFID application program. The binary combination of two tuning stages enables to select one out of four frequency states. The frequency range is extended typically from 122 kHz to 128 kHz in steps of 2 kHz (specified in the menu of the program by “low”, “semi-low”, “semi-high” and “high”).

The currently selected frequency stage is indicated in binary mode on the application board by the red LEDs “Tune 1” and “Tune 2” (figure 2).

3.3.2 RF Field Control

The status of the RF field controlled by the microcontroller is indicated by the yellow LED “RF on”.

3.3.3 Circuit Diagram of the Antenna Interface

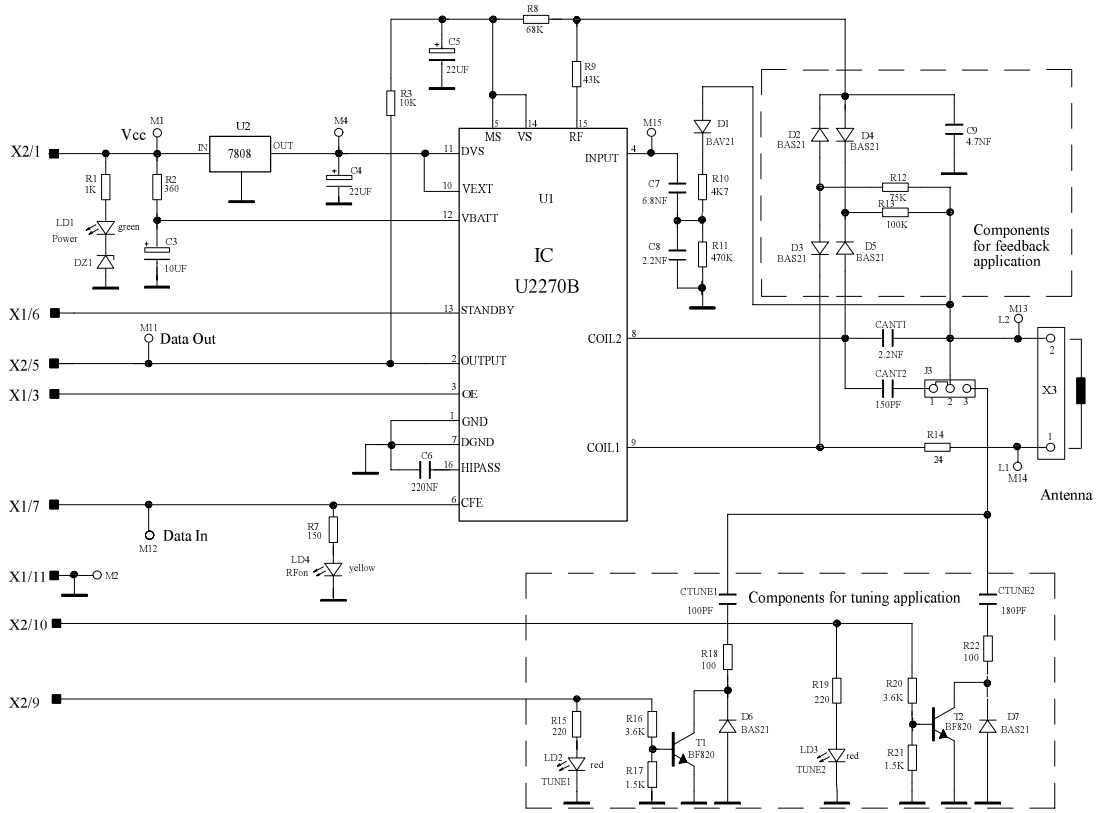

Figure 4. Circuit diagram of the antenna interface

3.3.4 Part List of the Antenna Interface

U1	=	U 2270 B	SO16	R14	=	24 Ω	0805
U2	=	LM7808	TO220	R15	=	1 kΩ	0805
Diodes:				R16	=	3.6 kΩ	0805
D1	=	BAS21	SOT23	R17	=	1.5 kΩ	0805
D2	=	BAS21	SOT23	R18	=	100 Ω	0805
D3	=	BAS21	SOT23	R19	=	1 kΩ	0805
D4	=	BAS21	SOT23	R20	=	3.6 kΩ	0805
D5	=	BAS21	SOT23	R21	=	1.5 kΩ	0805
D6	=	BAS21	SOT23	R22	=	100 Ω	0805
D7	=	BAS21	SOT23	Capacitors:			
DZ1	=	BZX84C 5.6V	SOT23	CANT1	=	2.2 nF (5%)	
LED:				CANT2	=	150 pF	
LD1	=	TLMC3100 (green)	PLCC2	CTUNE1	=	100 pF	0805
LD2	=	TLMT3100 (red)	PLCC2	CTUNE2	=	180 pF	0805
LD3	=	TLMT3100 (red)	PLCC2	C3	=	10 μF / 16 V	
LD4	=	TLMA3100 (yellow)	PLCC2	C4	=	22 μF / 16 V	
Transistors:				C5	=	22 μF / 16 V	
				C6	=	220 nF	0805
				C7	=	22 nF	0805
				C8	=	22 nF	0805

4 Identification Application Software IDS 5

4.1 Getting Started

- Read this RFID application kit user's manual
- Install the IDS 5 software
- Connect a RS232 serial cable to the RFID application kit and to the PC
- Connect a 12 V (AC or DC) power supply to the RFID application kit (using the jack connector). The status "Power on" is indicated by a green LED near the microcontroller.
- Start the program **RFID Application Software**
- Select the COM port to be used in the Setup menu

4.1.1 Using the TK5530 Read-Only Transponder

- Select the transponder type
→ Setup...Transponder...TK5530
- Place a transponder close to the base-station antenna
- Enter the transponder's configuration details such as bitrate, coding, ID-code length, signature and header.

- To read out the transponder, click on the "Read" button in the index "Read" to show the transponder code

4.1.3 Using the TK5552 Read/Write Transponder

- Select the transponder type
→ Setup...Transponder...TK5552
- Place a transponder close to the base-station antenna
- Enter the transponder's configuration details such as bitrate, coding, ID-code length and signature. (For non-applications, use the default settings)
- Click on "Configure Transponder" (this function programs the configuration block – block 0 – of the TK5552)
- Choose the index "Write" to program block 1...31 of the transponder memory
- Select "Program Transponder"
- To read out the transponder, click on the "Read" button in the index "Read" to show transponder code

4.1.4 Using the TK5561 Read/Write/ Crypto Transponder

4.1.5 Using the U9280M Read/Write/ Crypto

- Select transponder type → Setup...Transponder...U9280M
- Place the transponder sample close to the base-station antenna (consider axial alignment)
- The configuration is fixed. It can only be changed by programming through the interface.
- Choose the index "Write" to program blocks 1...4 of the transponder memory
- Choose "Program Transponder"

- For reading choose "Read" button in the index "Read" to show transponder code
- For starting the encryption process, choose the index "Authentication" to program blocks 5...8 of the transponder memory
- Choose "Program Transponder"
- Choose "Start Authentication" for encryption process

4.1.6 Exit the Program

- Choose the "Exit" command in the main menu

5 Description of the RFID Application Kit Software IDS 5



5.2 Start Window

The menu bar of the application software contains five menus. These are: *Setup*, *Option*, *Application*, *Exit*, *Info*.

5.2.1 Setup

When selecting the submenu “Transponder” in the “setup” menu, the different types of Atmel Wireless & Microcontrollers’ transponders can be seen (figure 6). Depending on the transponder chosen, the user interface will be adjusted.

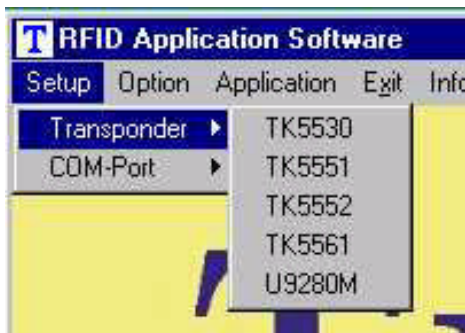

Figure 6. Transponder menu

In the submenu “COM-Port”, select the used RS232 serial port to communicate with the RFID application kit (figure 7). (To check the communication between the PC

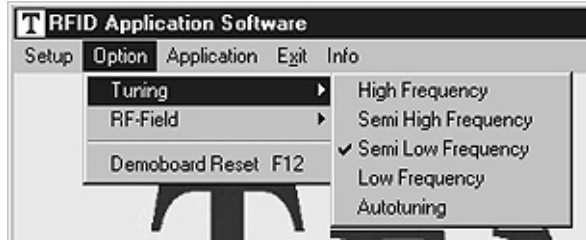

Figure 8. Tuning menu

In manual tuning mode, the user can select one out of four frequency stages from 122 kHz to 128 kHz in steps of 2 kHz (low, semi low, semi high and high). This requires that the on-chip oscillator of the U2270B is tuned to 125 kHz (these values are nominal values, the actual values may slightly differ due to component tolerances). In autotuning mode, the software switches between the four frequencies until the transponder is can be read out. The currently selected frequency stage is indicated on the application board by the Tune 1/2 LEDs binary encoded (figure 9).

0	0	High
0	1	Semi high
1	0	Semi low (default)
1	1	Low

5.2.3 Application

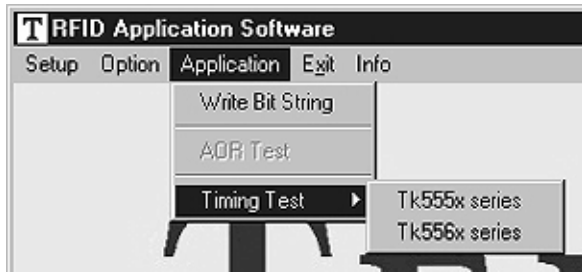

Figure 11. Application menu

The submenu “Application” is for advanced user, to find out optimal adaption of the write timing and the possibility to write bitstrings to the transponder.

5.2.4 Exit

To exit the program, choose this menu.

5.2.5 Info

The submenu “About” in the main menu “Info” shows the actual program version and date.

5.3 TK5530 Read Only Transponder



5.4 TK5551 Read/Write Transponder

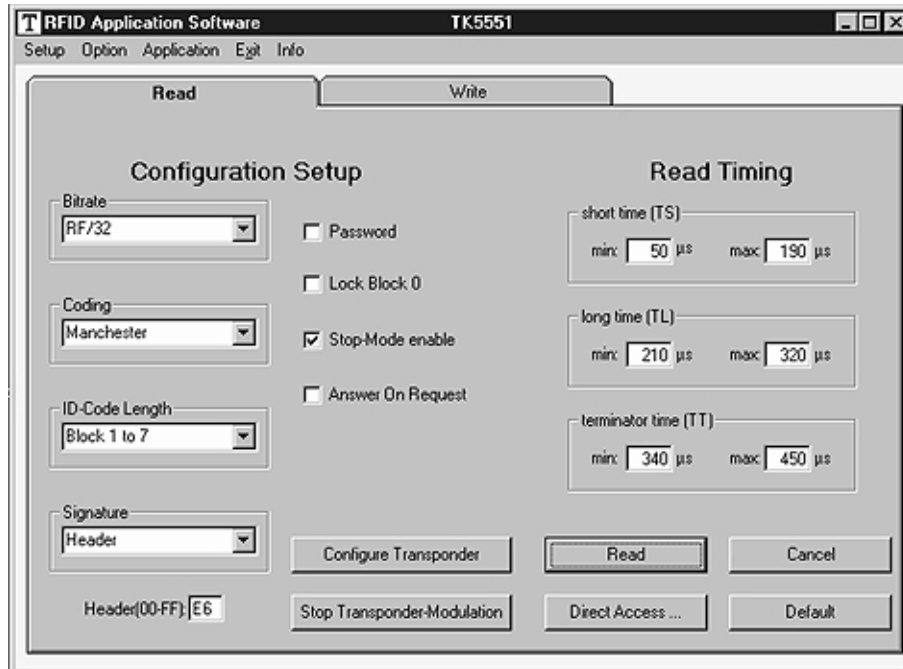

Figure 13. TK5551 read user interface

When the transponder TK5551 is selected, the “Read” index of the TK5551 user interface is shown. This window enables to set the following parameters in the

in such a mode, a warning is displayed. For details, please refer to the e5551 data sheet.

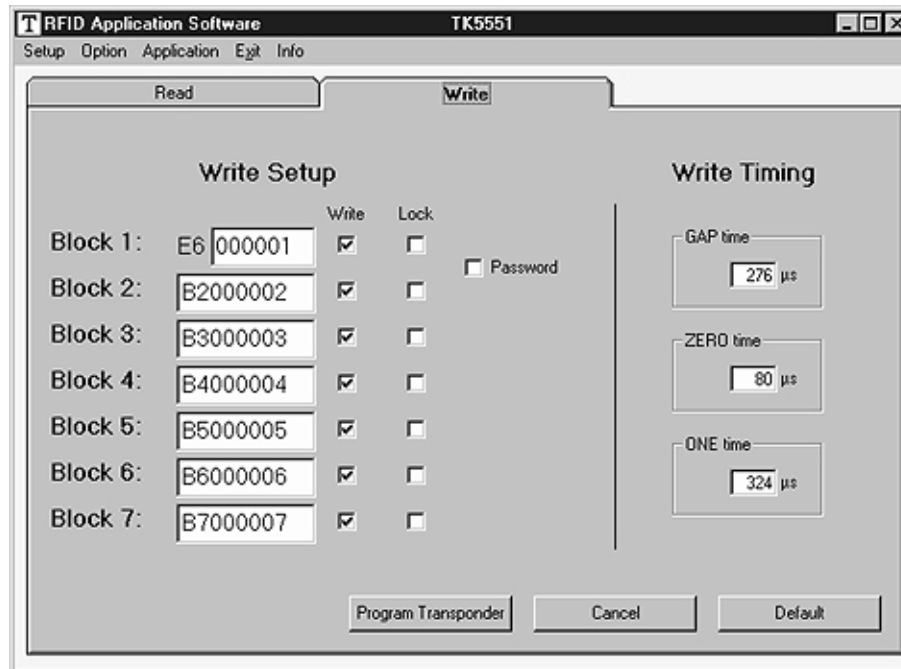

Figure 14. TK5551 write user interface

When selecting to the “Write” index, the write setup and write timing is shown. The first byte in block 1, the header byte, is adjusted in the header text field on the “Read”

The programming of the transponder is performed by the button “**Program Transponder**”. The data for each block is entered using hexadecimal code (characters 0...9

5.4.1 Answer On Request

This feature is used to address the individual transponder when several transponders are in the field. A transponder with activated AOR feature remains silent (no modulation) when an RF field is applied. When the AOR wake-up sequence has been transmitted, the transponder starts transmitting in ID mode and remains active until a POR occurs or a stop command is sent. A transponder that has been activated by an AOR sequence operates like a transponder in standard read mode. The AOR feature is only useful in combination with the password mode. Without password, all transponders start modulation after each AOR wake-up sequence.

Warning: If the transponder has once been configured to AOR mode, the user needs to know correct AOR wake-up sequence (password / block 7) to read out the transponder's code. To change the transponder's configuration (e.g., to deactivate AOR mode), the password is also required. During system design, use this feature with care !

To configure AOR mode, follow the description below:

1. Activate password and Answer On Request in the configuration setup on the "Read" index.

2. Type in a unique password (hexadecimal code) into the password text field.
3. Change to the "Write" index, select the password box in the write column and click on the "Program Transponder" button.
4. Then click on the "Configure Transponder" button in the "Read" index.
5. The transponder is now in AOR and password mode.

This way, each transponder can be set to AOR mode. When all transponders are configured, put them into the RF field. To read out the transponder, follow the description below.

1. Type in the password for a specific transponder into the password text field.
2. Click on the "AOR wake up" button to activate the specific transponder.
3. Read out the transponder by using the "Read" button.
4. To stop the read function, use the "Stop Transponder-Modulation" button.
5. Repeat the procedure 1-4 by using the next password.

5.5 TK5552 Read/Write Transponder

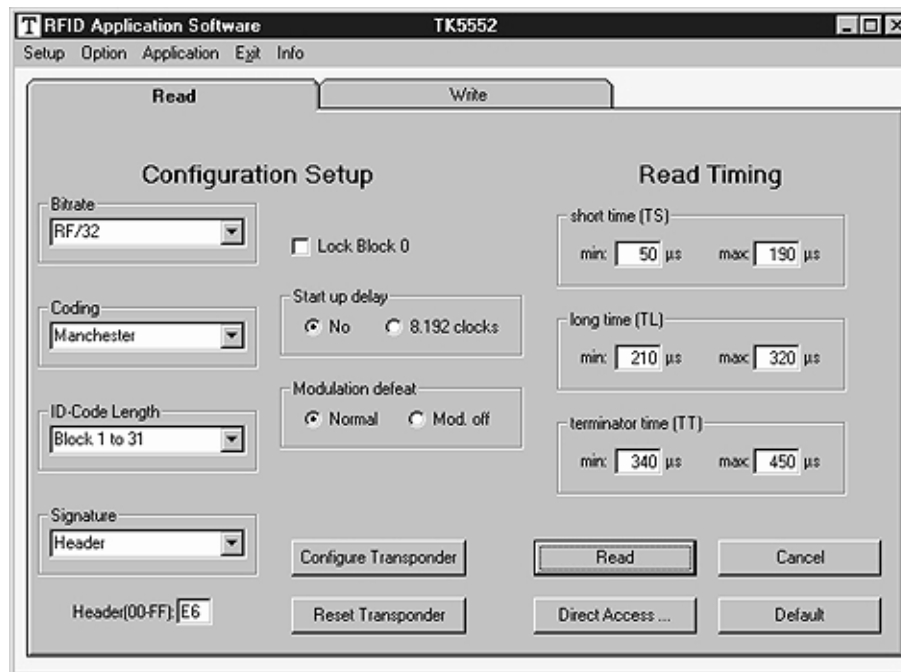

Figure 15. TK5552 read user interface

When the transponder TK5552 is selected, the “Read” index of the TK5552 user interface is shown. This page enables to set the following parameters in the “Configura-

ured in such a mode, a warning is displayed. For details, please refer to the e5552 data sheet in the TK5552 appendix

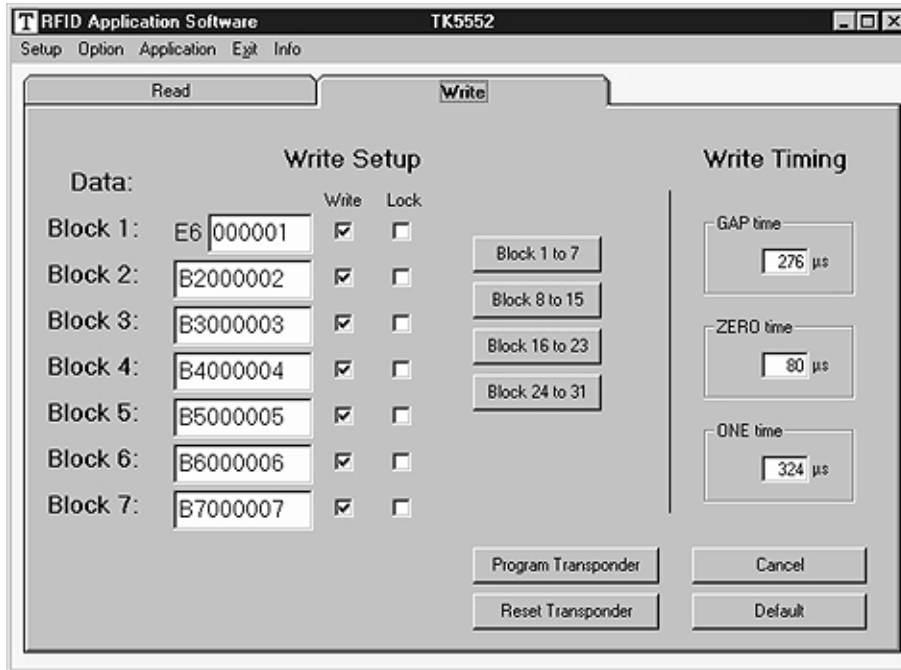

Figure 16. TK5552 write user interface

When changing to the “Write” index, the write setup and write timing is shown. With the buttons “**Block 1 to 7**”, “**Block 8 to 15**”, “**Block 16 to 23**” and “**Block 24 to 31**”,

block is entered using hexadecimal code (characters 0...9 and A...F). The blocks to be programmed are selected by ticking the box in the write column. To protect the data

5.6 TK5561 Read/Write/Crypto Transponder

When the transponder TK5561 is selected, the “Read” index of the TK5561 user interface is shown. This sheet enables to set the following parameters in the “Configuration Setup” (on the left hand):

- Bitrate: Rf/32 and Rf/64
- Coding: Manchester and Biphas
- ID-Code Length: 64 or 128 bit
- Signature: Header, Terminator 1 and Terminator 2
- Password: activates password mode
- Stop-Mode enable: obey stop command
- Lock Block 0:
Setting this bit locks the configuration block of the transponder. This means, the bitrate, Coding, ...etc. are fixed and can not be changed anymore. Please use this feature with care !
- AUT64 rounds: number of AUT64-times
- auto adapt: automatic(ON) or user-programmed adapt bit setting(OFF)

Note: The U2270B is not able to read all bit rates and coding types displayed. If a transponder shall be config-

ured in such a mode, a warning is displayed. For details, please refer to the e5561 data sheet.

To change the configuration setup, press the “**Configure Transponder**” button to program the configuration block of the transponder. (The transponder should be placed close to the application board antenna.)

By means of the “Read Timing” on the righthand side, the timing parameters for the decoding can be set. Under normal operating conditions, the default values can be used.

To read out the transponder, use the “**Read**” button. The decoding principle, in simple terms, is to send the chosen Configuration and Read Timing to the microcontroller on the RFID application kit. In a real-time analysis, the incoming data stream is decoded to binary values and then sent to the PC. Clicking on the button “**Default**” enables a default setting. With the “**Stop Transponder-Modulation**” button, the stop command is sent to the transponder. (This defeats modulation until POR.) To leave the TK5561 user interface, click on the “**Cancel**” button. Choosing the “**Direct Access...**” button, blockwise reading is possible.

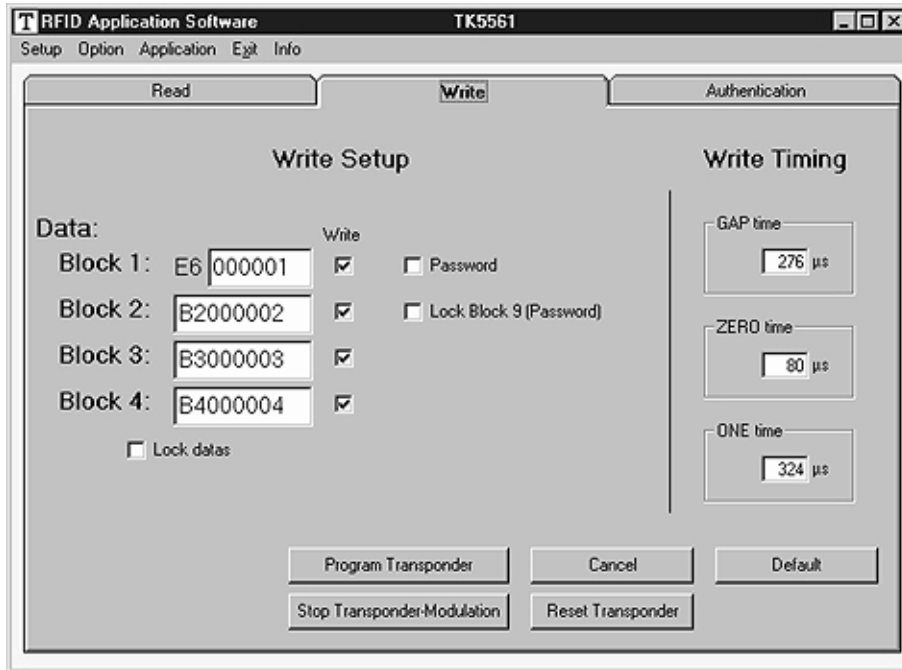

Figure 18. TK5561 write user interface

When changing to the “Write” index, the write setup and write timing is shown. The first byte in block 1, the header byte, is adjusted in the header text field on the “Read”

The programming of the transponder is performed by the button “Program Transponder”. The blocks to be programmed are selected by ticking the box in the write

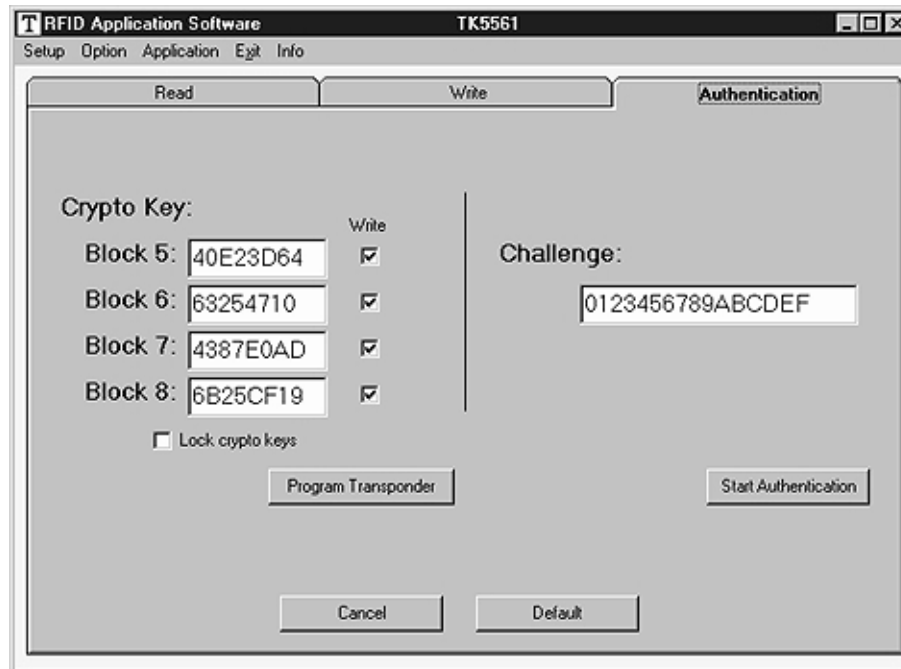

Figure 19. TK5561 authentication user interface

When changing to the “Authentication” index, the crypto keys and challenge are shown. The password box is the same like in the configuration setup. The crypto keys

5.6.1 Authentication

The RFID application kit can be used to demonstrate the encryption feature of the TK5561 read/write/crypto

5.7 U9280M Microcontroller with Transponder Interface

The transponder board is equipped with a standard U9280M-036 ROM mask version.

The U9280M-036 emulates the basic functions of the RFID transponder TK5561 combined with keyless entry functionality.

When the transponder U9280M is selected, the **"Read"** index user interface is displayed. This sheet shows the parameters of the "Fixed Configuration" (on the left hand):

_ Bitrate:	Rf/32
_ Coding:	Manchester
_ ID-Code	Length: 128 bit
_ Signature:	Terminator 1
_ AUT64 rounds:	24 times

This configuration can not be changed by a base station setup command! Parameters can be changed by execution of special interface programming.

By means of the "Read Timing" on the righthand side, the timing parameters for the decoding can be set. Under normal operating conditions, the default values can be used. To read out the transponder, use the **"Read"** button. The decoding principle, in simple terms, is to send the Fixed Configuration and Read Timing to the microcontroller on the RFID application kit. In a real-time analysis, the incoming data stream is decoded to binary values and then sent to the PC.

Clicking on the button **"Default"** enables a default setting.

With the **"Stop Transponder-Modulation"** button, the stop command is sent to the transponder (this defeats modulation until POR).

To leave the U9280M user interface, click on the **"Cancel"** button.



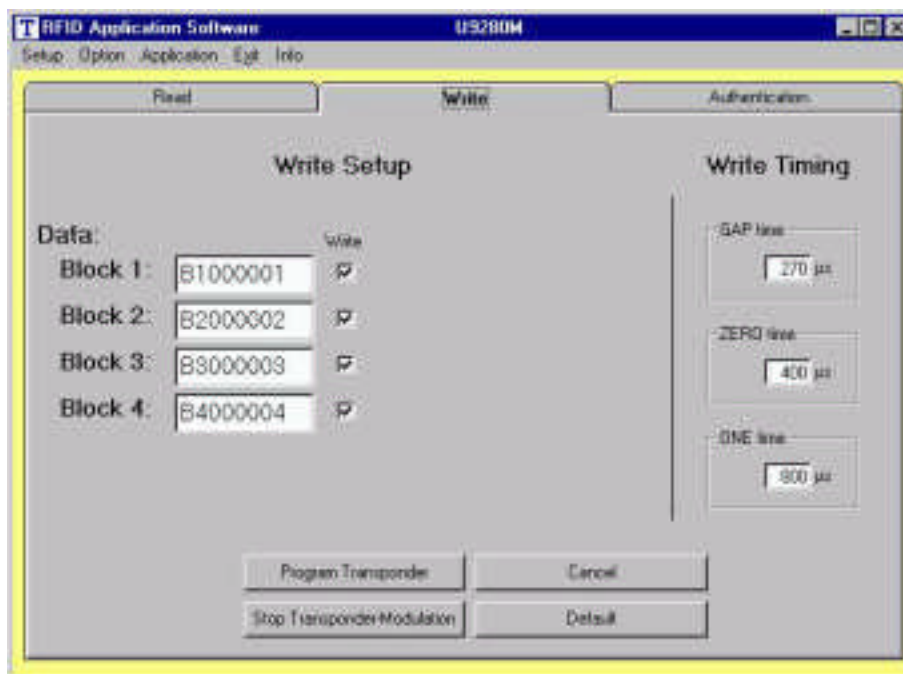

Figure 21. U9280M write interface

When changing to the "Write" index, the write setup and write timing is shown.

By means of the "Write Timing" on the righthand side, the

box in the write column.

Clicking the button "**Default**" enables a default setting.

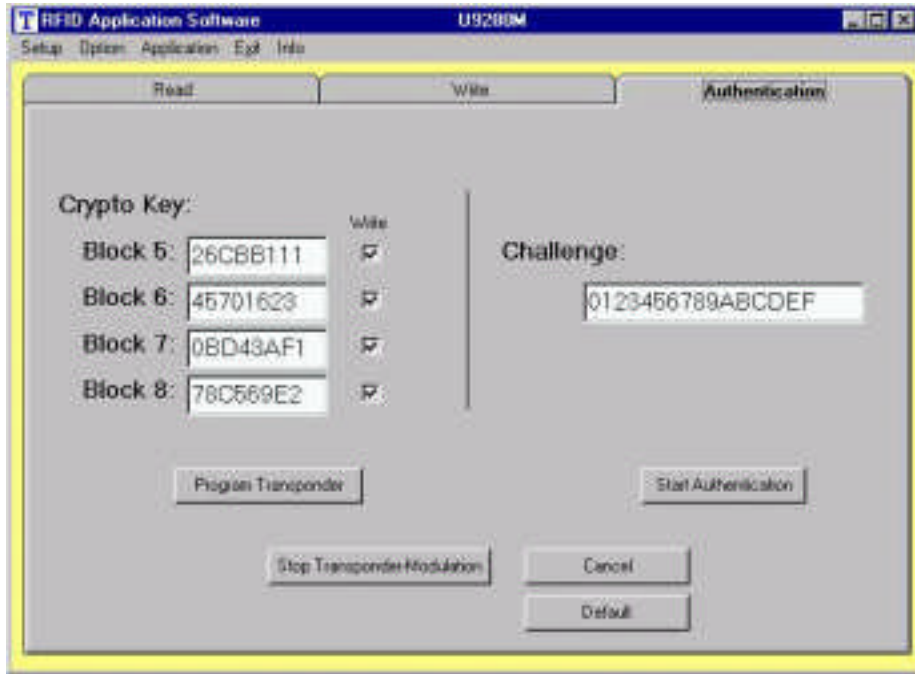

Figure 22. U9280M authentication user interface

5.7.1 Authentication

The RFID application kit can be used to demonstrate the encryption feature of the U9280M read/write/crypto

button "Start Authentication". The check sum result and encryption response of the AUT64 are displayed in a message separated for transponder and base station. If both