

MA2J116 (MA116)

Silicon epitaxial planar type

For general purpose

■ Features

- Small S-mini type package, allowing high-density mounting
- Soft recovery characteristic ($t_{rr} = 100$ ns)

■ Absolute Maximum Ratings $T_a = 25^\circ\text{C}$

Parameter	Symbol	Rating	Unit
Reverse voltage (DC)	V_R	40	V
Peak reverse voltage	V_{RM}	40	V
Average forward current	$I_{F(AV)}$	100	mA
Peak forward current	I_{FM}	225	mA
Non-repetitive peak forward surge current*	I_{FSM}	500	mA
Junction temperature	T_j	150	$^\circ\text{C}$
Storage temperature	T_{stg}	-55 to +150	$^\circ\text{C}$

Noe) * : $t = 1$ s

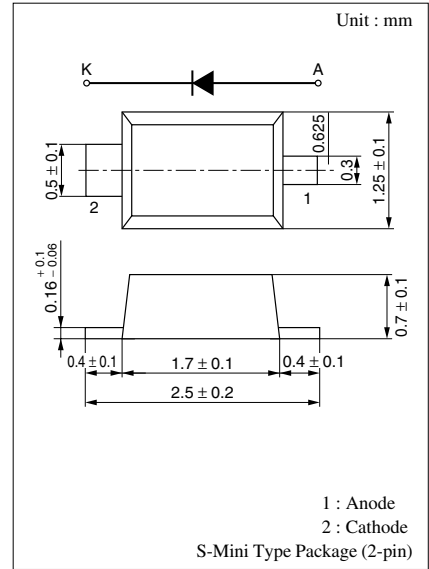

Marking Symbol: 1H

■ Electrical Characteristics $T_a = 25^\circ\text{C}$

Parameter	Symbol	Conditions	Min	Typ	Max	Unit
Reverse current (DC)	I_{R1}	$V_R = 15$ V			5	nA
	I_{R2}	$V_R = 40$ V			10	nA
	I_{R3}	$V_R = 35$ V, $T_a = 100^\circ\text{C}$			100	μA
Forward voltage (DC)	V_F	$I_F = 100$ mA			1.2	V
Reverse voltage (DC)	V_R	$I_R = 100$ μA	35			V
Terminal capacitance	C_t	$V_R = 6$ V, $f = 1$ MHz		1.0	2.0	pF
Forward dynamic resistance*1	r_f	$I_F = 3$ mA, $f = 30$ MHz			3.6	Ω
Reverse recovery time*2	t_{rr}	$I_F = 10$ mA, $V_R = 6$ V $I_{tr} = 0.1 \cdot I_R$, $R_L = 100$ Ω			100	ns

Note) 1. Rated input/output frequency: 100 MHz

2. *1 : YHP 4191A PF IMPEDANCE ANALYZER

*2 : t_{rr} measuring circuit

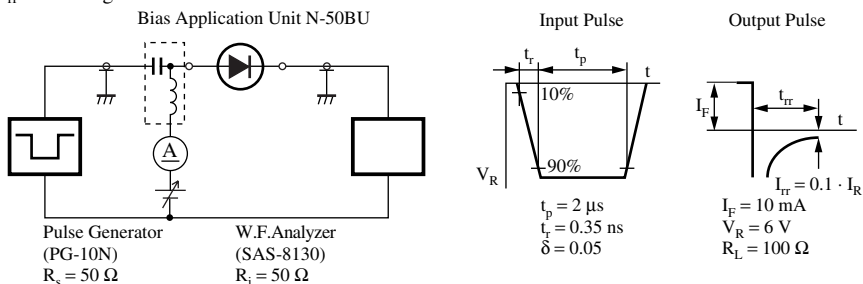

Note) The part number in the parenthesis shows conventional part number.

$I_F - V_F$

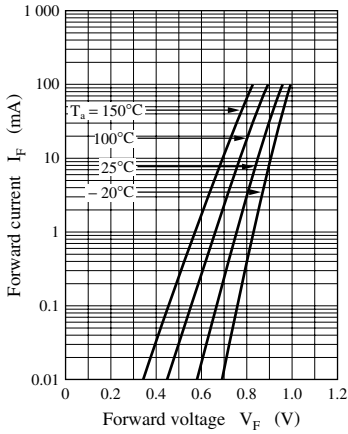

$I_R - V_R$

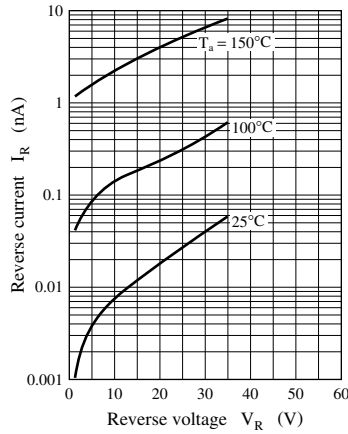

$V_F - T_a$

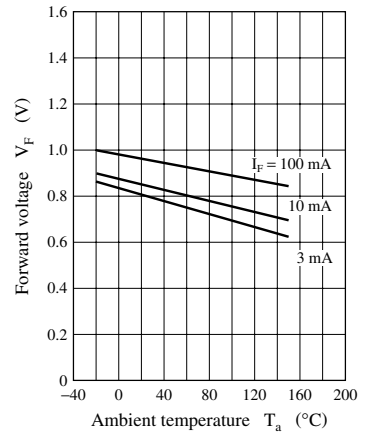

$I_R - T_a$

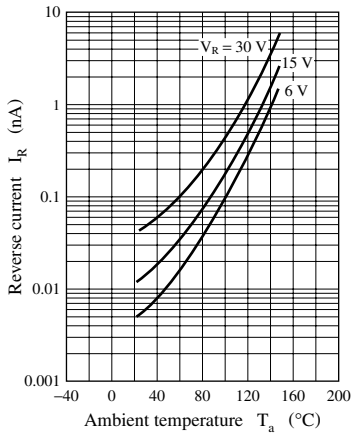

$C_t - V_R$

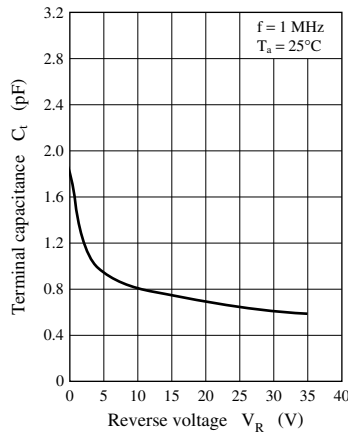

Request for your special attention and precautions in using the technical information and semiconductors described in this material

- (1) An export permit needs to be obtained from the competent authorities of the Japanese Government if any of the products or technologies described in this material and controlled under the "Foreign Exchange and Foreign Trade Law" is to be exported or taken out of Japan.
- (2) The technical information described in this material is limited to showing representative characteristics and applied circuit examples of the products. It does not constitute the warranting of industrial property, the granting of relative rights, or the granting of any license.
- (3) The products described in this material are intended to be used for standard applications or general electronic equipment (such as office equipment, communications equipment, measuring instruments and household appliances).
Consult our sales staff in advance for information on the following applications:
 - Special applications (such as for airplanes, aerospace, automobiles, traffic control equipment, combustion equipment, life support systems and safety devices) in which exceptional quality and reliability are required, or if the failure or malfunction of the products may directly jeopardize life or harm the human body.
 - Any applications other than the standard applications intended.
- (4) The products and product specifications described in this material are subject to change without notice for reasons of modification and/or improvement. At the final stage of your design, purchasing, or use of the products, therefore, ask for the most up-to-date Product Standards in advance to make sure that the latest specifications satisfy your requirements.
- (5) When designing your equipment, comply with the guaranteed values, in particular those of maximum rating, the range of operating power supply voltage and heat radiation characteristics. Otherwise, we will not be liable for any defect which may arise later in your equipment.
Even when the products are used within the guaranteed values, redundant design is recommended, so that such equipment may not violate relevant laws or regulations because of the function of our products.
- (6) When using products for which dry packing is required, observe the conditions (including shelf life and after-unpacking standby time) agreed upon when specification sheets are individually exchanged.
- (7) No part of this material may be reprinted or reproduced by any means without written permission from our company.

Please read the following notes before using the datasheets

- A. These materials are intended as a reference to assist customers with the selection of Panasonic semiconductor products best suited to their applications.
Due to modification or other reasons, any information contained in this material, such as available product types, technical data, and so on, is subject to change without notice.
Customers are advised to contact our semiconductor sales office and obtain the latest information before starting precise technical research and/or purchasing activities.
- B. Panasonic is endeavoring to continually improve the quality and reliability of these materials but there is always the possibility that further rectifications will be required in the future. Therefore, Panasonic will not assume any liability for any damages arising from any errors etc. that may appear in this material.
- C. These materials are solely intended for a customer's individual use.
Therefore, without the prior written approval of Panasonic, any other use such as reproducing, selling, or distributing this material to a third party, via the Internet or in any other way, is prohibited.