

# MegaMOS™ FET

**IXTH 20N60**  
**IXTM 20N60**

**$V_{DSS} = 600\text{ V}$**   
 **$I_{D25} = 20\text{ A}$**   
 **$R_{DS(on)} = 0.35\ \Omega$**

## N-Channel Enhancement Mode

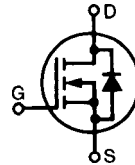

Symbol	Test Conditions	Maximum Ratings	
$V_{DSS}$	$T_J = 25^\circ\text{C}$ to $150^\circ\text{C}$	600	V
$V_{DGR}$	$T_J = 25^\circ\text{C}$ to $150^\circ\text{C}$ ; $R_{GS} = 1\text{ M}\Omega$	600	V
$V_{GS}$	Continuous	$\pm 20$	V
$V_{GSM}$	Transient	$\pm 30$	V
$I_{D25}$	$T_C = 25^\circ\text{C}$	15N60	15 A
		20N60	20 A
$I_{DM}$	$T_C = 25^\circ\text{C}$ , pulse width limited by $T_{JM}$	15N60	60 A
		20N60	80 A
$P_D$	$T_C = 25^\circ\text{C}$	300	W
$T_J$		-55 ... +150	$^\circ\text{C}$
$T_{JM}$		150	$^\circ\text{C}$
$T_{stg}$		-55 ... +150	$^\circ\text{C}$
$M_d$	Mounting torque	1.13/10	Nm/lb.in.
<b>Weight</b>		TO-204 = 18 g, TO-247 = 6 g	
Maximum lead temperature for soldering 1.6 mm (0.062 in.) from case for 10 s		300	$^\circ\text{C}$

TO-247 AD (IXTH)

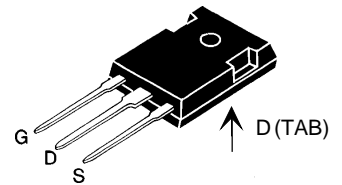

TO-204 AE (IXTM)

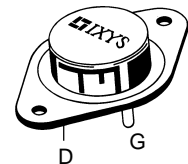

G = Gate, D = Drain,  
S = Source, TAB = Drain

### Features

- International standard packages
- Low  $R_{DS(on)}$  HDMOS™ process
- Rugged polysilicon gate cell structure
- Low package inductance (< 5 nH)
  - easy to drive and to protect
- Fast switching times

### Applications

- Switch-mode and resonant-mode power supplies
- Motor control
- Uninterruptible Power Supplies (UPS)
- DC choppers

### Advantages

- Easy to mount with 1 screw (TO-247) (isolated mounting screw hole)
- Space savings
- High power density

Symbol	Test Conditions	Characteristic Values ( $T_J = 25^\circ\text{C}$ , unless otherwise specified)		
		min.	typ.	max.
$V_{DSS}$	$V_{GS} = 0\text{ V}$ , $I_D = 250\ \mu\text{A}$	600		V
$V_{GS(th)}$	$V_{DS} = V_{GS}$ , $I_D = 250\ \mu\text{A}$	2		4.5 V
$I_{GSS}$	$V_{GS} = \pm 20\text{ V}_{DC}$ , $V_{DS} = 0$			$\pm 100\text{ nA}$
$I_{DSS}$	$V_{DS} = 0.8 \cdot V_{DSS}$ $V_{GS} = 0\text{ V}$	$T_J = 25^\circ\text{C}$		200 $\mu\text{A}$
		$T_J = 125^\circ\text{C}$		1 mA
$R_{DS(on)}$	$V_{GS} = 10\text{ V}$ , $I_D = 0.5\ I_{D25}$ Pulse test, $t \leq 300\ \mu\text{s}$ , duty cycle $d \leq 2\%$			0.35 $\Omega$

Symbol	Test Conditions	Characteristic Values ( $T_J = 25^\circ\text{C}$ , unless otherwise specified)			
		min.	typ.	max.	
$g_{fs}$	$V_{DS} = 10\text{ V}; I_D = 0.5 \cdot I_{D25}$ , pulse test	11	18	S	
$C_{iss}$	$V_{GS} = 0\text{ V}, V_{DS} = 25\text{ V}, f = 1\text{ MHz}$		4500	pF	
$C_{oss}$			420	pF	
$C_{rss}$			140	pF	
$t_{d(on)}$	$V_{GS} = 10\text{ V}, V_{DS} = 0.5 \cdot V_{DSS}, I_D = 0.5 I_{D25}$ $R_G = 2\ \Omega$ , (External)		20	40	ns
$t_r$			43	60	ns
$t_{d(off)}$			70	90	ns
$t_f$			40	60	ns
$Q_{g(on)}$	$V_{GS} = 10\text{ V}, V_{DS} = 0.5 \cdot V_{DSS}, I_D = 0.5 I_{D25}$		150	170	nC
$Q_{gs}$			29	40	nC
$Q_{gd}$			60	85	nC
$R_{thJC}$			0.42	K/W	
$R_{thCK}$		0.25		K/W	

### Source-Drain Diode

Symbol	Test Conditions	Characteristic Values ( $T_J = 25^\circ\text{C}$ , unless otherwise specified)			
		min.	typ.	max.	
$I_S$	$V_{GS} = 0\text{ V}$			20	A
$I_{SM}$	Repetitive;			80	A
$V_{SD}$	$I_F = I_S, V_{GS} = 0\text{ V}$ , Pulse test, $t \leq 300\ \mu\text{s}$ , duty cycle $d \leq 2\%$			1.5	V
$t_{rr}$	$I_F = I_S, -di/dt = 100\text{ A}/\mu\text{s}, V_R = 100\text{ V}$		600		ns

### TO-247 AD (IXTH) Outline

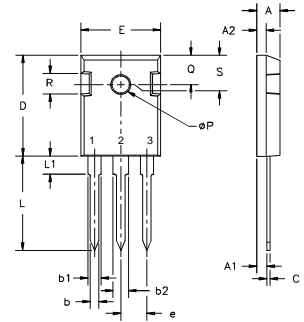

Terminals: 1 - Gate 2 - Drain  
3 - Source Tab - Drain

Dim.	Millimeter		Inches	
	Min.	Max.	Min.	Max.
A	4.7	5.3	.185	.209
A <sub>1</sub>	2.2	2.54	.087	.102
A <sub>2</sub>	2.2	2.6	.059	.098
b	1.0	1.4	.040	.055
b <sub>1</sub>	1.65	2.13	.065	.084
b <sub>2</sub>	2.87	3.12	.113	.123
C	.4	.8	.016	.031
D	20.80	21.46	.819	.845
E	15.75	16.26	.610	.640
e	5.20	5.72	0.205	0.225
L	19.81	20.32	.780	.800
L1		4.50		.177
∅P	3.55	3.65	.140	.144
Q	5.89	6.40	0.232	0.252
R	4.32	5.49	.170	.216
S	6.15	BSC	242	BSC

### TO-204AE (IXTM) Outline

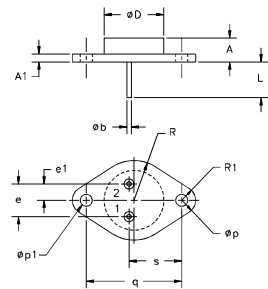

Pins 1 - Gate 2 - Source  
Case - Drain

Dim.	Millimeter		Inches	
	Min.	Max.	Min.	Max.
A	6.4	11.4	.250	.450
A <sub>1</sub>	1.53	3.42	.060	.135
∅b	1.45	1.60	.057	.063
∅D		22.22		.875
e	10.67	11.17	.420	.440
e <sub>1</sub>	5.21	5.71	.205	.225
L	11.18	12.19	.440	.480
∅p	3.84	4.19	.151	.165
∅p <sub>1</sub>	3.84	4.19	.151	.165
q		30.15 BSC		1.187 BSC
R	12.58	13.33	.495	.525
R <sub>1</sub>	3.33	4.77	.131	.188
s	16.64	17.14	.655	.675

Fig. 1 Output Characteristics

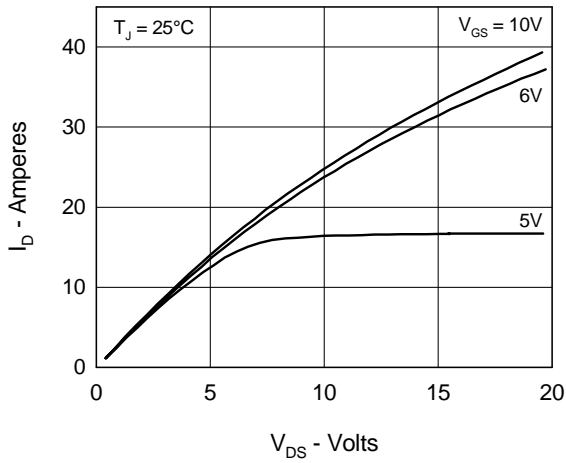

Fig. 2 Input Admittance

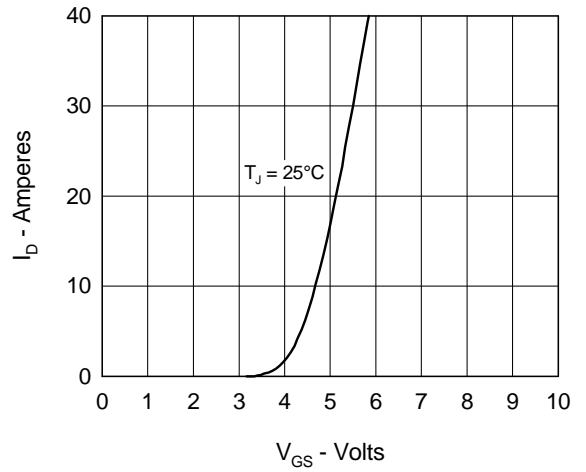

Fig. 3  $R_{DS(on)}$  vs. Drain Current

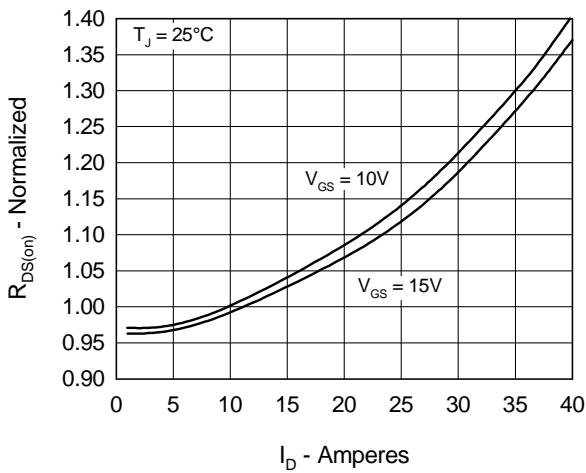

Fig. 4 Temperature Dependence of Drain to Source Resistance

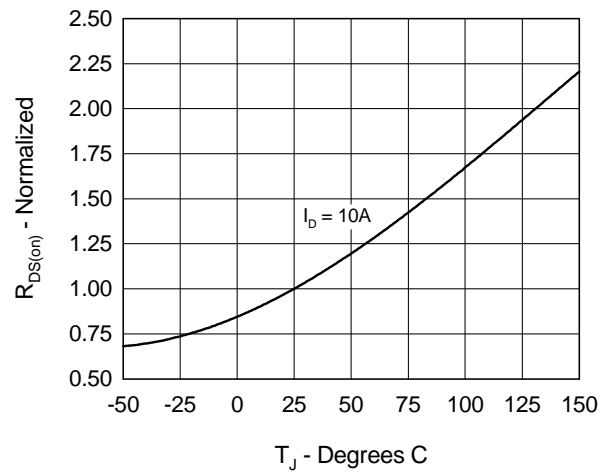

Fig. 5 Drain Current vs. Case Temperature

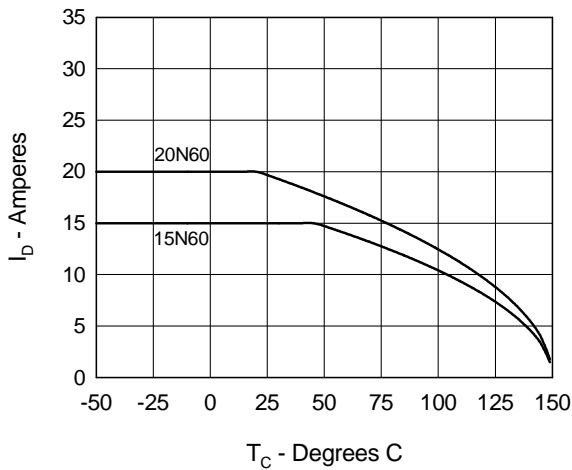
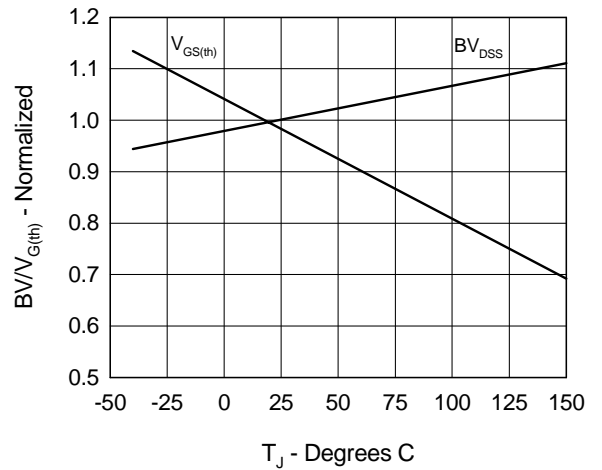
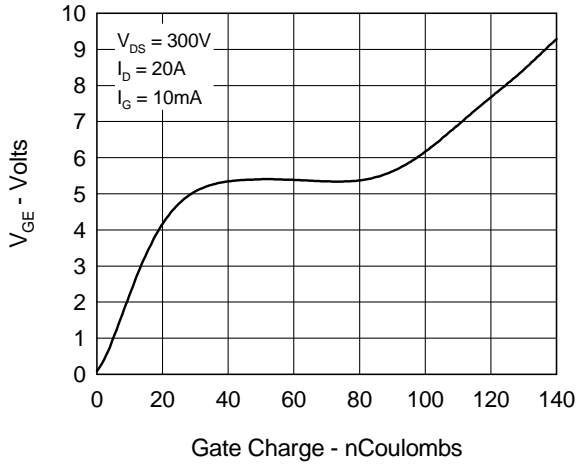

Fig. 6 Temperature Dependence of Breakdown and Threshold Voltage



**Fig.7 Gate Charge Characteristic Curve**



**Fig.8 Forward Bias Safe Operating Area**

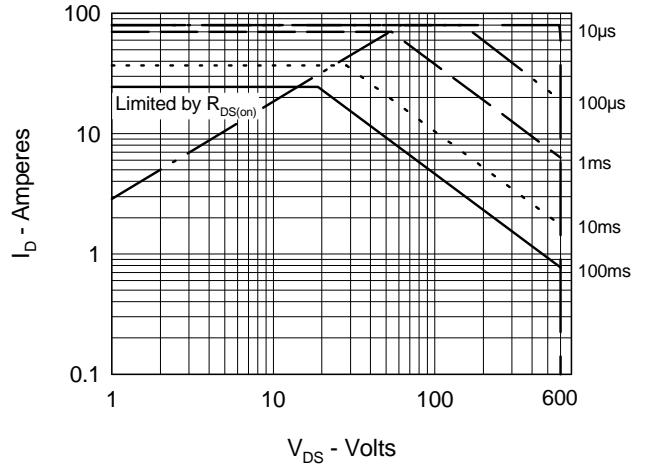

**Fig.9 Capacitance Curves**

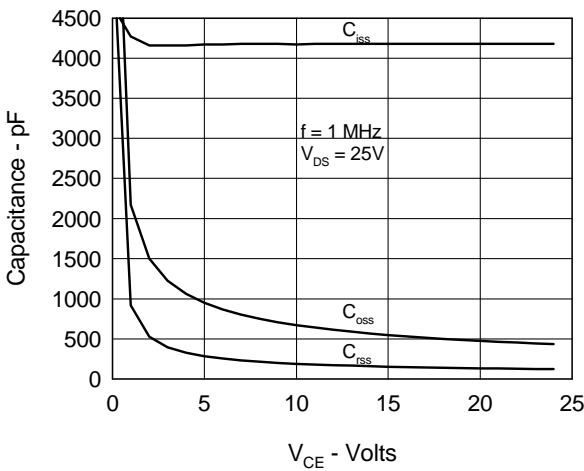

**Fig.10 Source Current vs. Source to Drain Voltage**

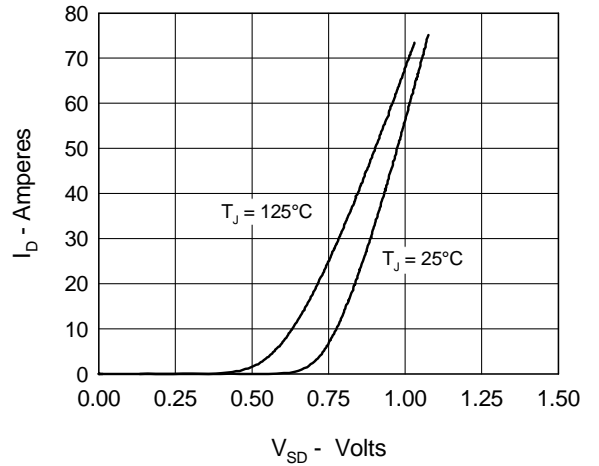

**Fig.11 Transient Thermal Impedance**

