

TOSHIBA TRANSISTOR SILICON NPN EPITAXIAL PLANAR TYPE

2SC3429

VHF ~ UHF BAND LOW NOISE AMPLIFIER APPLICATIONS

Unit in mm

- Low Noise Figure
- $NF = 1.5dB, |S_{21e}|^2 = 16dB (f = 500MHz)$
- $NF = 1.7dB, |S_{21e}|^2 = 10.5dB (f = 1GHz)$

MAXIMUM RATINGS (Ta = 25°C)

CHARACTERISTIC	SYMBOL	RATING	UNIT
Collector-Base Voltage	V _{CBO}	17	V
Collector-Emitter Voltage	V _{CEO}	12	V
Emitter-Base Voltage	V _{EBO}	3	V
Collector Current	I _C	70	mA
Base Current	I _B	30	mA
Collector Power Dissipation	P _C	150	mW
Junction Temperature	T _j	125	°C
Storage Temperature Range	T _{stg}	-55~125	°C

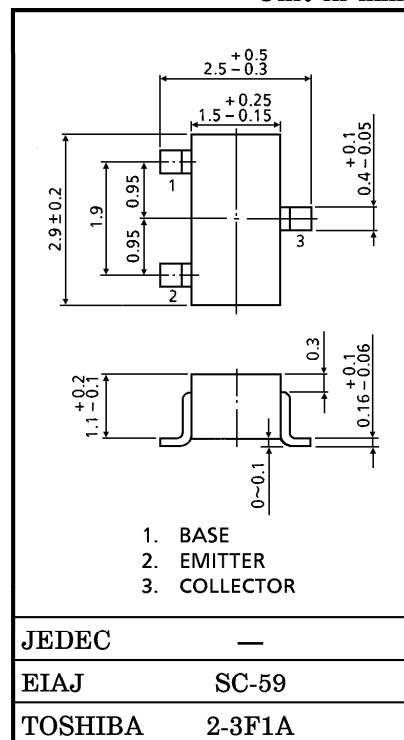

Weight : 0.012g

Marking

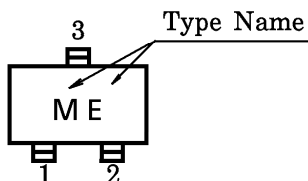

MICROWAVE CHARACTERISTICS (Ta = 25°C)

CHARACTERISTIC	SYMBOL	TEST CONDITION	MIN.	TYP.	MAX.	UNIT
Transition Frequency	f _T	V _{CE} = 10V, I _C = 20mA	—	5	—	GHz
Insertion Gain	S _{21e} ² (1)	V _{CE} = 10V, I _C = 20mA, f = 500MHz	—	16	—	dB
	S _{21e} ² (2)	V _{CE} = 10V, I _C = 20mA, f = 1GHz	—	10.5	—	dB
Noise Figure	NF (1)	V _{CE} = 10V, I _C = 5mA, f = 500MHz	—	1.5	—	dB
	NF (2)	V _{CE} = 10V, I _C = 5mA, f = 1GHz	—	1.7	—	dB

ELECTRICAL CHARACTERISTICS (Ta = 25°C)

CHARACTERISTIC	SYMBOL	TEST CONDITION	MIN.	TYP.	MAX.	UNIT
Collector Cut-off Current	I _{CBO}	V _{CB} = 10V, I _E = 0	—	—	1	μA
Emitter Cut-off Current	I _{EBO}	V _{EB} = 1V, I _C = 0	—	—	1	μA
DC Current Gain	h _{FE}	V _{CE} = 10V, I _C = 20mA	25	—	—	—
Collector Output Capacitance	C _{ob}	V _{CB} = 10V, I _E = 0,	—	0.85	—	pF
Reverse Transfer Capacitance	C _{re}	f = 1MHz (Note)	—	0.57	—	pF

(Note) C_{re} is measured by 3 terminal method with Capacitance Bridge.

961001EAA2

- TOSHIBA is continually working to improve the quality and the reliability of its products. Nevertheless, semiconductor devices in general can malfunction or fail due to their inherent electrical sensitivity and vulnerability to physical stress. It is the responsibility of the buyer, when utilizing TOSHIBA products, to observe standards of safety, and to avoid situations in which a malfunction or failure of a TOSHIBA product could cause loss of human life, bodily injury or damage to property. In developing your designs, please ensure that TOSHIBA products are used within specified operating ranges as set forth in the most recent products specifications. Also, please keep in mind the precautions and conditions set forth in the TOSHIBA Semiconductor Reliability Handbook.
- The information contained herein is presented only as a guide for the applications of our products. No responsibility is assumed by TOSHIBA CORPORATION for any infringements of intellectual property or other rights of the third parties which may result from its use. No license is granted by implication or otherwise under any intellectual property or other rights of TOSHIBA CORPORATION or others.
- The information contained herein is subject to change without notice.

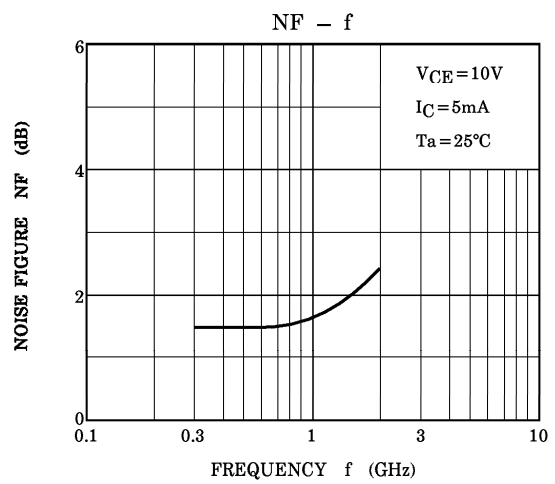
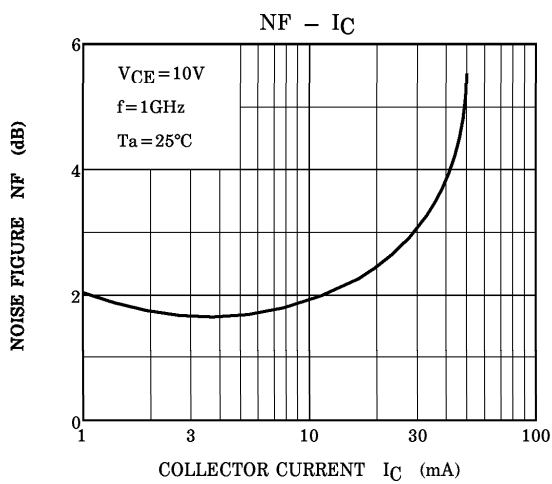
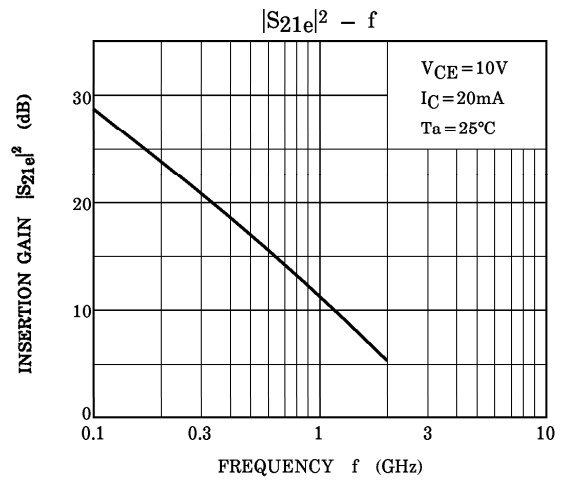
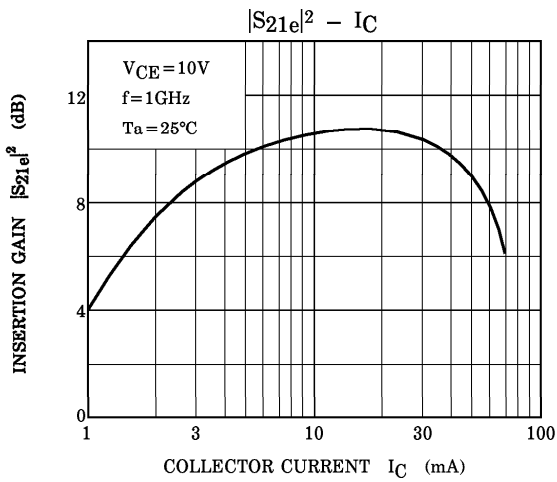
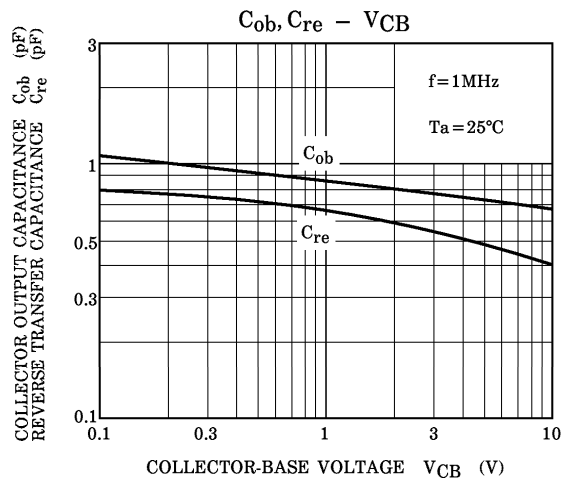
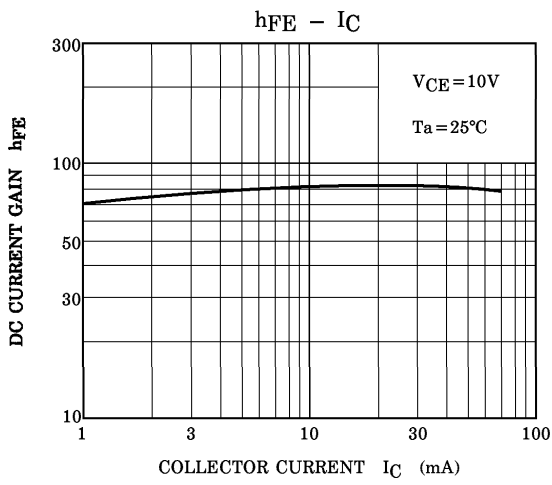

S11e
 VCE = 10V
 IC = 20mA
 Ta = 25°C
 (UNIT : Ω)

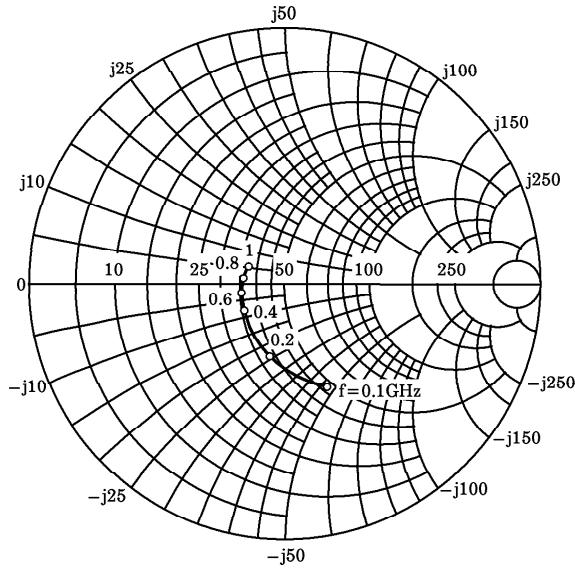

S12e
 VCE = 10V
 IC = 20mA
 Ta = 25°C

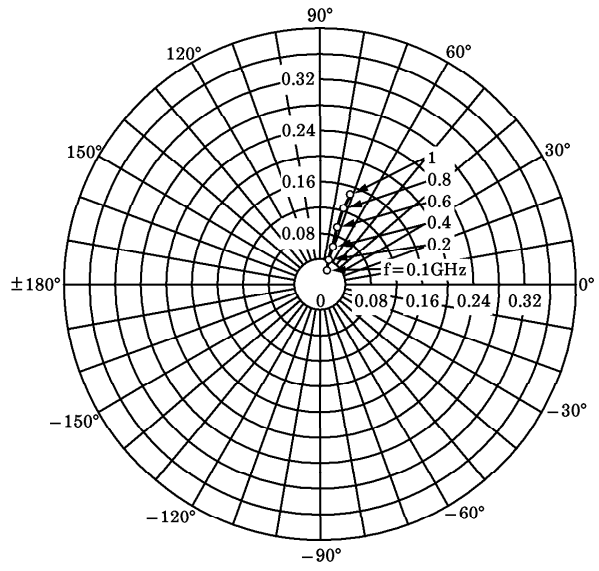

S21e
 VCE = 10V
 IC = 20mA
 Ta = 25°C

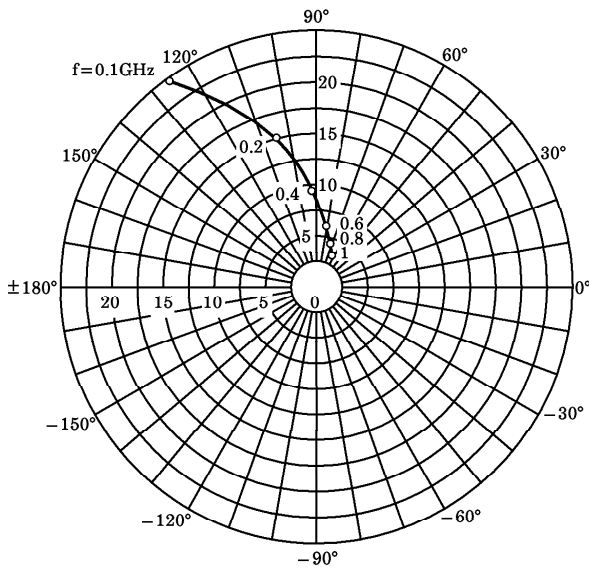

S22e
 VCE = 10V
 IC = 20mA
 Ta = 25°C
 (UNIT : Ω)

