

液晶之友 电话: 020-33819057  
[Http://www.lcdfriends.com](http://www.lcdfriends.com)

# PRODUCT SPECIFICATION

MONOCHROME LCD MODULE

PART NUMBER : FDA1001A

DESCRIPTION : 1x10 Character

REVISION : Rev A

	Approval for Specification only		Approval for Sample Only
	Approval for Pre-production	<b>x</b>	Approval for Mass Production

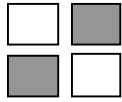

# FDA1001A ( 10 CHARACTERS x 1 LINES )

## FEATURES

- ◆ 5 x 7 DOTS WITH CURSOR
- ◆ BUILT-IN CONTROLLER (KS0066 OR EQUIVALENT)
- ◆ 5 V POWER SUPPLY
- ◆ 1/16 DUTY CYCLE
- ◆ 4.2 V LED FORWARD VOLTAGE

## MECHANICAL DATA

ITEM	DIMENSIONS	UNIT
Module Size ( W x H x T )	80.0 x 36.0 x 8.8 ( 12.7 LED )	mm
Viewing Area ( W x H )	65.0 x 16.0	mm
Character Size ( W x H )	4.84 x 9.22	mm
Character Pitch ( W x H )	6.0 x 9.22	mm
Dot Size ( W x H )	0.92 x 1.1	mm
Dot Pitch ( W x H )	0.98 x 1.16	mm

## INTERFACE PIN CONNECTIONS

NO.	SYMBOL	FUNCTION	NO.	SYMBOL	FUNCTION
1	VSS	Supply Ground	9	DB2	Data Bit 2
2	VDD	Supply Voltage	10	DB3	Data Bit 3
3	Vo	Contrast Adj.	11	DB4	Data Bit 4
4	RS	Register Select	12	DB5	Data Bit 5
5	R/W	Read/Write	13	DB6	Data Bit 6
6	E	Enable Signal	14	DB7	Data Bit 7
7	DB0	Data Bit 0	15	A	LED Power
8	DB1	Data Bit 1	16	K	LED Power

## ELECTRICAL CHARACTERISTICS

ITEM	SYMBOL	CONDITION	MIN.	TYP.	MAX.	UNIT
LCD Operating Voltage	V <sub>DD-Vo</sub>	T=0°C	-	4.8	-	V
		T=25°C	-	4.5	-	V
		T=50°C	-	4.2	-	V
Supply Voltage	V <sub>DD-VSS</sub>	-	4.7	5	5.3	V
Supply Current	I <sub>DD</sub>	-	-	1.2	2.5	mA
Input Voltage	"HIGH" Level	V <sub>IH</sub>	-	2.2	-	V <sub>DD</sub> V
	"LOW" Level	V <sub>IL</sub>	-	0	-	0.6 V
Output Voltage	"HIGH" Level	V <sub>OH</sub>	-	2.4	-	V
	"LOW" Level	V <sub>OL</sub>	-	-	-	0.4 V

## BLOCK DIAGRAM

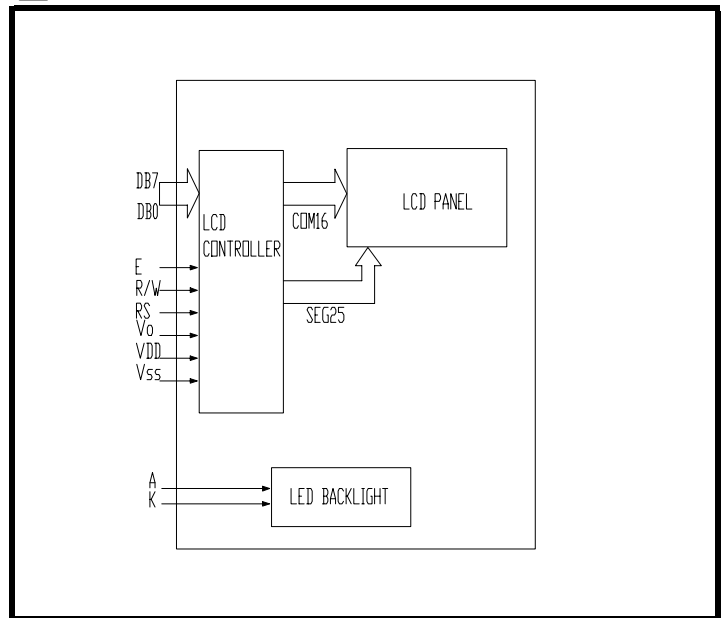

## EXTERNAL DIMENSIONS

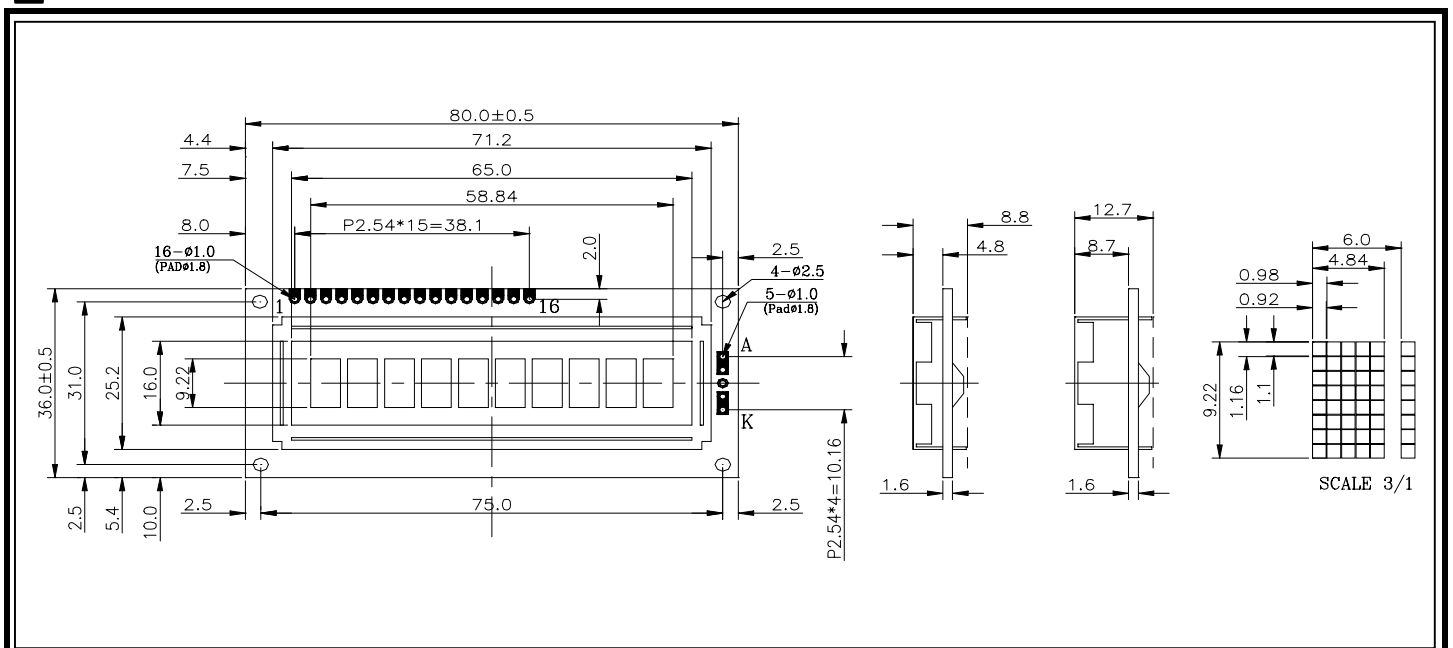

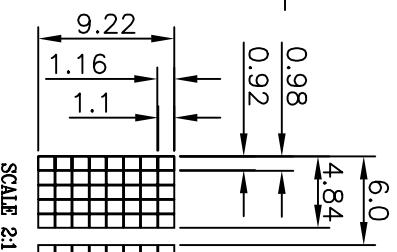
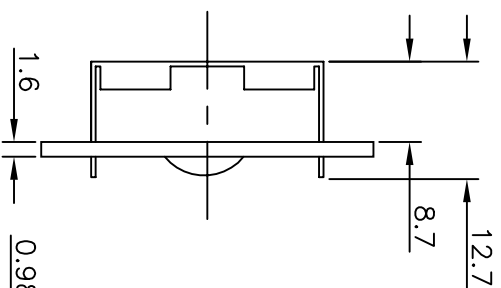
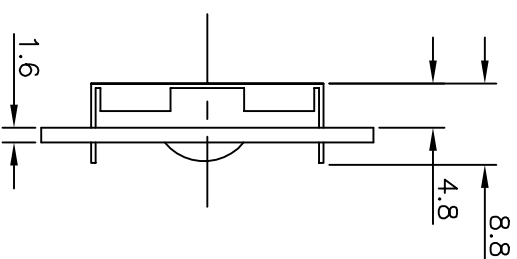
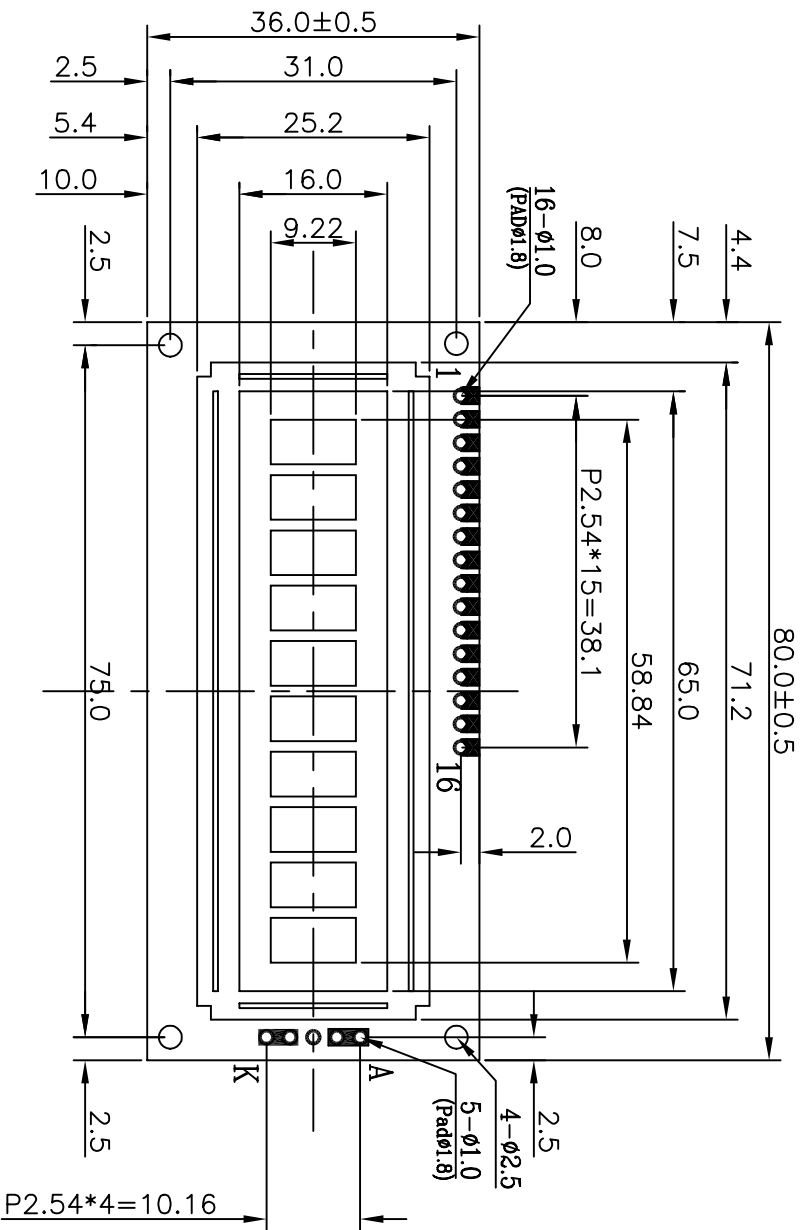

PIN NO	SIGNAL
1	VSS
2	VDD
3	V0
4	RS
5	R/W
6	E
7	DB0
8	DB1
9	DB2
10	DB3
11	DB4
12	DB5
13	DB6
14	DB7
15	A
16	K

NOTE	ITEM	CONTENT	DATA	REV	TOLERANCE	SCALE	UNIT	CHKD	DWYN	DATE	CUSTOMER	APVL	TITLE	MODEL	DWG. NO	PAGE
		CHANGE NUMBER	2004.03.01	0	X. ±0.30 X ±0.20 .XX±0.05	1/1	mm	HSU	Gili	2004.03.01			MODULE	SC1001A	A-A1-0040	1/1
<b>SUNLIKE DISPLAY</b>																