

MIG30J901H

Maximum Ratings (Ta = 25°C)

STAGE		CHARACTERISTIC		SYMBOL	RATINGS	UNIT	
Inverter	Collector-Emitter Voltage			V_{CES}	600	V	
	Gate-Emitter Voltage			V_{GES}	±20	V	
	Collector Current	DC		I_C	30	A	
		1ms		I_{CP}	60		
	Forward Current	DC		I_F	30	A	
		1ms		I_{FM}	60		
Collector Power Dissipation (Tc = 25°C)			P_C	100	W		
Converter	Repetitive Peak Reverse Voltage			V_{RRM}	800	V	
	Average Output Rectified Current			I_O	20	A	
	Peak One Cycle Surge Forward Current (50Hz, Non-Repetitive)			I_{FSM}	250	A	
Brake	IGBT	Collector-Emitter Voltage			V_{CES}	600	V
		Gate-Emitter Voltage			V_{GES}	±20	V
		Collector Current	DC		I_C	15	A
			1ms		I_{CP}	30	
	Collector Power Dissipation (Tc = 25°C)			P_C	65	W	
	FRD	Repetitive Peak Reverse Voltage			V_{RRM}	600	V
		Forward Current	DC		I_F	15	A
			1ms		I_{FM}	30	
Module		Junction Temperature			T_j	150	°C
	Storage Temperature Range			T_{stg}	-40 ~ 125	°C	
	Isolation Voltage			V_{isol}	2500 (AC 1 minute)	V	
	Screw Torque			—	3	N•m	

Electrical Characteristics (Ta = 25°C)

a. Inverter Stage

CHARACTERISTIC		SYMBOL	TEST CONDITION	MIN.	TYP.	MX.	UNIT
Gate Leakage Current		I_{GES}	$V_{GE} = \pm 20V, V_{CE} = 0$	-	-	± 20	μA
Collector Cut-off Current		I_{CES}	$V_{CE} = 600V, V_{GE} = 0$	-	-	1.0	mA
Gate-Emitter Cut-off Voltage		$V_{GE (off)}$	$V_{CE} = 5V, I_C = 30mA$	3.0	-	6.0	V
Collector-Emitter Saturation Voltage		$V_{CE (sat)}$	$I_C = 30A, V_{GE} = 15V$	-	3.0	4.0	V
Input Capacitance		C_{ies}	$V_{CE} = 10V, V_{GE} = 0$ $f = 1MHz$	-	2000	-	pF
Switching Time	Turn-on Delay Time	$t_{d(on)}$	Inductive Load $V_{CC} = 300V$ $I_C = 30A$ $V_{GE} = \pm 15V$ $R_G = 82\Omega$ (Note 1)	-	0.08	0.16	μs
	Rise Time	t_r		-	0.12	0.24	
	Turn-on Time	t_{on}		-	0.40	0.80	
	Turn-off Delay Time	$t_{d(off)}$		-	0.30	0.60	
	Fall Time	t_f		-	0.15	0.30	
	Turn-off Time	t_{off}		-	0.60	1.00	
Forward Voltage		V_F	$I_F = 30A, V_{GE} = 0$	-	1.5	2.3	V
Reverse Recovery Time		t_{rr}	$I_F = 30A, V_{GE} = -10V$ $di/dt = 50A/\mu s$	-	0.08	0.15	μs
Thermal Resistance		$R_{th(j-c)}$	Transistor	-	-	1.25	$^{\circ}C/W$
			Diode	-	-	1.56	

b. Converter Stage

CHARACTERISTIC	SYMBOL	TEST CONDITION	MIN.	TYP.	MX.	UNIT
Repetitive Peak Reverse Current	I_{RRM}	$V_{RRM} = 800V$	-	-	50	μA
Peak Forward Voltage	V_{FM}	$I_{FM} = 20A$	-	1.05	1.20	V
Peak One Cycle Surge Forward Current	I_{FSM}	50Hz Sine-half-wave	250	-	-	A
Thermal Resistance	$R_{th(j-c)}$		-	-	2.50	$^{\circ}C/W$

MIG30J901H

c. Brake Stage

CHARACTERISTIC		SYMBOL	TEST CONDITION	MIN.	TYP.	MX.	UNIT
Gate Leakage Current		I_{GES}	$V_{GE} = \pm 20V, V_{CE} = 0$	-	-	± 20	μA
Collector Cut-off Current		I_{CES}	$V_{CE} = 600V, V_{GE} = 0$	-	-	1.0	mA
Repetitive Peak Reverse Current		I_{RRM}	$V_{RRM} = 600V$	-	-	1.0	mA
Gate-Emitter Cut-off Voltage		$V_{GE(off)}$	$V_{CE} = 5V, I_C = 15mA$	3.0	-	6.0	V
Collector-Emitter Saturation Voltage		$V_{CE(sat)}$	$I_C = 15A, V_{GE} = 15V$	-	3.0	4.0	V
Input Capacitance		C_{ies}	$V_{CE} = 10V, V_{GE} = 0, f = 1MHz$	-	1000	-	pF
Switching Time	Turn-on Delay Time	$t_{d(on)}$	Inductive Load $V_{CC} = 300V$ $I_C = 15A$ $V_{GE} = \pm 15V$ $R_G = 150\Omega$ (Note 1)	-	0.08	0.16	μs
	Rise Time	t_r		-	0.12	0.24	
	Turn-on Time	t_{on}		-	0.40	0.80	
	Turn-off Delay Time	$t_{d(off)}$		-	0.30	0.60	
	Fall Time	t_f		-	0.30	0.55	
	Turn-off Time	t_{off}		-	0.65	1.00	
Forward Voltage		V_F	$I_F = 15A, V_{GE} = 0$	-	1.7	2.5	V
Thermal Resistance		$R_{th(l-c)}$	Transistor	-	-	1.92	$^{\circ}C/W$
			Diode	-	-	2.80	

Note. 1 Switching Time Test Circuit & Timing Chart

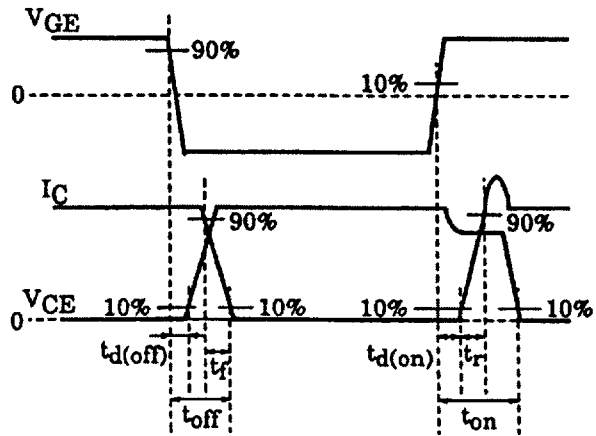
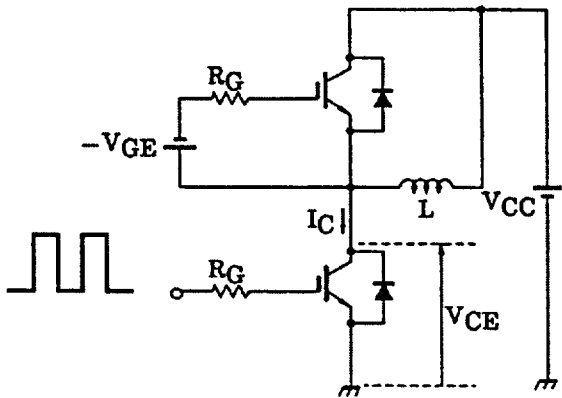

a. Inverter Stage

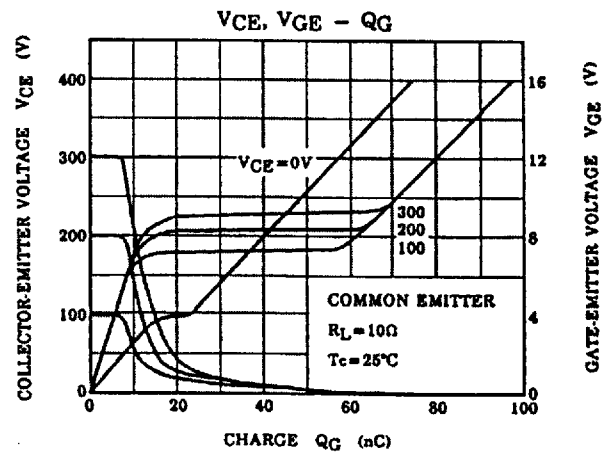
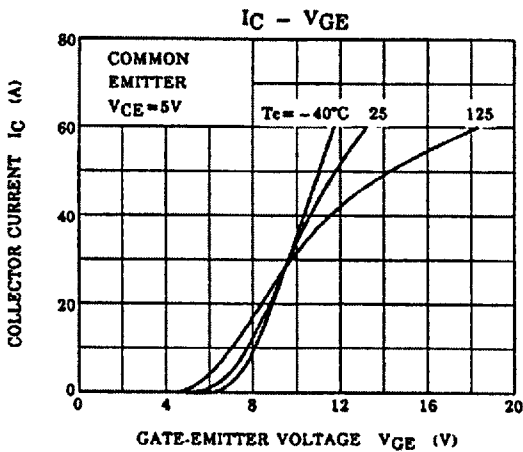
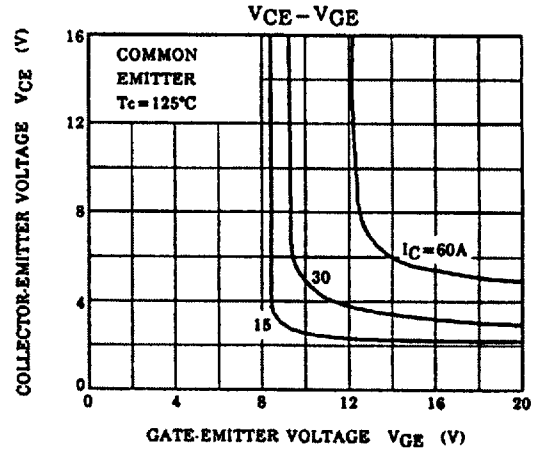
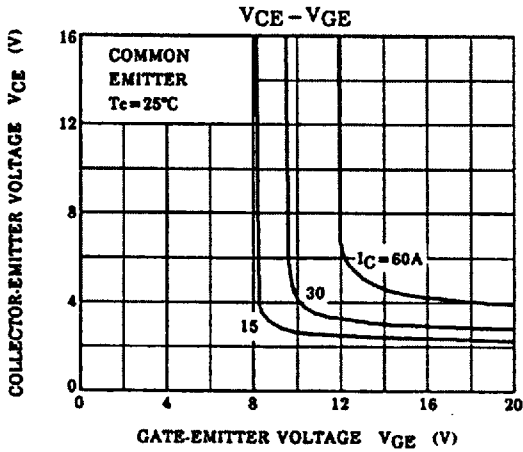
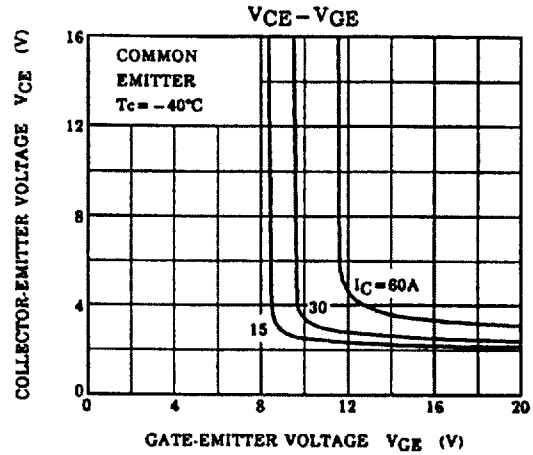
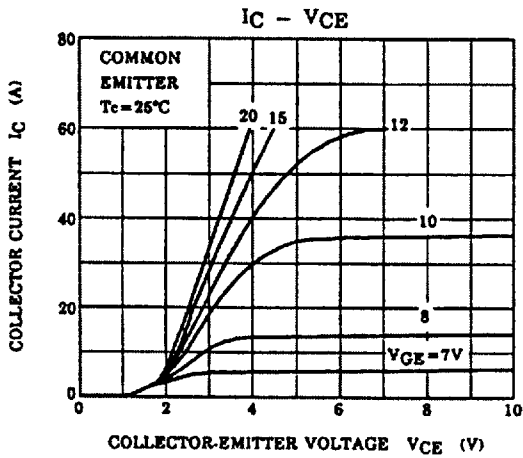

a. Inverter Stage

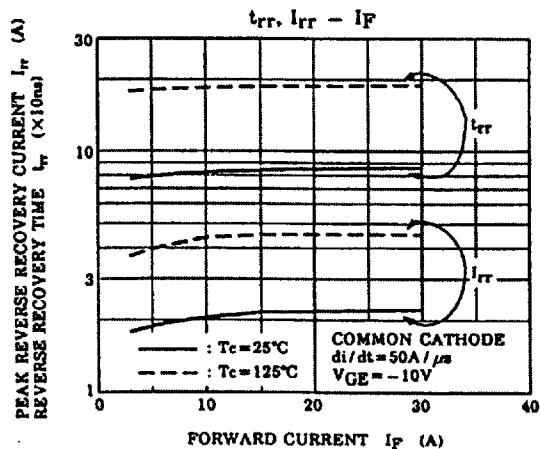
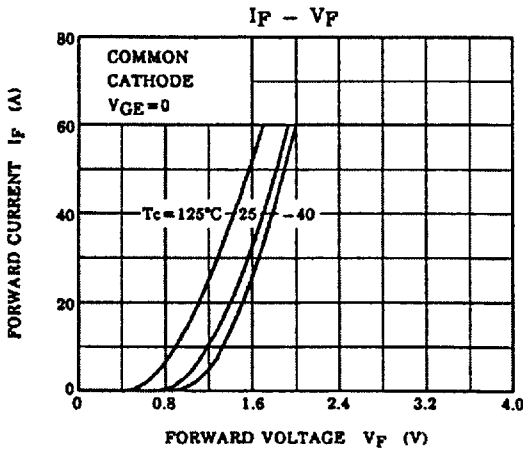
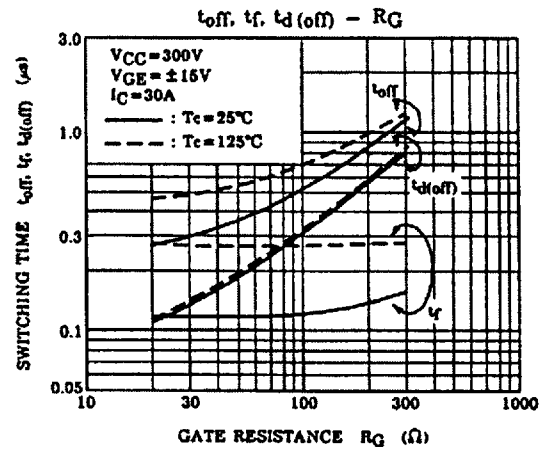
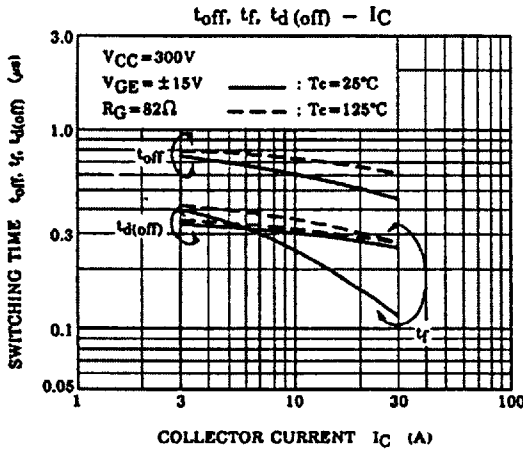
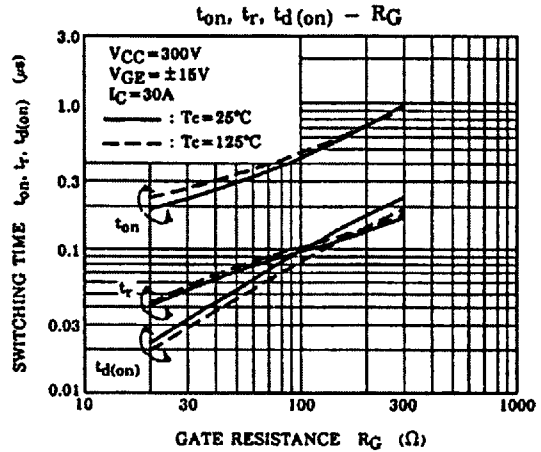
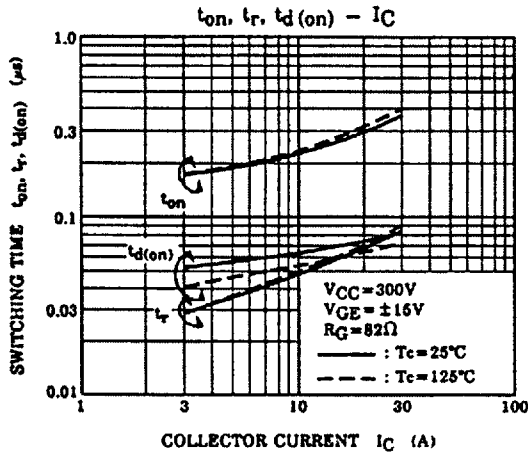

a. Inverter Stage

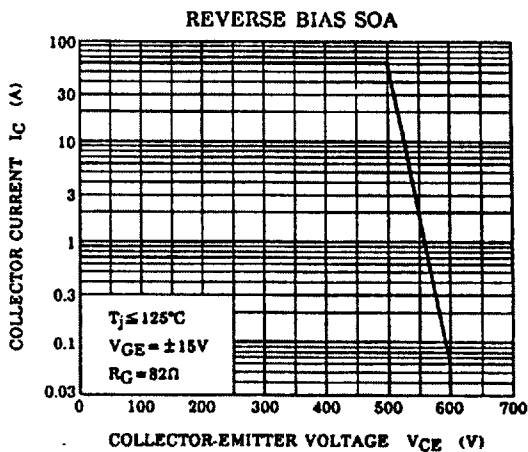
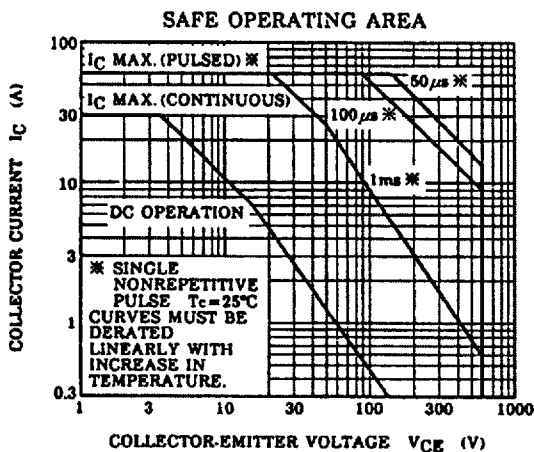
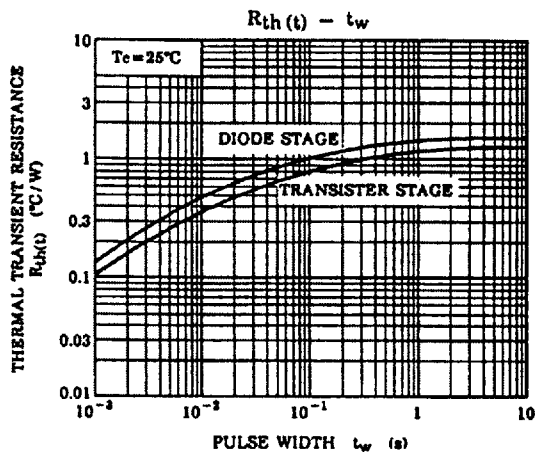
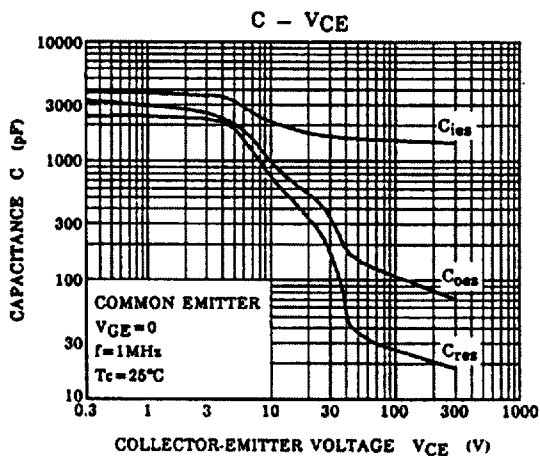

b. Converter Stage

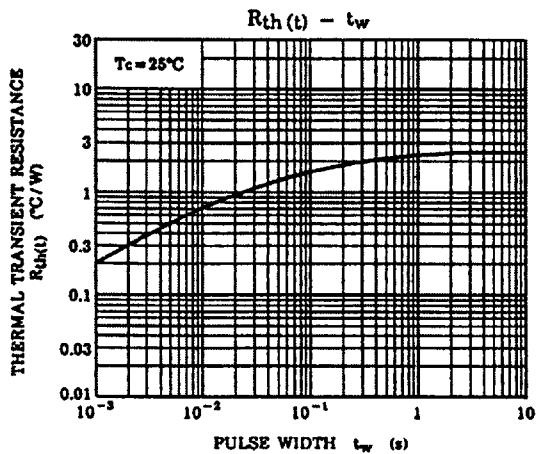
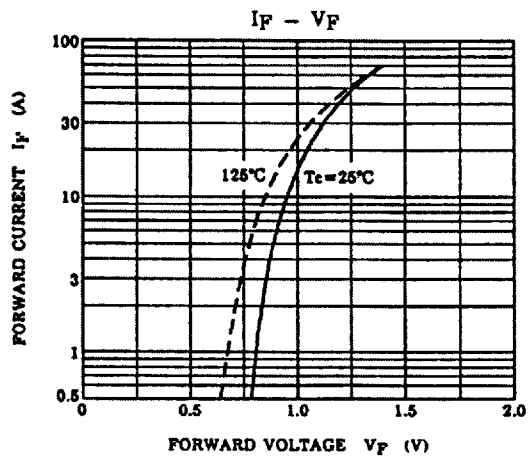

c. Brake Stage

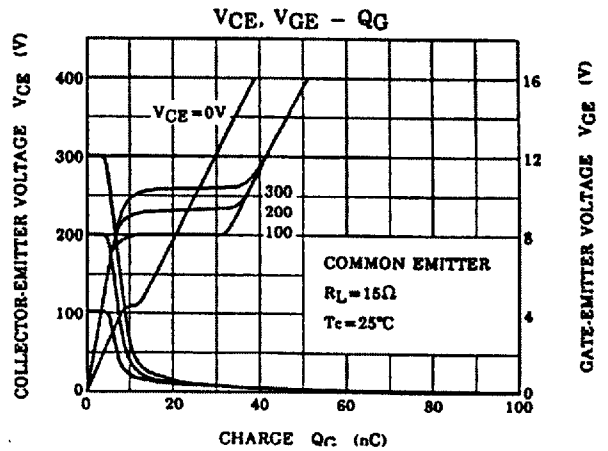
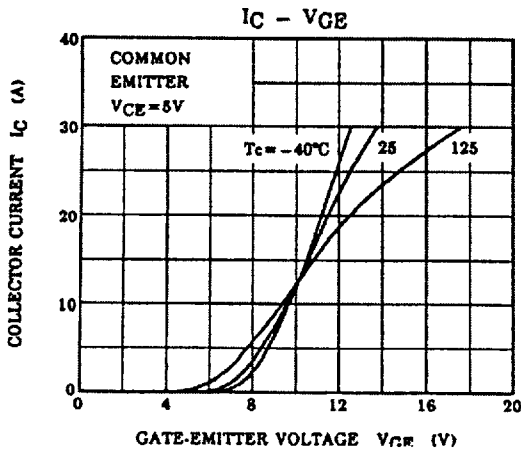
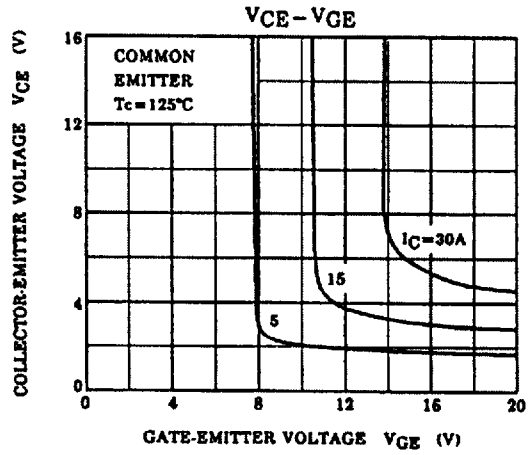
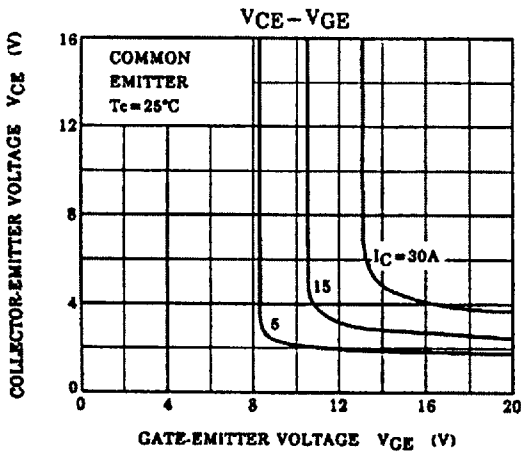
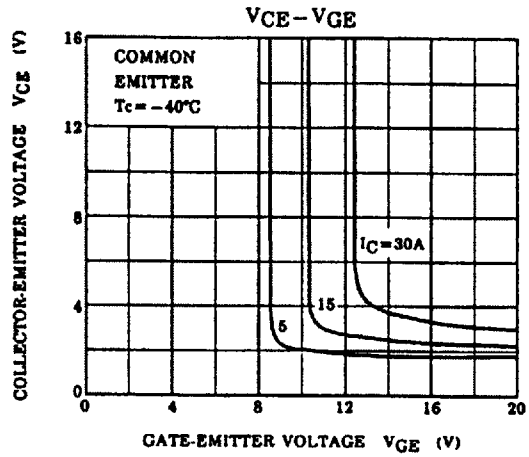
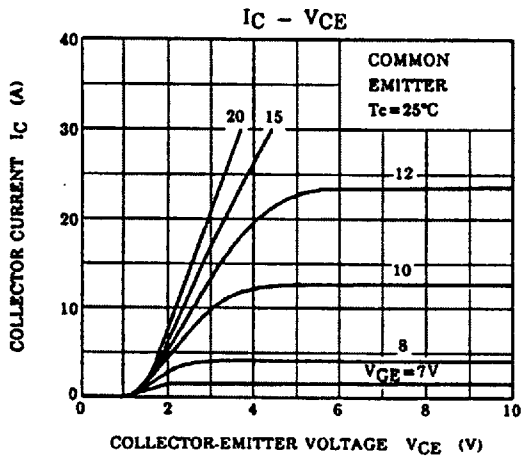

c. Brake Stage

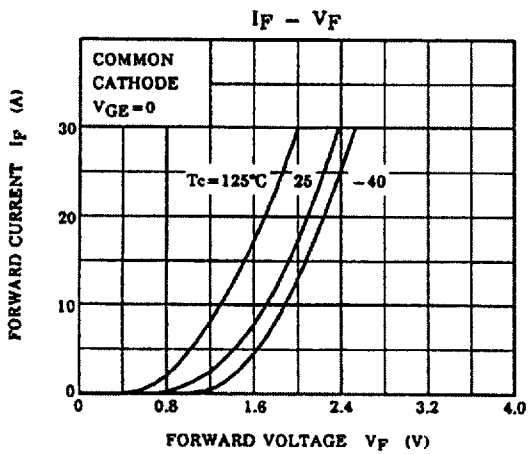
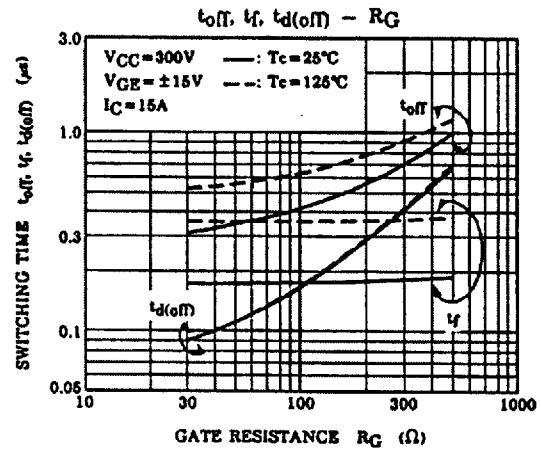
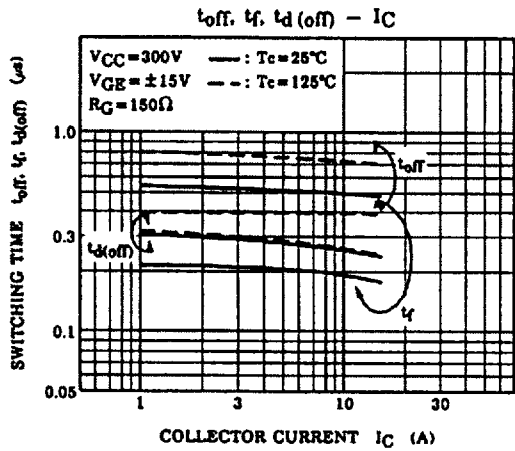
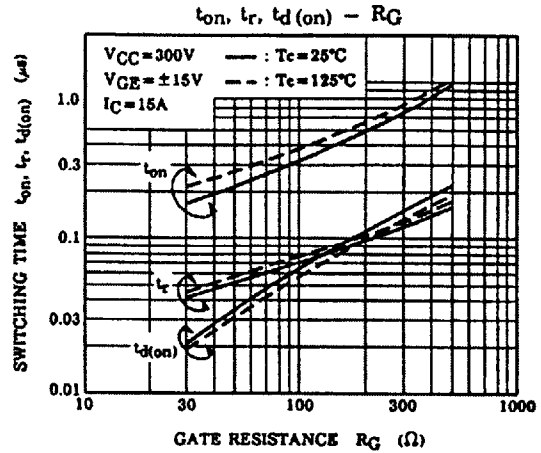
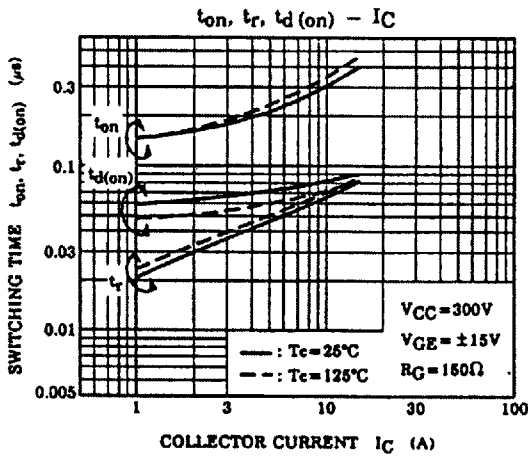

c. Brake Stage

