



**MIG50J901H**

**Maximum Ratings (Ta = 25°C)**

STAGE		CHARACTERISTIC		SYMBOL	RATINGS	UNIT	
Inverter	Collector-Emitter Voltage			$V_{CES}$	600	V	
	Gate-Emitter Voltage			$V_{GES}$	±20	V	
	Collector Current	DC		$I_C$	50	A	
		1ms		$I_{CP}$	100		
	Forward Current	DC		$I_F$	50	A	
		1ms		$I_{FM}$	100		
Collector Power Dissipation (tc = 25°C)			$P_C$	125	W		
Converter	Repetitive Peak Reverse Voltage			$V_{RRM}$	800	V	
	Average Output Rectified Current			$I_O$	30	A	
	Peak One Cycle Surge Forward Current (50Hz, Non-Repetitive)			$I_{FSM}$	400	A	
Brake	IGBT	Collector-Emitter Voltage			$V_{CES}$	600	V
		Gate-Emitter Voltage			$V_{GES}$	±20	V
		Collector Current	DC		$I_C$	25	A
			1ms		$I_{CP}$	50	
	Collector Power Dissipation (Tc = 25°C)			$P_C$	100	W	
	FRD	Repetitive Peak Reverse Voltage			$V_{RRM}$	600	V
		Forward Current	DC		$I_F$	15	A
			1ms		$I_{FM}$	30	
Junction Temperature			$T_j$	150	°C		
Storage Temperature Range			$T_{stg}$	-40 ~ 125	°C		
Isolation Voltage			$V_{isol}$	2500 (AC 1 minute)	V		
Screw Torque			—	3	N*m		

**Electrical Characteristics (Ta = 25°C)**

## a. Inverter Stage

CHARACTERISTIC		SYMBOL	TEST CONDITION	MIN.	TYP.	MX.	UNIT
Gate Leakage Current		$I_{GES}$	$V_{GE} = \pm 20V, V_{CE} = 0$	-	-	$\pm 20$	$\mu A$
Collector Cut-off Current		$I_{CES}$	$V_{CE} = 600V, V_{GE} = 0$	-	-	1.0	mA
Gate-Emitter Cut-off Voltage		$V_{GE (off)}$	$V_{CE} = 5V, I_C = 50mA$	3.0	-	6.0	V
Collector-Emitter Saturation Voltage		$V_{CE (sat)}$	$I_C = 50A, V_{GE} = 15V$	-	3.0	4.0	V
Input Capacitance		$C_{ies}$	$V_{CE} = 10V, V_{GE} = 0$ $f = 1MHz$	-	3100	-	pF
Switching Time	Turn-on Delay Time	$t_{d(on)}$	Inductive Load $V_{CC} = 300V$ $I_C = 50A$ $V_{GE} = \pm 15V$ $R_G = 51\Omega$ (Note 1)	-	0.08	0.16	$\mu s$
	Rise Time	$t_r$		-	0.12	0.24	
	Turn-on Time	$t_{on}$		-	0.40	0.80	
	Turn-off Delay Time	$t_{d(off)}$		-	0.30	0.60	
	Fall Time	$t_f$		-	0.15	0.30	
	Turn-off Time	$t_{off}$		-	0.60	1.00	
Forward Voltage		$V_F$	$I_F = 50A, V_{GE} = 0$	-	1.7	2.5	V
Reverse Recovery Time		$t_{rr}$	$I_F = 50A, V_{GE} = -10V$ $di/dt = 100A/\mu s$	-	0.08	0.15	$\mu s$
Thermal Resistance		$R_{th(j-c)}$	Transistor	-	-	1.0	$^{\circ}C/W$
			Diode	-	-	1.56	

## b. Converter Stage

CHARACTERISTIC	SYMBOL	TEST CONDITION	MIN.	TYP.	MX.	UNIT
Repetitive Peak Reverse Current	$I_{RRM}$	$V_{RRM} = 800V$	-	-	50	$\mu A$
Peak Forward Voltage	$V_{FM}$	$I_{FM} = 30A$	-	1.05	1.20	V
Peak One Cycle Surge Forward Current	$I_{FSM}$	50Hz Sine-half-wave	400	-	-	V
Thermal Resistance	$R_{th(j-c)}$		-	-	1.56	$^{\circ}C/W$

# MIG50J901H

## c. Brake Stage

CHARACTERISTIC		SYMBOL	TEST CONDITION	MIN.	TYP.	MX.	UNIT
Gate Leakage Current		$I_{GES}$	$V_{GE} = \pm 20V, V_{CE} = 0$	-	-	$\pm 500$	nA
Collector Cut-off Current		$I_{CES}$	$V_{CE} = 600V, V_{GE} = 0$	-	-	1.0	mA
Repetitive Peak Reverse Current		$I_{RRM}$	$V_{RRM} = 600V$	-	-	1.0	mA
Gate-Emitter Cut-off Voltage		$V_{GE(off)}$	$V_{CE} = 5V, I_C = 25mA$	3.0	-	6.0	V
Collector-Emitter Saturation Voltage		$V_{CE(sat)}$	$I_C = 25A, V_{GE} = 15V$	-	3.0	4.0	V
Input Capacitance		$C_{ies}$	$V_{CE} = 10V, V_{GE} = 0, f = 1MHz$	-	2000	-	pF
Switching Time	Turn-on Delay Time	$t_d(on)$	Inductive Load $V_{CC} = 300V$ $I_C = 25A$ $V_{GE} = \pm 15V$ $R_G = 100\Omega$ (Note 1)	-	0.08	0.16	$\mu s$
	Rise Time	$t_r$		-	0.12	0.24	
	Turn-on Time	$t_{on}$		-	0.40	0.80	
	Turn-off Delay Time	$t_d(off)$		-	0.30	0.60	
	Fall Time	$t_f$		-	0.30	0.55	
	Turn-off Time	$t_{off}$		-	0.65	1.00	
Forward Voltage		$V_F$	$I_F = 15A, V_{GE} = 0$	-	1.7	2.5	V
Thermal Resistance		$R_{th(j-c)}$	Transistor	-	-	1.25	$^{\circ}C/W$
			Diode	-	-	2.80	

Note. 1 Switching Time Test Circuit & Timing Chart

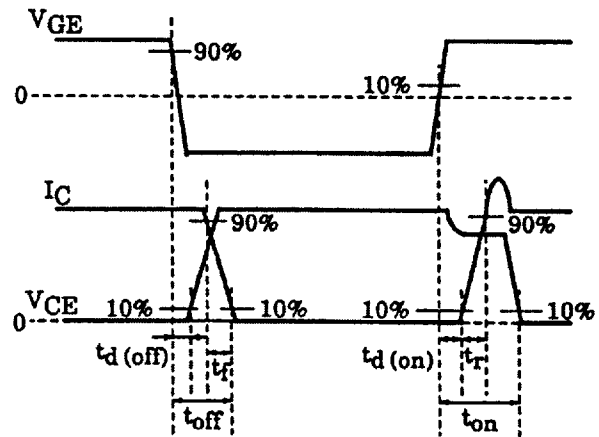
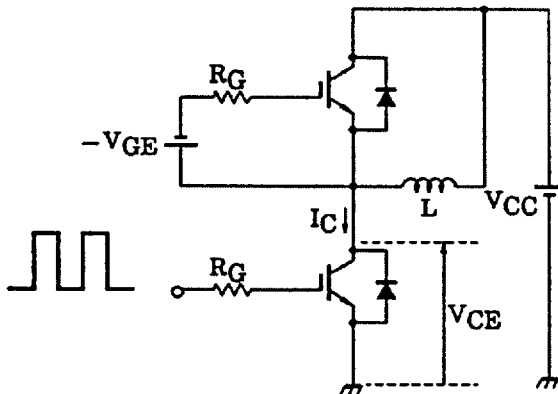

a. Inverter Stage

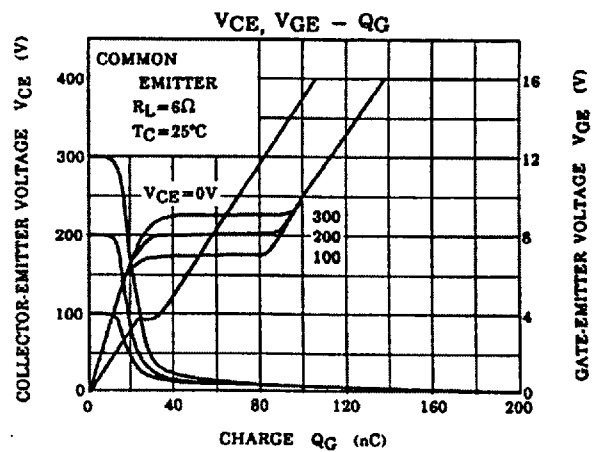
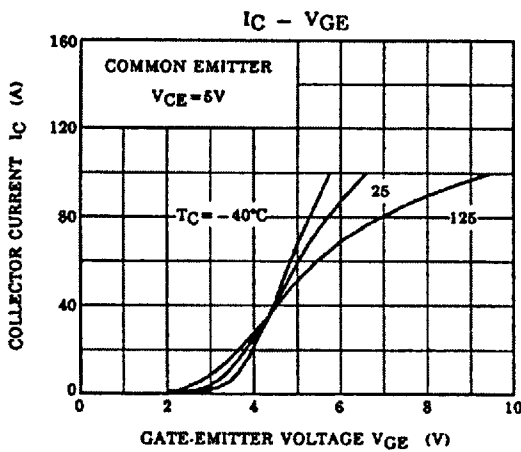
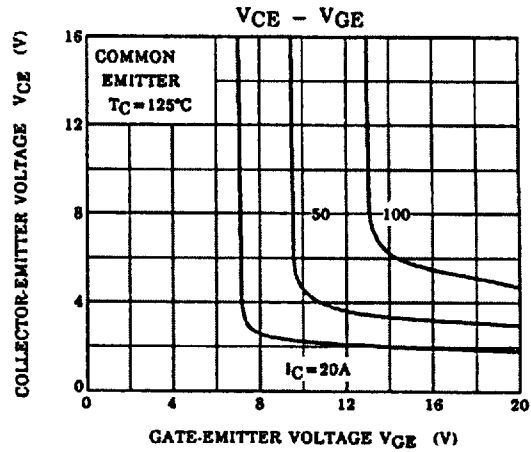
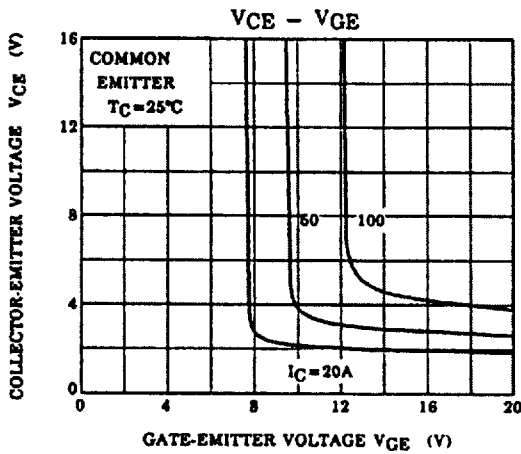
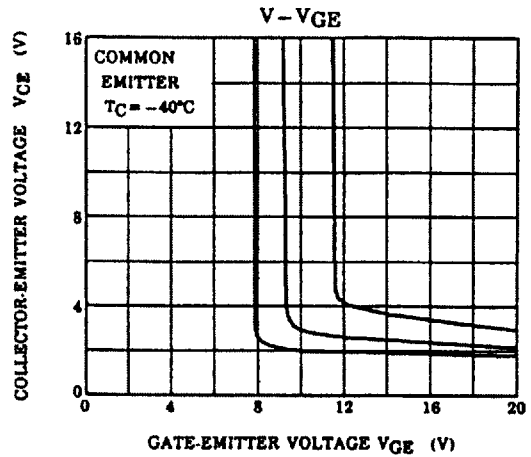
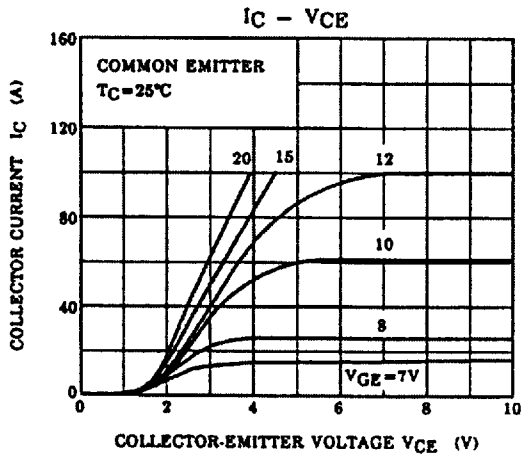

MIG50J901H

a. Inverter Stage

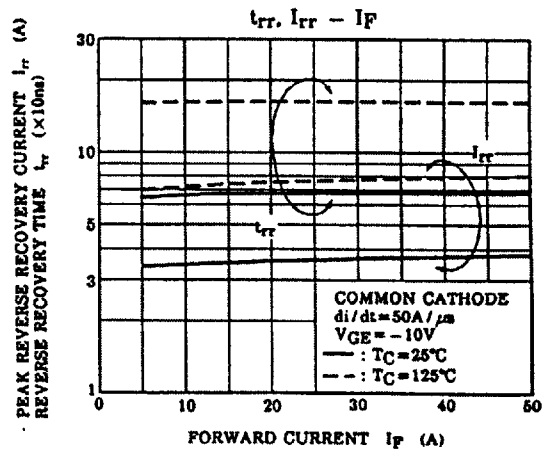
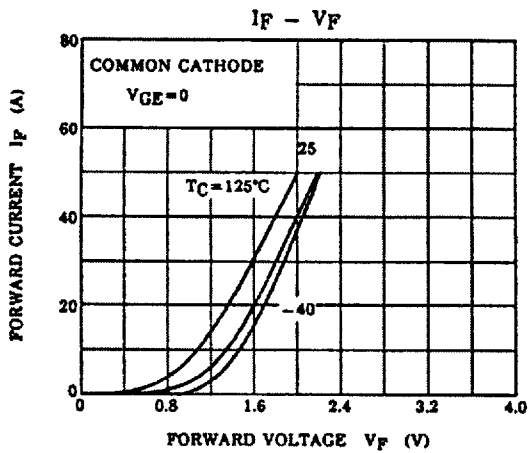
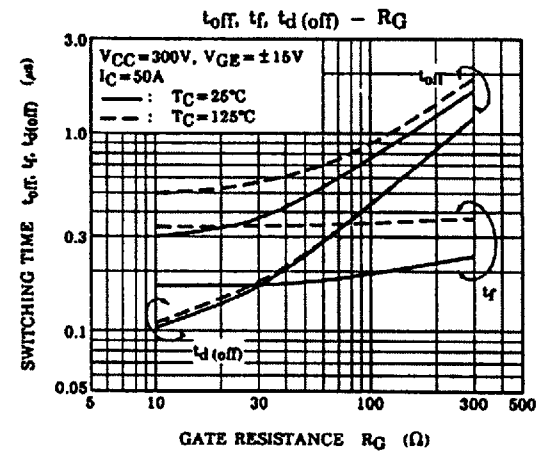
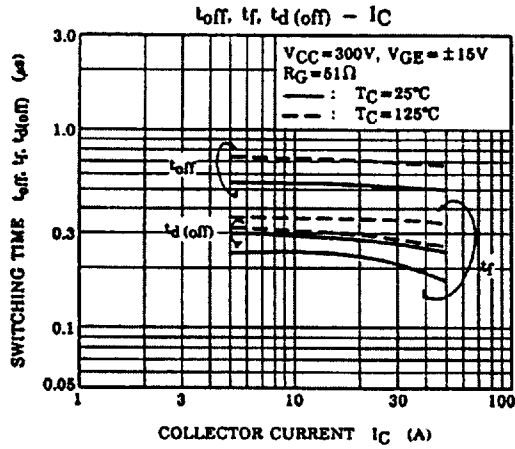
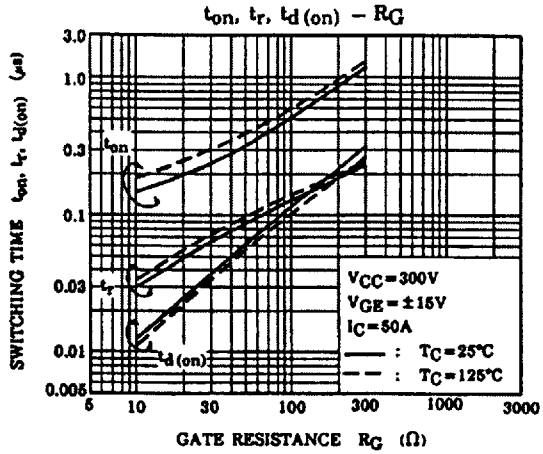
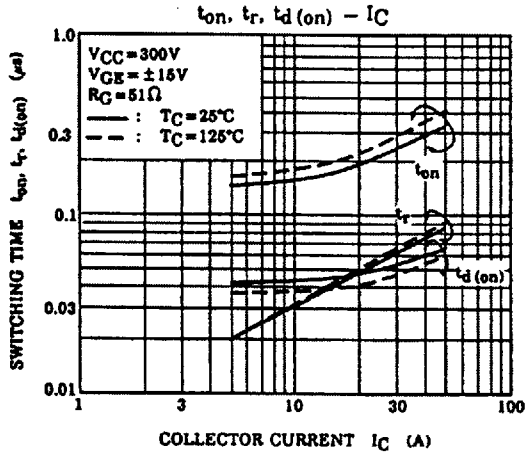

a. Inverter Stage

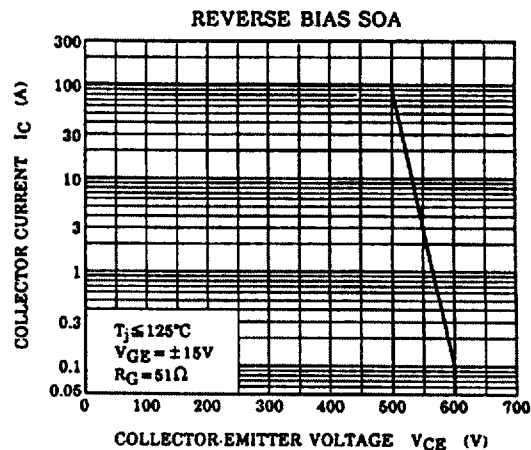
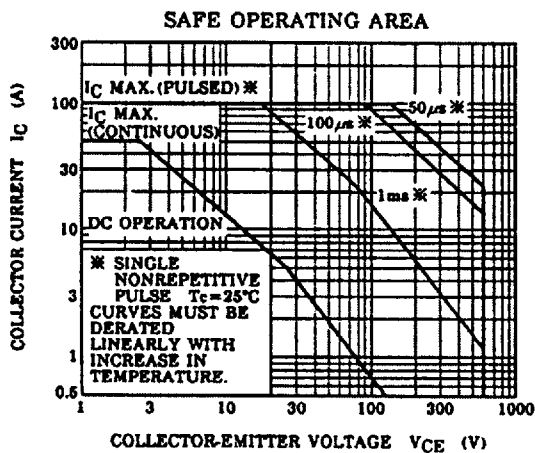
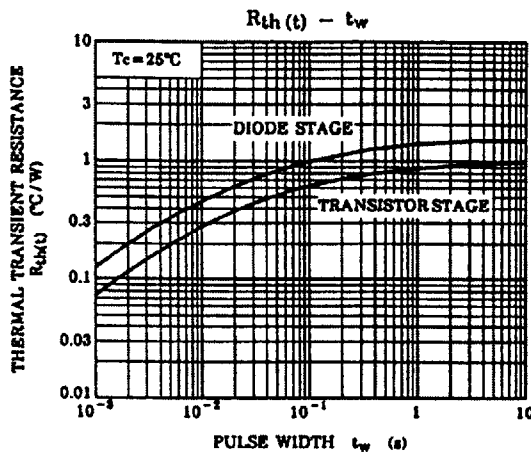
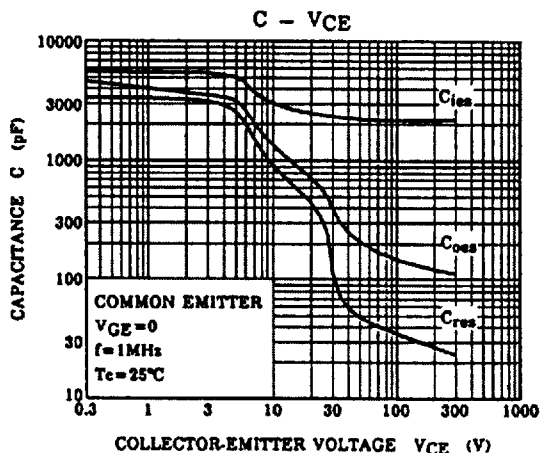

b. Converter Stage

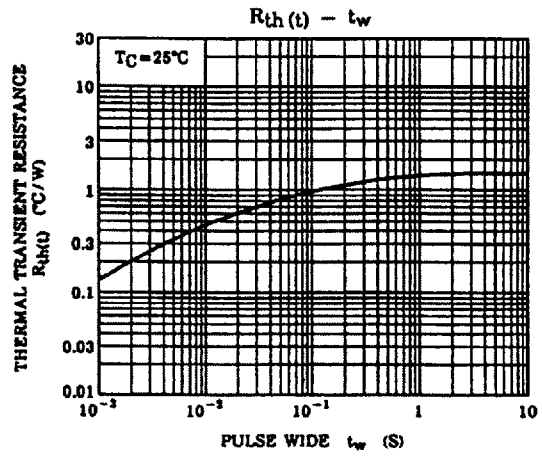
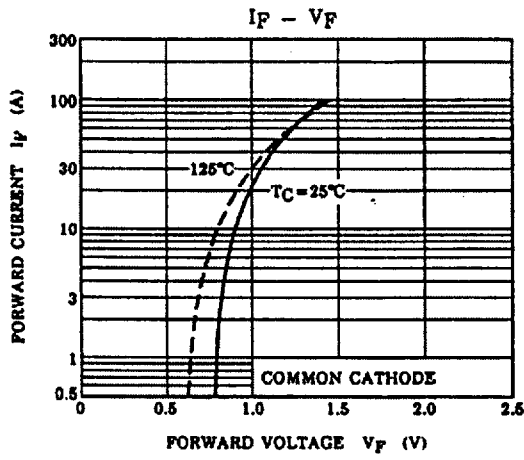



c. Brake Stage

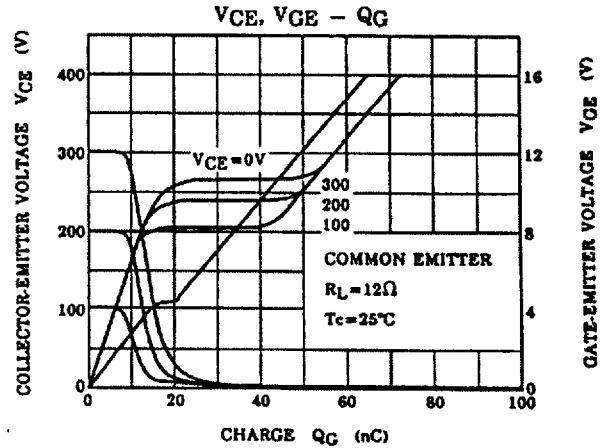
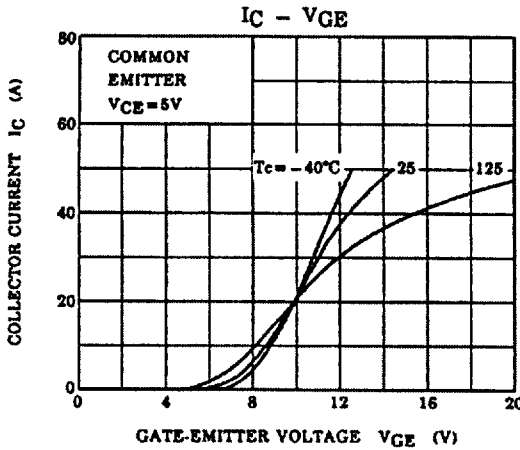
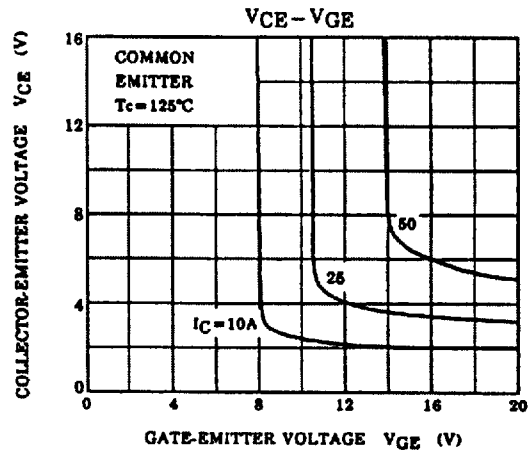
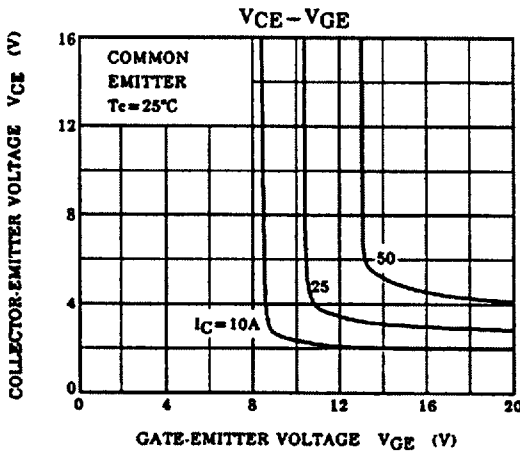
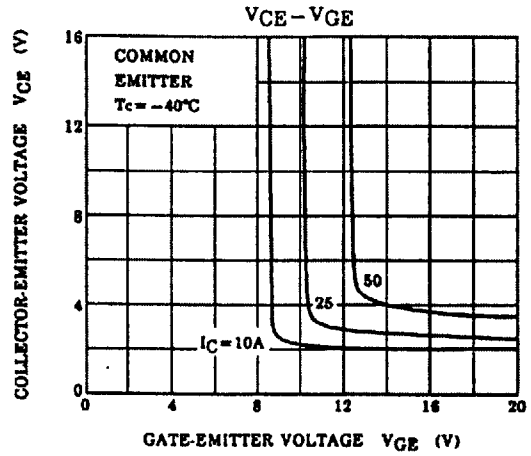
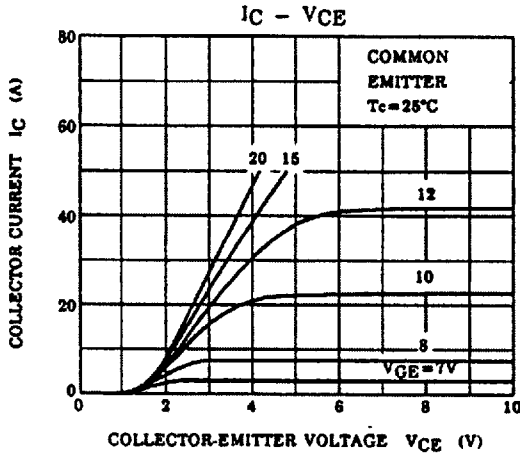

MIG50J901H

c. Brake Stage

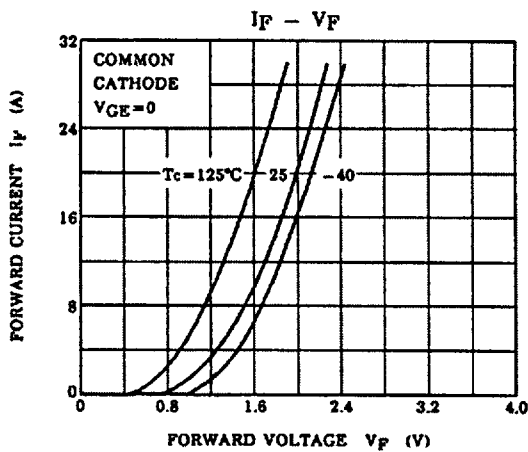
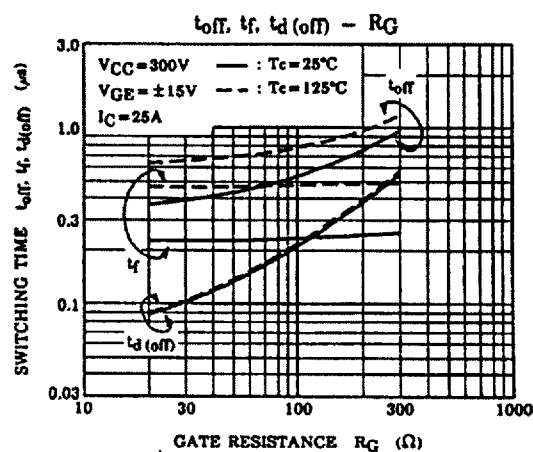
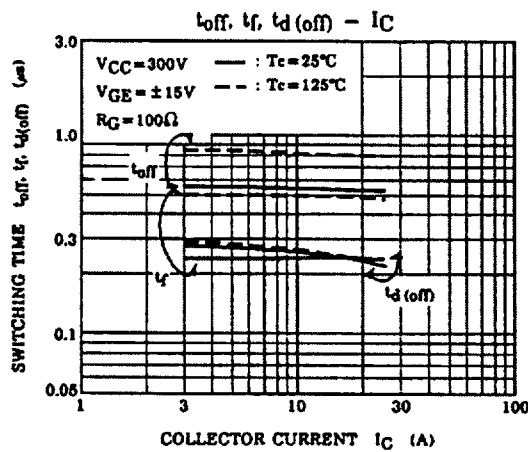
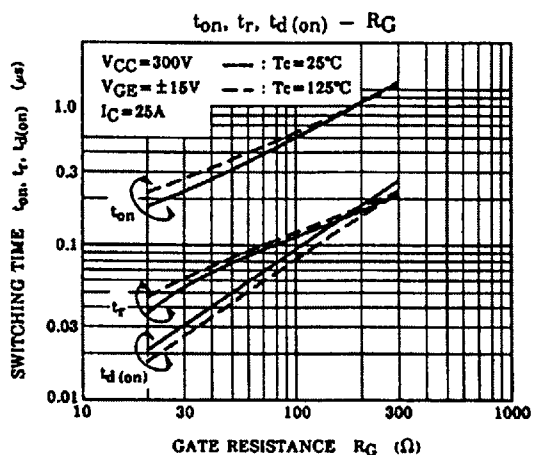
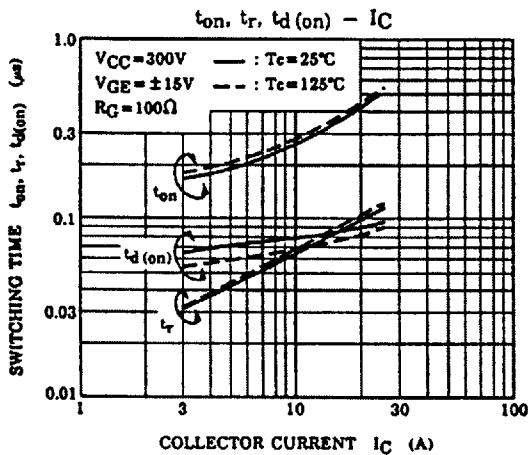

c. Brake Stage

