

**Dual Buck chopper
MOSFET Power Module**

**$V_{DSS} = 500V$
 $R_{DSon} = 100m\Omega \text{ max @ } T_j = 25^\circ C$
 $I_D = 37A \text{ @ } T_c = 25^\circ C$**

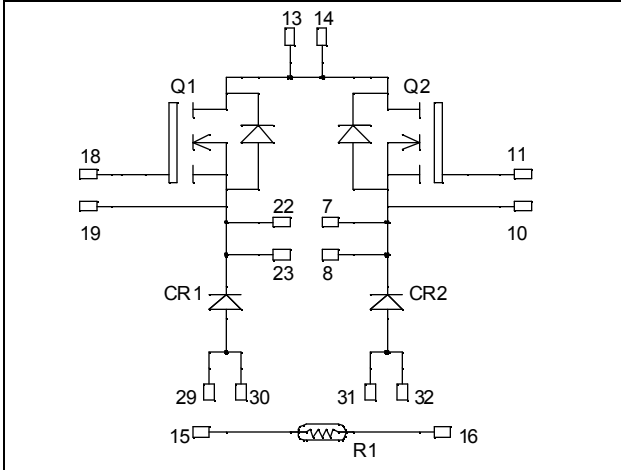

Application

- AC and DC motor control
- Switched Mode Power Supplies

Features

- Power MOS 7[®] MOSFETs
 - Low R_{DSon}
 - Low input and Miller capacitance
 - Low gate charge
 - Avalanche energy rated
 - Very rugged
- Kelvin source for easy drive
- Very low stray inductance
 - Symmetrical design
- Internal thermistor for temperature monitoring
- High level of integration

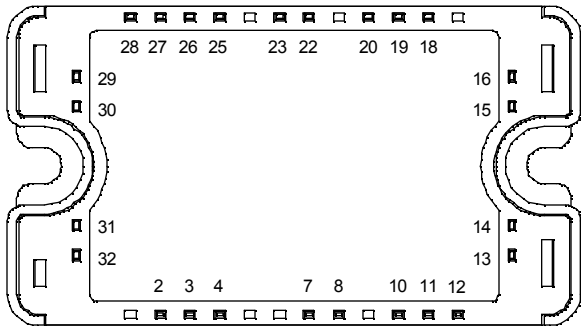

Benefits

- Outstanding performance at high frequency operation
- Direct mounting to heatsink (isolated package)
- Low junction to case thermal resistance
- Solderable terminals both for power and signal for easy PCB mounting
- Low profile
- Each leg can be easily paralleled to achieve a single buck of twice the current capability

All multiple inputs and outputs must be shorted together
Example: 13/14 ; 29/30 ; 22/23 ...

Absolute maximum ratings

Symbol	Parameter	Max ratings	Unit
V_{DSS}	Drain - Source Breakdown Voltage	500	V
I_D	Continuous Drain Current	$T_c = 25^\circ C$	37
		$T_c = 80^\circ C$	28
I_{DM}	Pulsed Drain current	140	A
V_{GS}	Gate - Source Voltage	± 30	V
R_{DSon}	Drain - Source ON Resistance	100	$m\Omega$
P_D	Maximum Power Dissipation	$T_c = 25^\circ C$	312
I_{AR}	Avalanche current (repetitive and non repetitive)	41	A
E_{AR}	Repetitive Avalanche Energy	50	mJ
E_{AS}	Single Pulse Avalanche Energy	1600	

CAUTION: These Devices are sensitive to Electrostatic Discharge. Proper Handling Procedures Should Be Followed.

All ratings @ $T_j = 25^\circ\text{C}$ unless otherwise specified

Electrical Characteristics

Symbol	Characteristic	Test Conditions	Min	Typ	Max	Unit	
I_{DSS}	Zero Gate Voltage Drain Current	$V_{GS} = 0\text{V}$ $V_{DS} = 500\text{V}$	$T_j = 25^\circ\text{C}$			100	μA
			$T_j = 125^\circ\text{C}$			500	
$R_{DS(on)}$	Drain – Source on Resistance	$V_{GS} = 10\text{V}, I_D = 18.5\text{A}$			100	$\text{m}\Omega$	
$V_{GS(th)}$	Gate Threshold Voltage	$V_{GS} = V_{DS}, I_D = 1\text{mA}$	3		5	V	
I_{GSS}	Gate – Source Leakage Current	$V_{GS} = \pm 30\text{V}, V_{DS} = 0\text{V}$			± 100	nA	

Dynamic Characteristics

Symbol	Characteristic	Test Conditions	Min	Typ	Max	Unit
C_{iss}	Input Capacitance	$V_{GS} = 0\text{V}$ $V_{DS} = 25\text{V}$ $f = 1\text{MHz}$		4367		pF
C_{oss}	Output Capacitance			894		
C_{rss}	Reverse Transfer Capacitance			61		
Q_g	Total gate Charge	$V_{GS} = 10\text{V}$ $V_{Bus} = 250\text{V}$ $I_D = 37\text{A}$		96		nC
Q_{gs}	Gate – Source Charge			24		
Q_{gd}	Gate – Drain Charge			49		
$T_{d(on)}$	Turn-on Delay Time	Inductive switching @ 125°C $V_{GS} = 15\text{V}$ $V_{Bus} = 333\text{V}$ $I_D = 37\text{A}$ $R_G = 5\Omega$		15		ns
T_r	Rise Time			21		
$T_{d(off)}$	Turn-off Delay Time			73		
T_f	Fall Time			52		
E_{on}	Turn-on Switching Energy ❶	Inductive switching @ 25°C $V_{GS} = 15\text{V}, V_{Bus} = 333\text{V}$ $I_D = 37\text{A}, R_G = 5\Omega$		566		μJ
E_{off}	Turn-off Switching Energy ❷			545		
E_{on}	Turn-on Switching Energy ❶	Inductive switching @ 125°C $V_{GS} = 15\text{V}, V_{Bus} = 333\text{V}$ $I_D = 37\text{A}, R_G = 5\Omega$		931		μJ
E_{off}	Turn-off Switching Energy ❷			635		

Diode ratings and characteristics

Symbol	Characteristic	Test Conditions	Min	Typ	Max	Unit
V_{RRM}	Maximum Peak Repetitive Reverse Voltage		600			V
I_{RM}	Maximum Reverse Leakage Current	$V_R = 600\text{V}$	$T_j = 25^\circ\text{C}$		250	μA
			$T_j = 125^\circ\text{C}$		750	
$I_{F(AV)}$	Maximum Average Forward Current	50% duty cycle $T_c = 70^\circ\text{C}$		30		A
V_F	Diode Forward Voltage	$I_F = 30\text{A}$		2.2	2.7	V
		$I_F = 60\text{A}$		2.7		
		$I_F = 30\text{A}$	$T_j = 150^\circ\text{C}$	1.5		
t_{rr}	Reverse Recovery Time	$I_F = 30\text{A}$ $V_R = 400\text{V}$ $di/dt = 200\text{A}/\mu\text{s}$	$T_j = 25^\circ\text{C}$		74	ns
			$T_j = 100^\circ\text{C}$		74	
Q_{rr}	Reverse Recovery Charge	$I_F = 30\text{A}$ $V_R = 400\text{V}$ $di/dt = 200\text{A}/\mu\text{s}$	$T_j = 25^\circ\text{C}$		123	nC
			$T_j = 100^\circ\text{C}$		288	

❶ E_{on} includes diode reverse recovery.

❷ In accordance with JEDEC standard JESD24-1.

Thermal and package characteristics

Symbol	Characteristic	Min	Typ	Max	Unit	
R _{thJC}	Junction to Case	IGBT		0.4	°C/W	
		Diode		1.2		
V _{ISOL}	RMS Isolation Voltage, any terminal to case t=1 min, I _{isol} <1mA, 50/60Hz	2500			V	
T _J	Operating junction temperature range	-40		150	°C	
T _{STG}	Storage Temperature Range	-40		125		
T _C	Operating Case Temperature	-40		100		
Torque	Mounting torque		To heatsink	M4	4.7	N.m
Wt	Package Weight				110	g

Temperature sensor NTC

Symbol	Characteristic	Min	Typ	Max	Unit
R ₂₅	Resistance @ 25°C		68		kΩ
B _{25/85}	T ₂₅ = 298.16 K		4080		K

$$R_T = \frac{R_{25}}{\exp\left[B_{25/85}\left(\frac{1}{T_{25}} - \frac{1}{T}\right)\right]}$$

T: Thermistor temperature
R_T: Thermistor value at T

Package outline

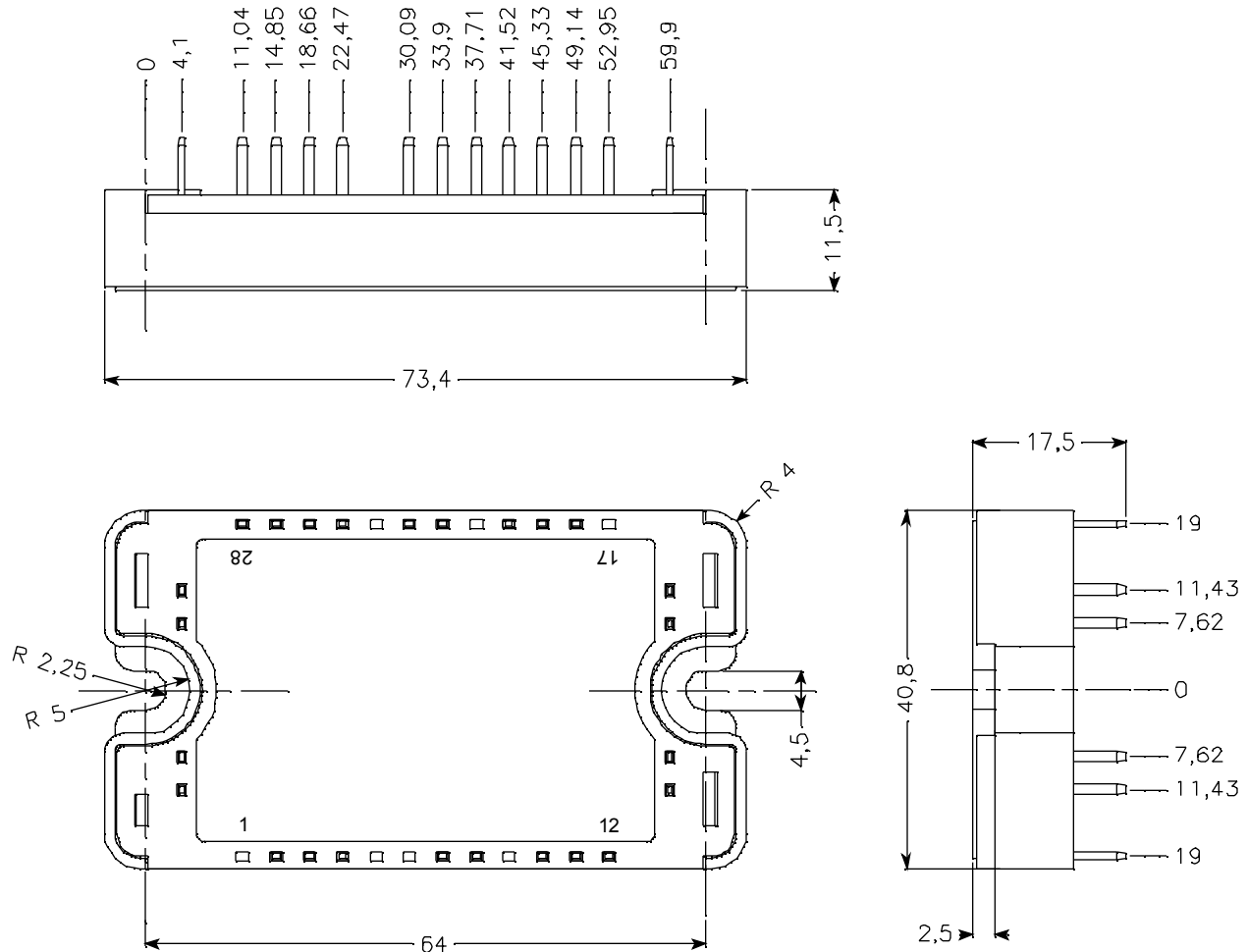

Typical Performance Curve

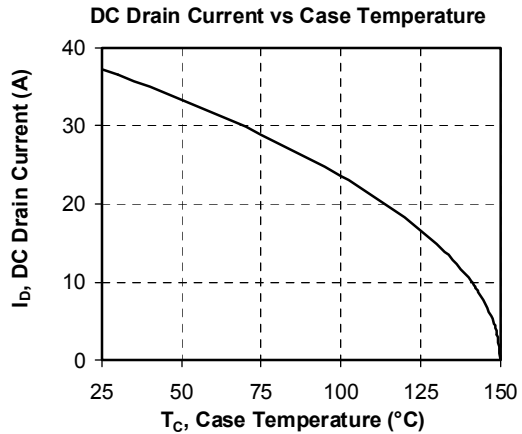
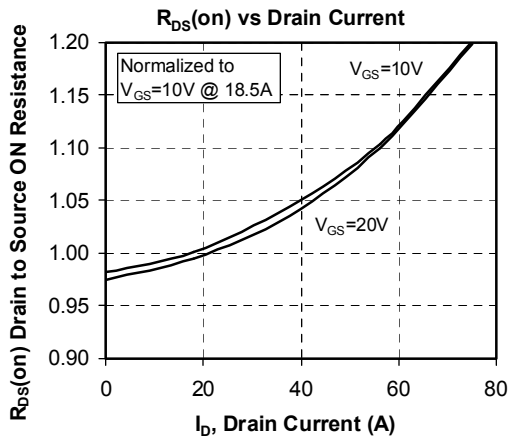
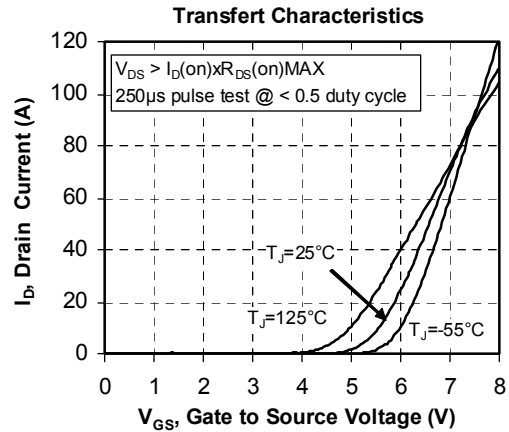
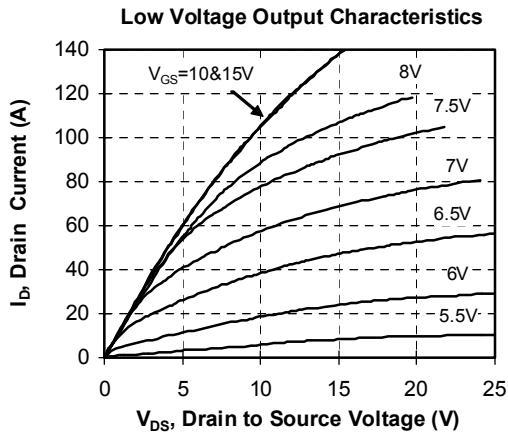
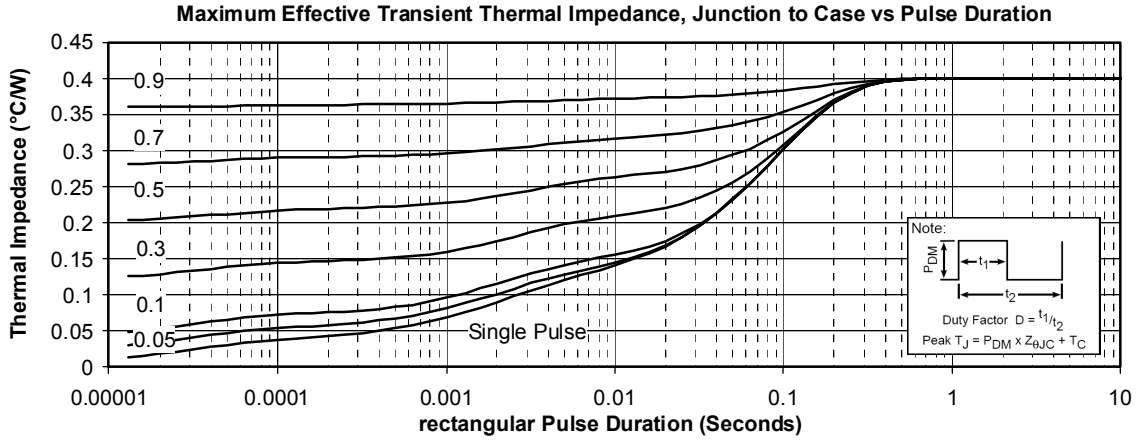

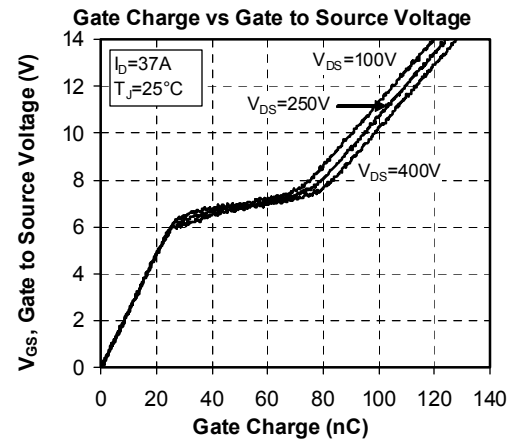
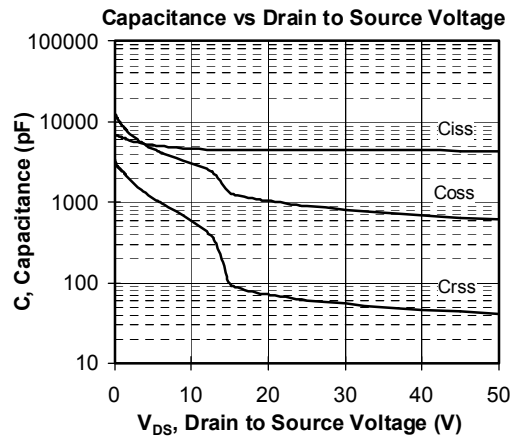
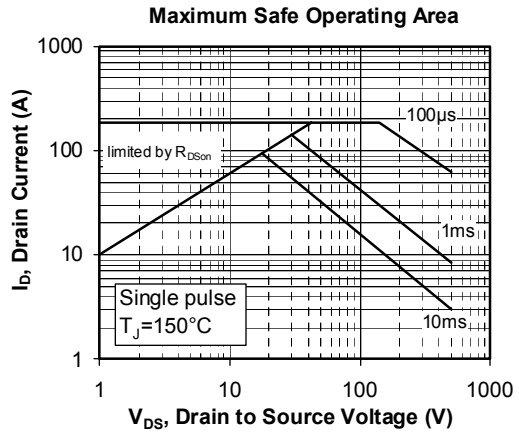
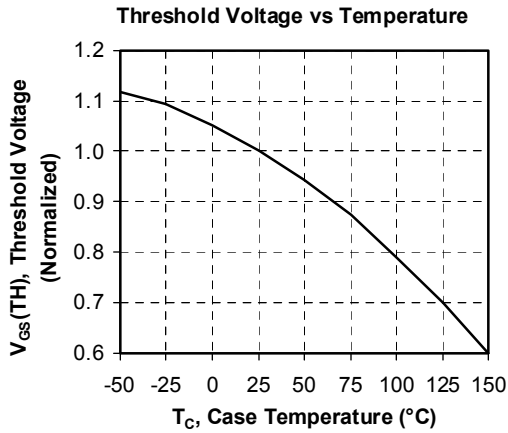
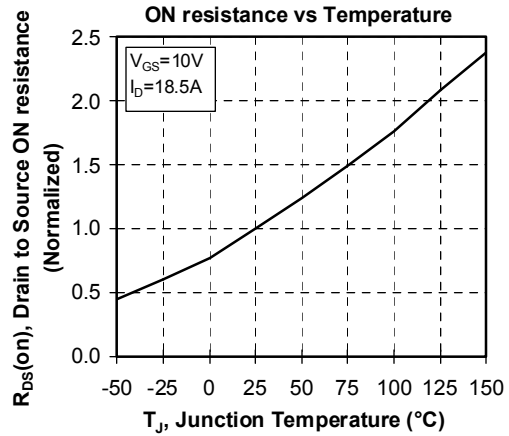
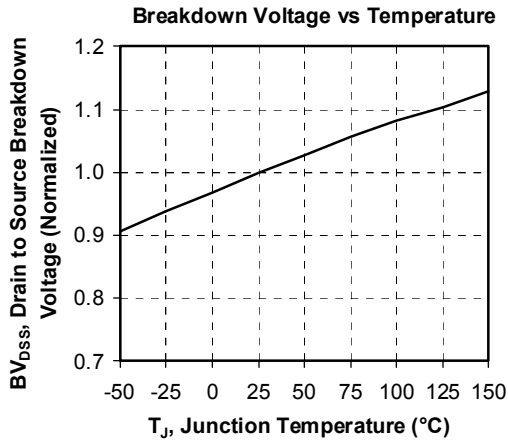

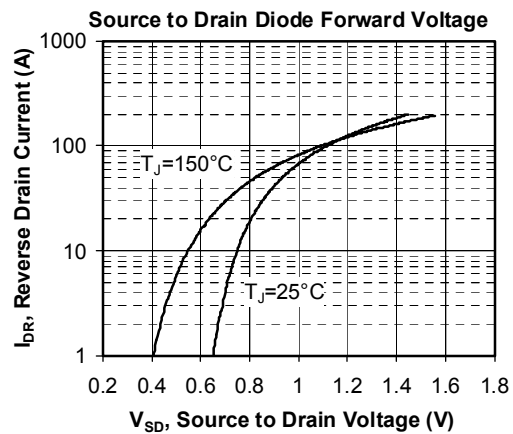
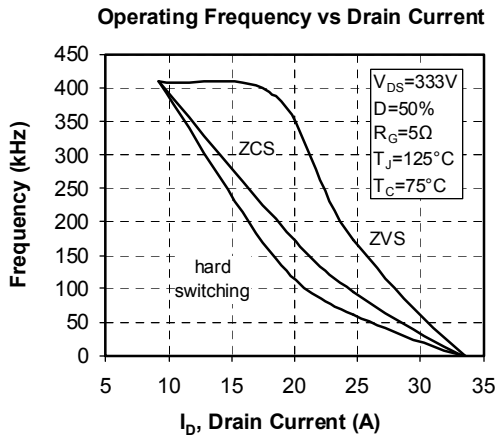
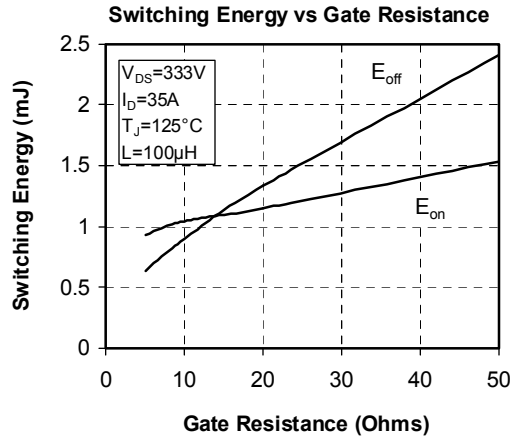
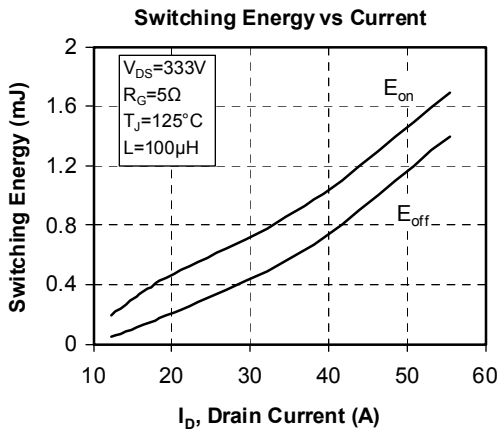
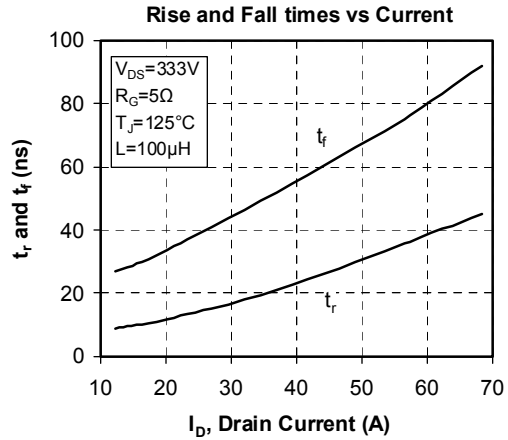
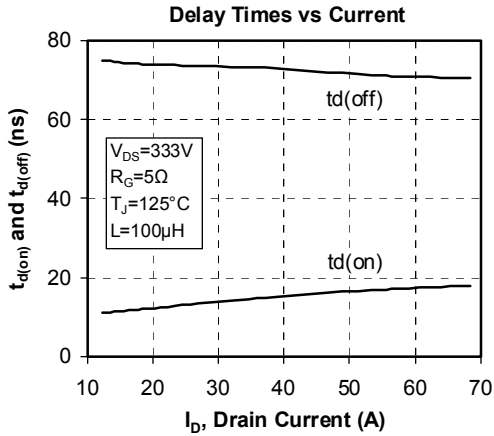

APT reserves the right to change, without notice, the specifications and information contained herein

APT's products are covered by one or more of U.S. patents 4,895,810 5,045,903 5,089,434 5,182,234 5,019,522 5,262,336 6,503,786 5,256,583 4,748,103 5,283,202 5,231,474 5,434,095 5,528,058 and foreign patents. U.S. and Foreign patents pending. All Rights Reserved.