

The MRFIC Line 2.4 GHz GaAs Downconverter

The MRFIC2401 is a GaAs low-noise amplifier and downmixer in a low-cost 16 lead plastic package designed for use in the 2.4 to 2.5 GHz Industrial-Scientific-Medical (ISM) band. The design is optimized for efficiency at 5.0 Volt operation at 2.45 GHz but is usable from 2.0 to 3.0 GHz in applications such as telemetry and Multichannel Multipoint Distribution System (MMDS) wireless cable TV systems. Performance is suitable for frequency hopping or direct sequence spread spectrum as well as single-frequency applications. LNA output and mixer input are available to allow image filtering.

- Single Supply Voltage = 5.0 Volts
- High Conversion Gain = 21 dB Typical Less Image Filter
- Low Supply Current = 9.5 mA Typical
- Low-Cost, Low Profile Plastic SOIC Package
- Available in Tape and Reel by Adding R2 Suffix to Part Number.
R2 Suffix = 2,500 Units per 16 mm, 13 inch Reel.
- Device Marking = M2401

MRFIC2401

**2.4 GHz
DOWNCONVERTER
GaAs MONOLITHIC
INTEGRATED CIRCUIT**

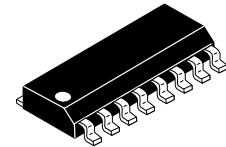

**CASE 751B-05
(SO-16)**

ABSOLUTE MAXIMUM RATINGS (T_A = 25°C unless otherwise noted)

Parameter	Symbol	Value	Unit
Supply Voltage	V _{DD}	6.0	Vdc
Input Power, RF IN Ports	P _{RF}	+5.0	dBm
Input Power, LO IN Port	P _{LO}	+5.0	dBm
Ambient Operating Temperature	T _A	-30 to +85	°C
Storage Temperature	T _{stg}	-65 to +125	°C
Bias Control Voltage	STANDBY	6.0	Vdc

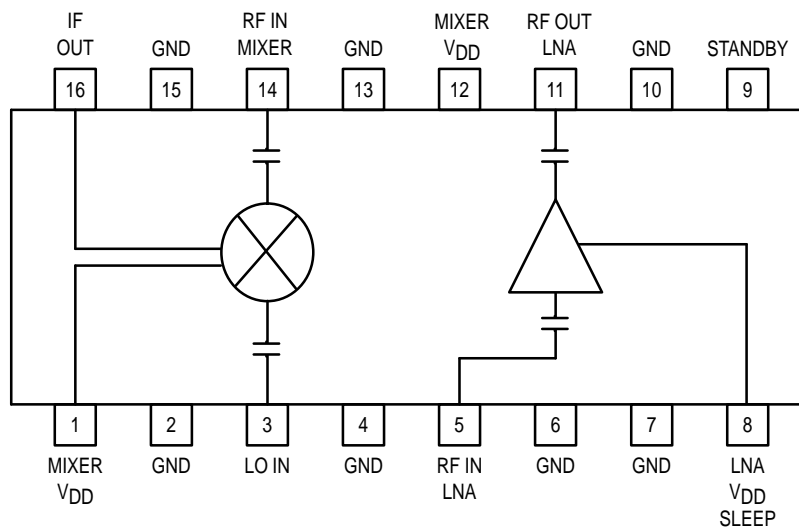

Pin Connections and Functional Block Diagram

RECOMMENDED OPERATING CONDITIONS

Parameter	Symbol	Value	Unit
Supply Voltage	V_{DD}	4.75 to 5.25	Vdc
IF Frequency Range	f_{IF}	100 to 350	MHz
LO Drive Power Level	P_{LO}	-10 to 0	dBm
LO Frequency Range	f_{LO}	2050 to 2400	MHz
RF Frequency Range	f_{RF}	2400 to 2500	MHz
STANDBY Mode ON	STANDBY	V_{DD}	Vdc
STANDBY Mode OFF	STANDBY	0	Vdc
SLEEP Mode OFF	SLEEP	V_{DD}	Vdc
SLEEP Mode ON	SLEEP	0	Vdc

ELECTRICAL CHARACTERISTICS ($V_{DD} = 5.0$ Vdc, $T_A = 25^\circ\text{C}$, RF = 2.45 GHz, LO = 2.125 GHz @ -5.0 dBm, STANDBY = 0 Vdc)

Characteristic	Min	Typ	Max	Unit
Conversion Gain – Downconverter (Less Image Filter Loss)	19	21	–	dB
Gain – LNA	–	17	–	dB
Conversion Gain – Mixer	–	4.0	–	dB
Noise Figure – LNA	–	1.9	–	dB
Noise Figure – Mixer	–	11	–	dB
Return Loss – Mixer Input, LO Input, LNA Output	–	10	–	dB
Input Third Order Intercept – Downconverter (Less Image Filter Loss)	–	-18	–	dBm
Input Third Order Intercept – LNA	–	-13	–	dBm
Input Third Order Intercept – Mixer	–	0	–	dBm
Reverse Isolation – Downconverter (Less Image Filter Loss)	–	30	–	dB
Isolation – LO to RF, LO to IF	–	20	–	dB
Supply Current – Downconverter	–	9.5	11	mA
SLEEP Mode Supply Current – Downconverter (No LO, STANDBY = 5 Vdc, $V_{DD}/SLEEP = 5$ Vdc)	–	600	–	μA
Turn On, Turn Off Time – LNA	–	1.0	–	μs

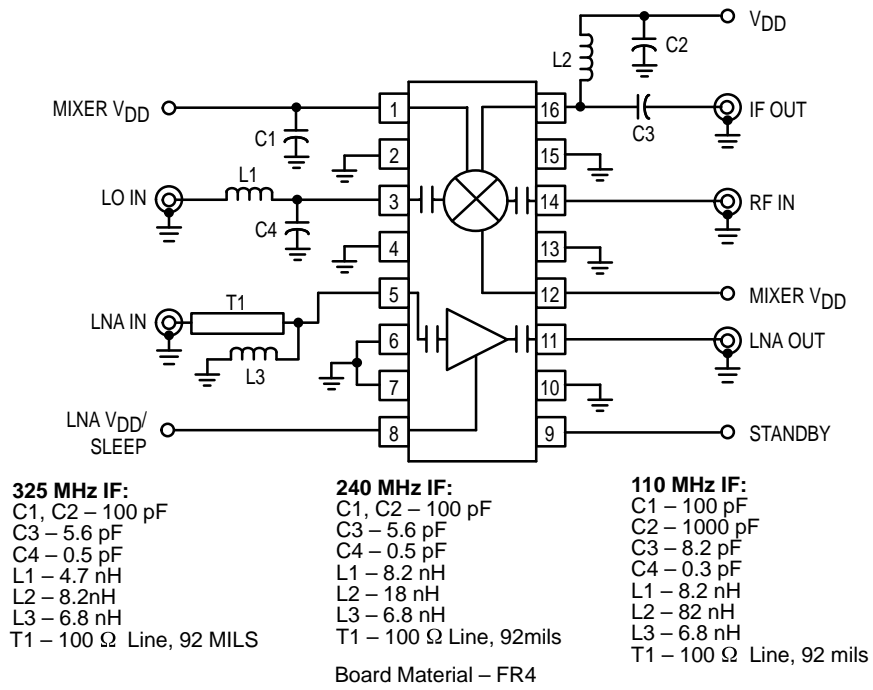

Figure 1. Applications Circuit Configuration

f Frequency (GHz)	LO Z_{in}	
	R	jX
2.0	39.7	23.9
2.1	35.7	22.1
2.2	32.1	19.8
2.3	29.1	17.1
2.4	26.5	14.0
2.5	24.4	10.7

Table 1. Selected Port Impedances
(from Conjugate Match)

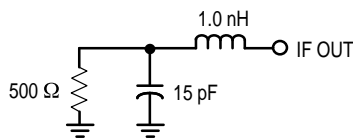

Figure 2. Equivalent IF Output Circuit

Table 2. LNA Scattering Parameters(VDD = 5 V, T_A = 25°C, 50 Ω System)

f (MHz)	S ₁₁		S ₂₁		S ₁₂		S ₂₂	
	S ₁₁	∠ φ	S ₂₁	∠ φ	S ₁₂	∠ φ	S ₂₂	∠ φ
2000	0.823	-50.8	5.35	14.3	0.0373	164.2	0.609	-64.1
2050	0.783	-62.9	6.13	-0.3	0.0425	154.3	0.558	-78.7
2100	0.752	-76.8	6.56	-18.3	0.0477	138	0.497	-94.3
2150	0.713	-89.8	6.8	-34	0.05	121	0.425	-110.7
2200	0.656	-104.2	7.14	-50.2	0.0511	106.4	0.343	-129.6
2250	0.583	-119	7.44	-66.4	0.0527	91.8	0.25	-152.3
2300	0.509	-134.1	7.8	-84.2	0.0554	78.1	0.155	176.2
2350	0.425	-148.2	7.86	-102.6	0.0579	59.89	0.088	120.7
2400	0.34	-163.6	7.84	-119.4	0.0552	42.31	0.111	43.8
2450	0.261	-177.8	7.78	-138.1	0.0528	28.27	0.191	2.2
2500	0.175	173.4	7.43	-154.6	0.0514	13.37	0.269	-21.9
2550	0.103	170.4	7.15	-170.6	0.0484	-0.842	0.338	-41.8
2600	0.056	-160.5	6.72	173	0.0455	-15.4	0.393	-59.4
2650	0.067	-130.7	6.47	159.1	0.0422	-28.11	0.436	-76.2
2700	0.102	-117.8	6.25	142.3	0.039	-41.5	0.472	-92.2
2750	0.132	-119.5	5.53	127.1	0.0353	-53.47	0.496	-107.5
2800	0.166	-125.2	5.26	117.5	0.0329	-63.28	0.513	-121.3
2850	0.19	-134.8	5.15	102.4	0.0309	-75.04	0.533	-135
2900	0.219	-144.8	4.71	87.6	0.0283	-87.86	0.547	-148.8
2950	0.235	-155.9	4.43	76.1	0.025	-95.83	0.559	-162.4
3000	0.262	-165.9	4.08	62.3	0.0235	-108.4	0.57	-175.7

TYPICAL CHARACTERISTICS

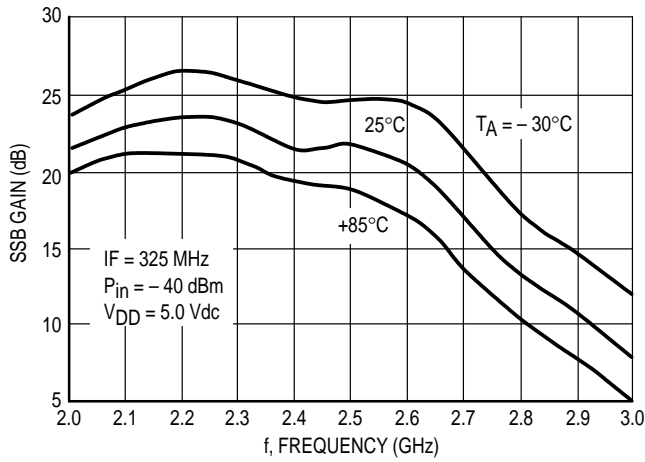

Figure 3. Downconverter Gain versus Frequency

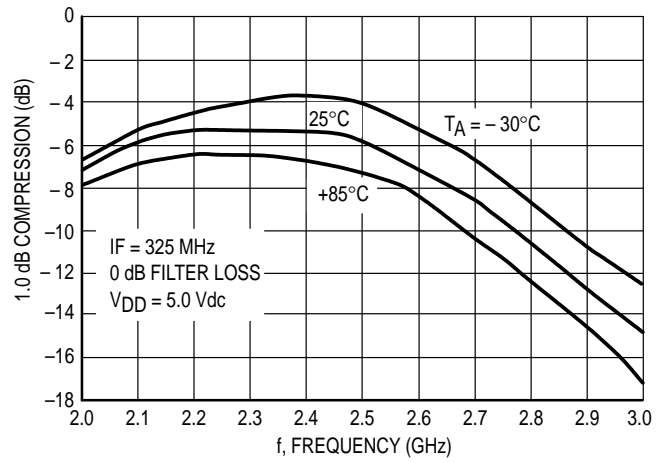

Figure 4. Downconverter 1.0 dB Compression versus Frequency

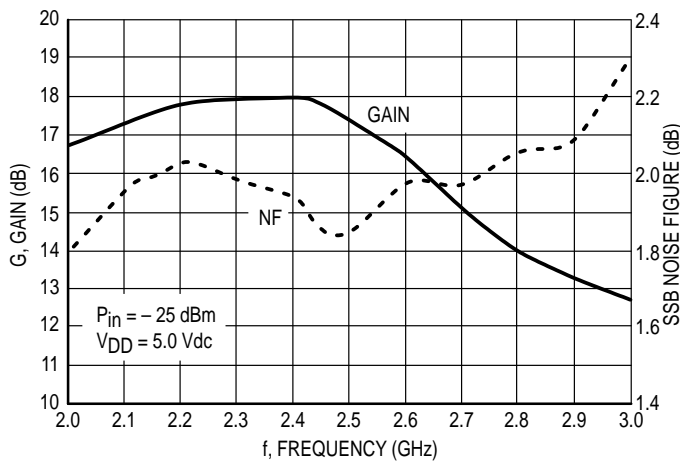

Figure 5. LNA Gain and Noise Figure versus Frequency

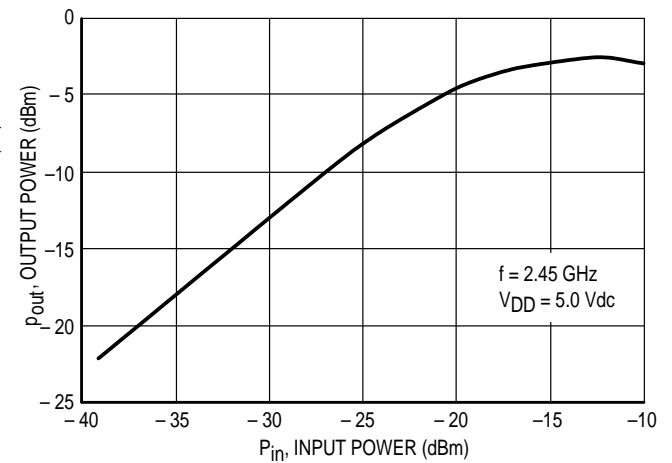

Figure 6. LNA Output Power versus Input Power

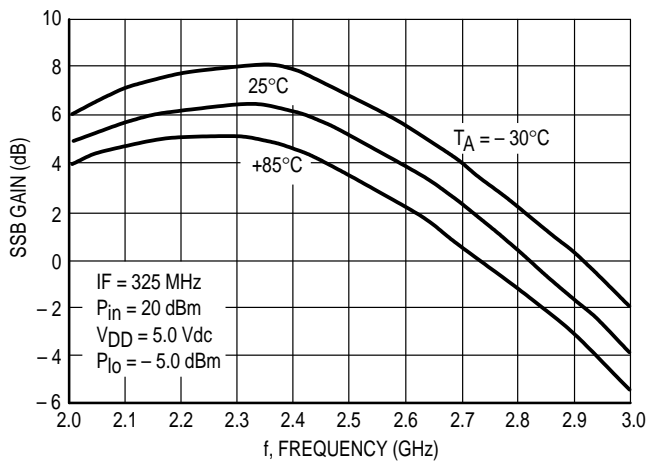

Figure 7. Mixer Conversion Gain versus Frequency

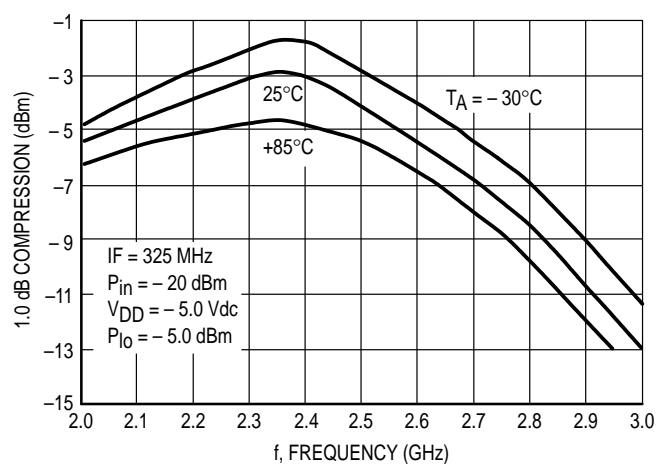

Figure 8. Mixer 1.0 dB Compression versus Frequency

TYPICAL CHARACTERISTICS

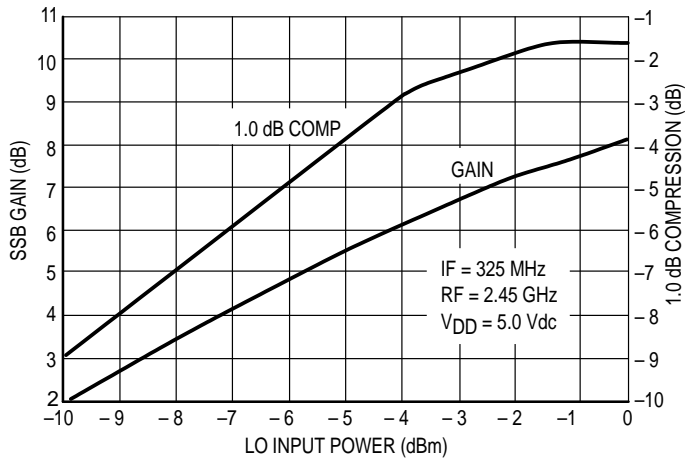

Figure 9. Mixer 1.0 dB Compression and Gain versus LO Power

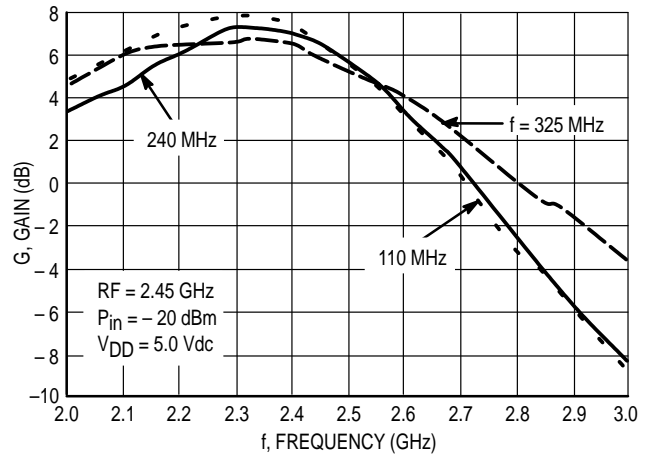

Figure 10. Mixer Gain versus Frequency

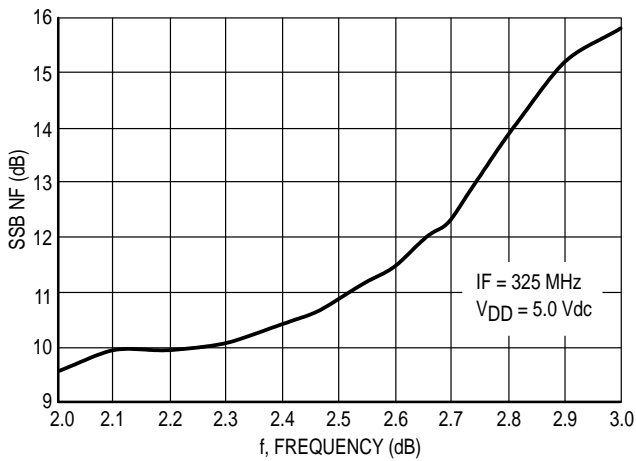

Figure 11. Mixer Noise Figure versus Frequency

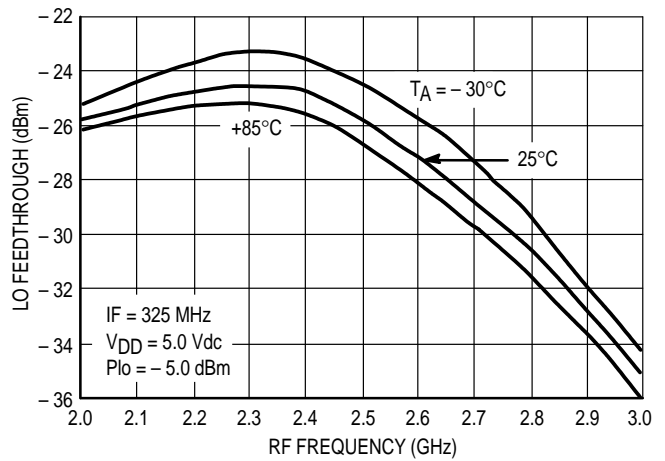

Figure 12. Mixer LO Feedthrough versus RF Frequency

DESIGN AND APPLICATIONS INFORMATION

The MRFIC2401 consists of a two-stage GaAs MESFET low noise amplifier and a single ended MESFET mixer. The LNA design conserves bias current through stacking of the two FETs, thus reusing the current. The mixer consists of a common gate stage driving a common source stage with the IF output being the drain of the common source stage shunted with 15 pF. The LNA output and mixer input have been separated to allow the addition of an external image filter. Such a filter, usually ceramic, is useful in improving the mixer noise figure and third order intercept performance. It also provides LO rejection to reduce the amount of LO power which may leak to the antenna. Alternatively, image trapping can be implemented at the LNA input or output with discrete or distributed components.

The design has been optimized for best performance from 2.4 to 2.5 GHz, but the device is usable with reduced performance from 2.0 to 3.0 GHz as shown in the performance curves. These curves were generated using the circuit shown in Figure 1 and performance above 2.5 GHz can be enhanced by rematching the LO input port. Matching circuit details are shown for IFs of 110 MHz, 240 MHz, and 325 MHz matched to 50 Ω and LO frequencies consistent with an RF frequency of 2.45 GHz. Customized IF matching can be accomplished by using the Equivalent IF Output circuit model shown in Figure 2. The best gain/noise figure

tradeoff match is shown in the LNA input impedance column of Table 1. The LO input impedance is shown in the same table. These numbers are derived from conjugate match measurements of the applications circuit. The LNA output and mixer input are matched to 50 Ω .

As with all RF circuitry, layout is important. Controlled impedance lines should be used at all RF ports. RF bypassing of power supply connections as close to the part as possible, while not always shown in the applications circuit, are recommended. Additional power supply "stiffening" and digital transient bypassing should be accomplished with electrolytic or tantalum capacitors.

The device can be placed in a reduced current "standby" mode by applying 5.0 Vdc to the STANDBY pin and removing the LO drive. Further current reduction "sleep" mode, is enabled by applying 0 Vdc to V_{DD}/SLEEP. This sleep mode can also be used to disable the LNA under high signal level conditions and give higher input intercept point if V_{DD} is still applied to the mixer.

EVALUATION BOARDS

Evaluation boards are available for RF Monolithic Integrated Circuits by adding a "TF" suffix to the device type. For a complete list of currently available boards and ones in development for newly introduced product, please contact your local Motorola Distributor or Sales Office.

PACKAGE DIMENSIONS

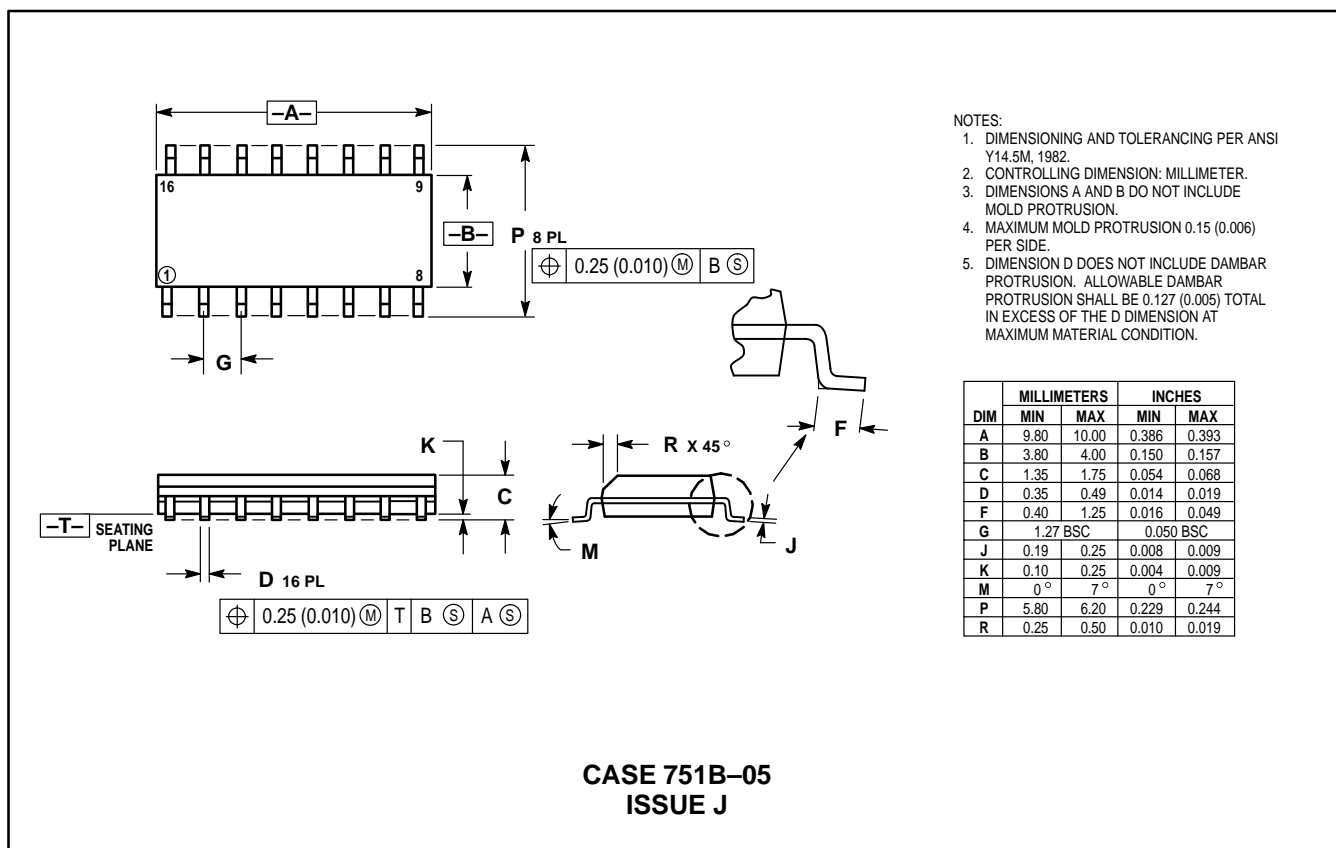

- NOTES:
1. DIMENSIONING AND TOLERANCING PER ANSI Y14.5M, 1982.
 2. CONTROLLING DIMENSION: MILLIMETER.
 3. DIMENSIONS A AND B DO NOT INCLUDE MOLD PROTRUSION.
 4. MAXIMUM MOLD PROTRUSION 0.15 (0.006) PER SIDE.
 5. DIMENSION D DOES NOT INCLUDE DAMBAR PROTRUSION. ALLOWABLE DAMBAR PROTRUSION SHALL BE 0.127 (0.005) TOTAL IN EXCESS OF THE D DIMENSION AT MAXIMUM MATERIAL CONDITION.

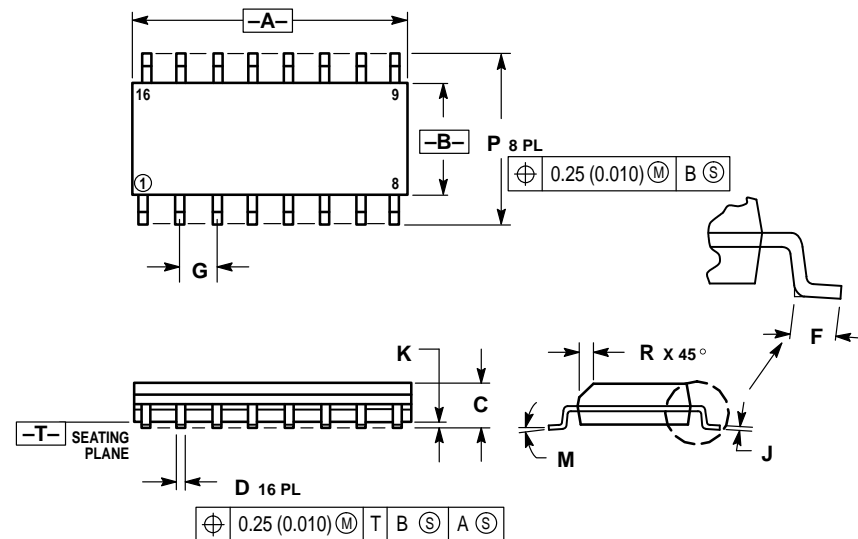

Motorola reserves the right to make changes without further notice to any products herein. Motorola makes no warranty, representation or guarantee regarding the suitability of its products for any particular purpose, nor does Motorola assume any liability arising out of the application or use of any product or circuit, and specifically disclaims any and all liability, including without limitation consequential or incidental damages. "Typical" parameters can and do vary in different applications. All operating parameters, including "Typicals" must be validated for each customer application by customer's technical experts. Motorola does not convey any license under its patent rights nor the rights of others. Motorola products are not designed, intended, or authorized for use as components in systems intended for surgical implant into the body, or other applications intended to support or sustain life, or for any other application in which the failure of the Motorola product could create a situation where personal injury or death may occur. Should Buyer purchase or use Motorola products for any such unintended or unauthorized application, Buyer shall indemnify and hold Motorola and its officers, employees, subsidiaries, affiliates, and distributors harmless against all claims, costs, damages, and expenses, and reasonable attorney fees arising out of, directly or indirectly, any claim of personal injury or death associated with such unintended or unauthorized use, even if such claim alleges that Motorola was negligent regarding the design or manufacture of the part. Motorola and (M) are registered trademarks of Motorola, Inc. Motorola, Inc. is an Equal Opportunity/Affirmative Action Employer.

How to reach us:
USA / EUROPE: Motorola Literature Distribution;
 P.O. Box 20912; Phoenix, Arizona 85036. 1-800-441-2447

JAPAN: Nippon Motorola Ltd.; Tatsumi-SPD-JLDC, Toshikatsu Otsuki,
 6F Seibu-Butsuryu-Center, 3-14-2 Tatsumi Koto-Ku, Tokyo 135, Japan. 03-3521-8315

MFAX: RMFAX0@email.sps.mot.com - TOUCHTONE (602) 244-6609
INTERNET: http://Design-NET.com

HONG KONG: Motorola Semiconductors H.K. Ltd.; 8B Tai Ping Industrial Park,
 51 Ting Kok Road, Tai Po, N.T., Hong Kong. 852-26629298



MRFIC2401/D

