

Specifications

Parameter	Unit	Minimum	Typical	Maximum
Center Frequency	MHz	69.88	70	70.12
Insertion Loss	dB	—	12.5	14
1 dB Bandwidth	MHz	2	2.05	—
3 dB Bandwidth	MHz	2.5	2.6	—
40 dB Bandwidth	MHz	—	4.67	5.5
Passband Variation	dB	—	0.5	1.0
Group Delay Variation($f_0 \pm 0.7\text{MHz}$)	nsec	—	150	400
Phase Linearity ($f_0 \pm 0.7\text{MHz}$)	deg	—	12	—
Absolute Delay	usec	—	1.37	—
Ultimate Rejection	dB	40	45	—
Material Temperature coefficient	KHz/°C	-1.26		
Ambient Temperature	°C	25		
Package Size	SMP-53C (13.3x6.5mm Nominal Footprint)			

Notes:

1. All specifications are based on the test circuit shown
2. In production, devices will be tested at room temperature to a guardbanded specification to ensure electrical compliance over temperature
3. Electrical margin has been built into the design to account for the variations due to temperature drift and manufacturing tolerances
4. This is the optimum impedance in order to achieve the performance show

Matching Configuration

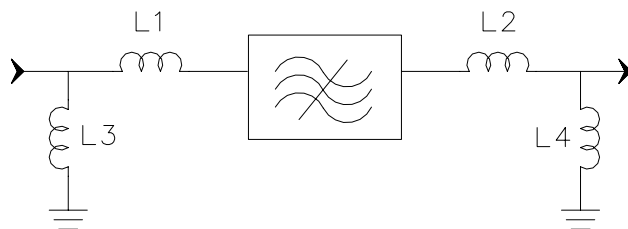

L1=120nH L2=100nH
L3=68nH L4=120nH
Source/Load Impedance=50 ohm

Notes - Component values may change depending on board layout.

	SIPAT Co., Ltd. (CETC No. 26 Research Institute) Nanping Huayuan Road No. 14 Chongqing, China, 400060	Part Number	LB070DS05	
		Rev. Date	2005-9-28	
		Rev.	1.0	Page

Package Dimension

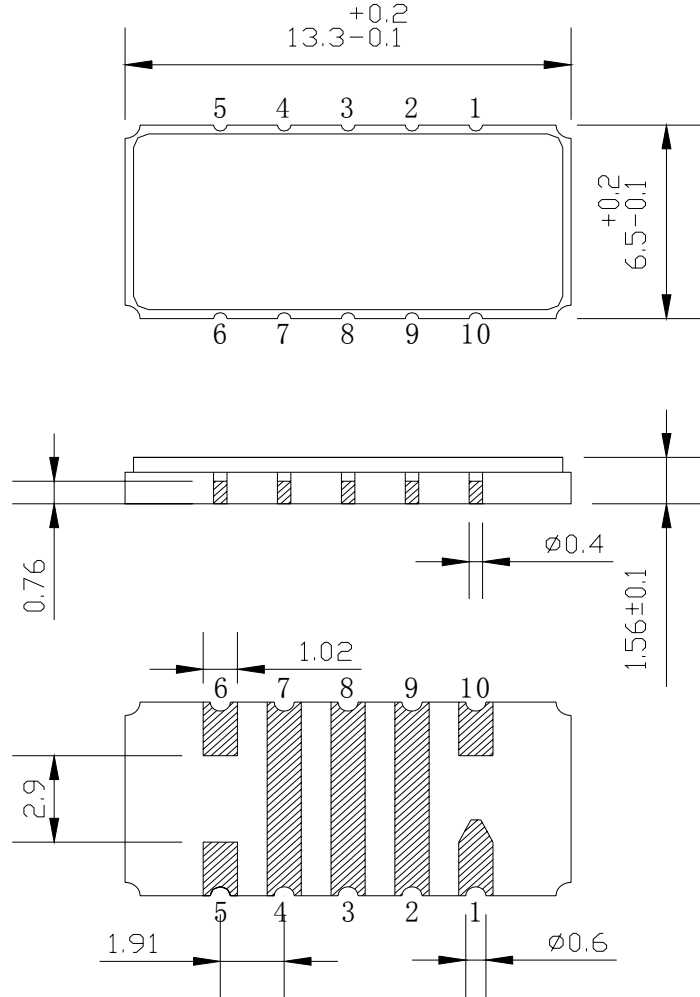

Input:10
Output:5



SIPAT Co., Ltd.
(CETC No. 26 Research Institute)
Nanping Huayuan Road No. 14
Chongqing, China, 400060

Part Number	LB070DS05	
Rev. Date	2005-9-28	
Rev.	1.0	Page 2/3

Typical Performance

Frequency Response

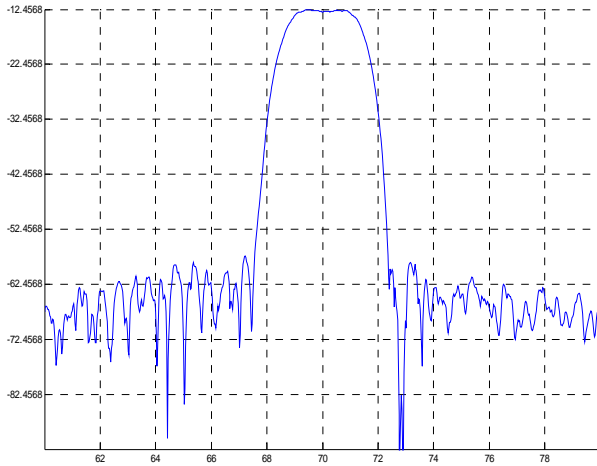

Passband Response

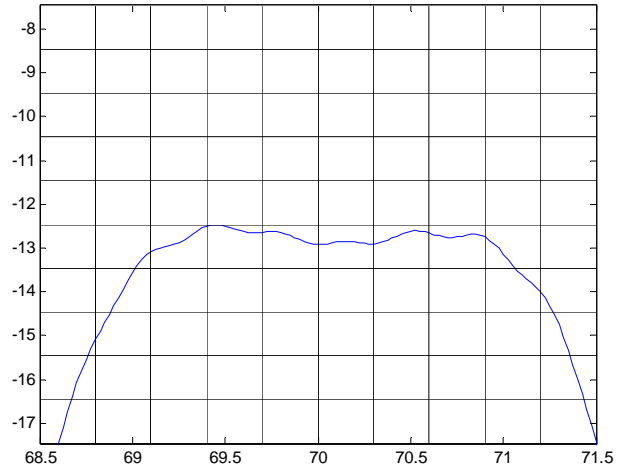

Phase Linearity($f_0 \pm 1.4\text{MHz}$)

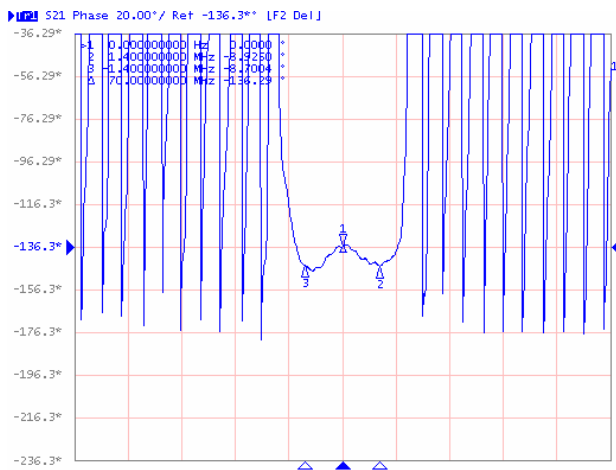

Group delay Variation($f_0 \pm 1.4\text{MHz}$)

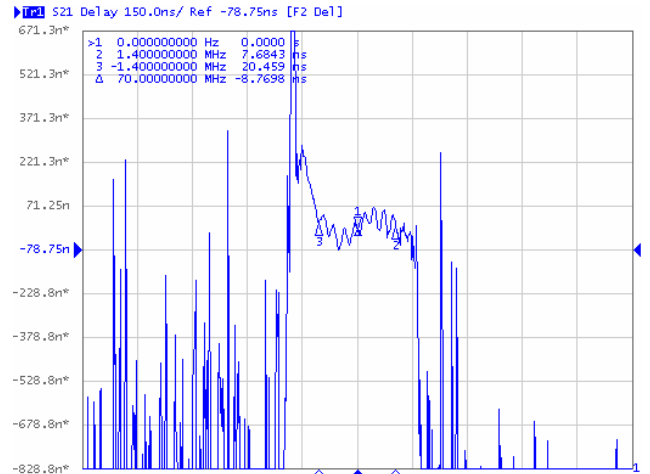

Smith Chart S11

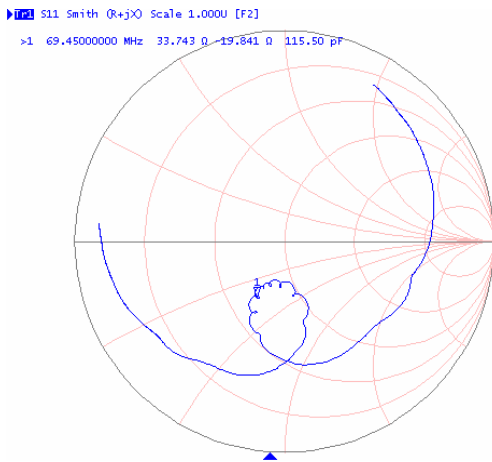

Smith Chart S22

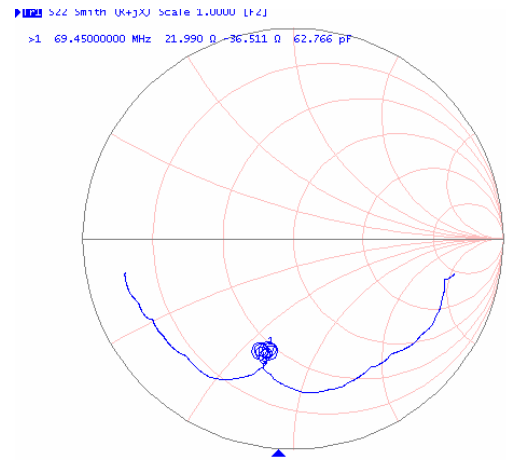

SIPAT Co., Ltd.
(CETC No. 26 Research Institute)
Nanping Huayuan Road No. 14
Chongqing, China, 400060

Part Number	LB070DS05	
Rev. Date	2005-9-28	
Rev.	1.0	Page 3/3