

## Resistor LED for 5 V Supply Voltage

Color	Type	Technology	Angle of Half Intensity $\pm\varphi$
High efficiency red	TLRH4450	GaAsP on GaP	30°
Yellow	TLRY4450	GaAsP on GaP	30°
Green	TLRG4450	GaP on GaP	30°

### Description

These devices are developed for applications with 5 V sources.

The TLR.445. series contains an integrated resistor for current limiting in series with the LED chip. This allows the lamp to be driven from a 5 V source without an external current limiter.

Available colors are red, high efficiency red, yellow and green. The luminous intensity of such an LED is measured at constant voltage of 5 V.

These tinted diffused lamps provide a wide off-axis viewing angle.

These LEDs are intended for space critical applications such as portable sets, switches and others which are driven from a 5 V source.

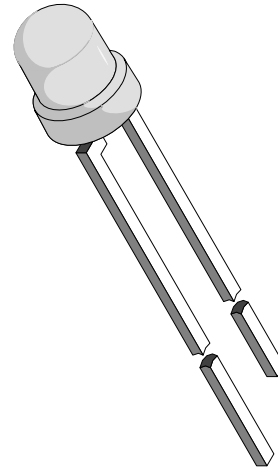

94 8488

### Features

- With current limiting resistor for 5 V
- TTL compatible
- Cost effective: save space and resistor cost
- Standard  $\varnothing$  3 mm (T-1) package
- Wide viewing angle
- Luminous intensity categorized
- Yellow and green color categorized
- Luminous intensity and color are measured at 5 V

### Applications

Status lights in portable applications

Status lights in space constrained applications

Background illumination for switches with 5 V source

Off / On indicator in switches with 5 V source

## Absolute Maximum Ratings

$T_{amb} = 25^{\circ}\text{C}$ , unless otherwise specified

TLRH4450 , TLR4450 , TLRG4450 ,

Parameter	Test Conditions	Symbol	Value	Unit
Reverse voltage		$V_R$	6	V
Forward voltage	$T_{amb} \leq 65^{\circ}\text{C}$	$V_F$	7.5	V
Power dissipation	$T_{amb} \leq 65^{\circ}\text{C}$	$P_V$	240	mW
Junction temperature		$T_j$	100	$^{\circ}\text{C}$
Storage temperature range		$T_{stg}$	-55 to +100	$^{\circ}\text{C}$
Soldering temperature	$t \leq 5\text{ s}$ , 2 mm from body	$T_{sd}$	260	$^{\circ}\text{C}$
Thermal resistance junction/ambient		$R_{thJA}$	150	K/W

## Optical and Electrical Characteristics

$T_{amb} = 25^{\circ}\text{C}$ , unless otherwise specified

High efficiency red (TLRH4450 )

Parameter	Test Conditions	Type	Symbol	Min	Typ	Max	Unit
Luminous intensity	$V_F = 5\text{ V}$		$I_V$	1.6	4		mcd
Dominant wavelength	$V_F = 5\text{ V}$		$\lambda_d$	612		625	nm
Peak wavelength	$V_F = 5\text{ V}$		$\lambda_p$		635		nm
Angle of half intensity	$V_F = 5\text{ V}$		$\phi$		$\pm 30$		deg
Forward current	$V_S = 5\text{ V}$		$I_F$		10	15	mA
Breakdown voltage	$I_R = 10\text{ }\mu\text{A}$		$V_{BR}$	6	20		V
Junction capacitance	$V_R = 0$ , $f = 1\text{ MHz}$		$C_j$		50		pF

Yellow (TLRY4450 )

Parameter	Test Conditions	Type	Symbol	Min	Typ	Max	Unit
Luminous intensity	$V_F = 5\text{ V}$		$I_V$	1.6	4		mcd
Dominant wavelength	$V_F = 5\text{ V}$		$\lambda_d$	581		594	nm
Peak wavelength	$V_F = 5\text{ V}$		$\lambda_p$		585		nm
Angle of half intensity	$V_F = 5\text{ V}$		$\phi$		$\pm 30$		deg
Forward current	$V_S = 5\text{ V}$		$I_F$		10	15	mA
Breakdown voltage	$I_R = 10\text{ }\mu\text{A}$		$V_{BR}$	6	20		V
Junction capacitance	$V_R = 0$ , $f = 1\text{ MHz}$		$C_j$		50		pF

Green (TLRG4450 )

Parameter	Test Conditions	Type	Symbol	Min	Typ	Max	Unit
Luminous intensity	$V_F = 5\text{ V}$		$I_V$	1.6	4		mcd
Dominant wavelength	$V_F = 5\text{ V}$		$\lambda_d$	562		575	nm
Peak wavelength	$V_F = 5\text{ V}$		$\lambda_p$		565		nm
Angle of half intensity	$V_F = 5\text{ V}$		$\phi$		$\pm 30$		deg
Forward current	$V_S = 5\text{ V}$		$I_F$		10	15	mA
Breakdown voltage	$I_R = 10\text{ }\mu\text{A}$		$V_{BR}$	6	20		V
Junction capacitance	$V_R = 0$ , $f = 1\text{ MHz}$		$C_j$		50		pF

**Typical Characteristics** ( $T_{amb} = 25^{\circ}\text{C}$ , unless otherwise specified)

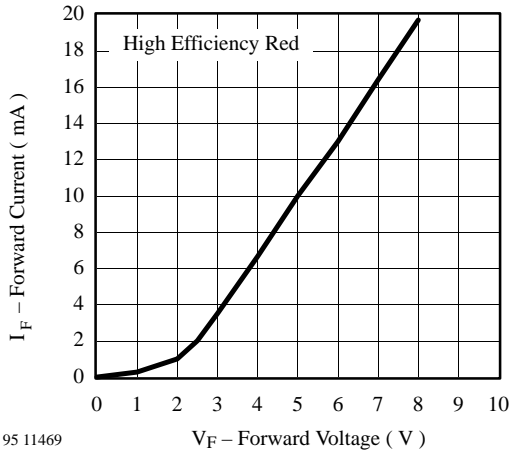

95 11469

Figure 1 Forward Current vs. Forward Voltage

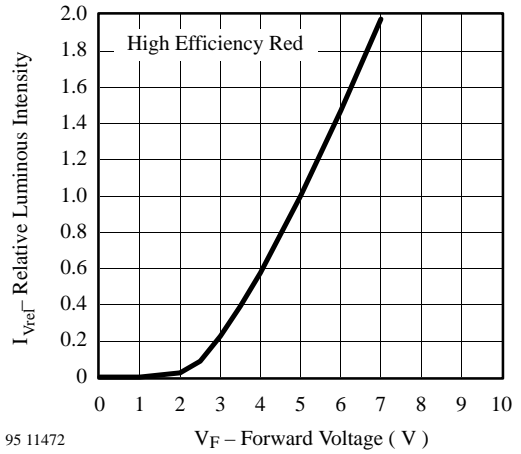

95 11472

Figure 4 Relative Luminous Intensity vs. Forward Voltage

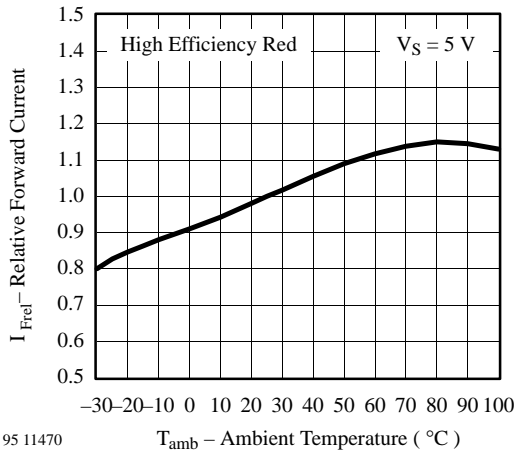

95 11470

Figure 2 Relative Forward Current vs. Ambient Temperature

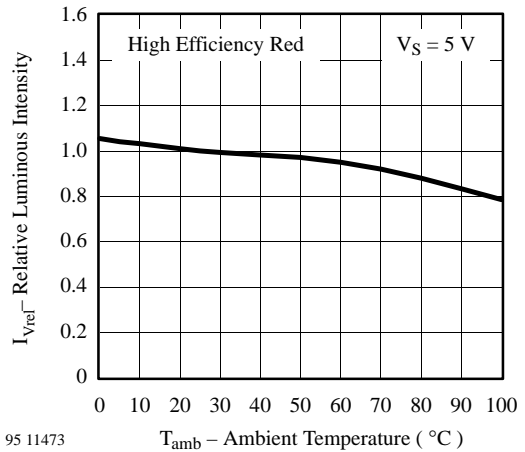

95 11473

Figure 5 Rel. Luminous Intensity vs. Ambient Temperature

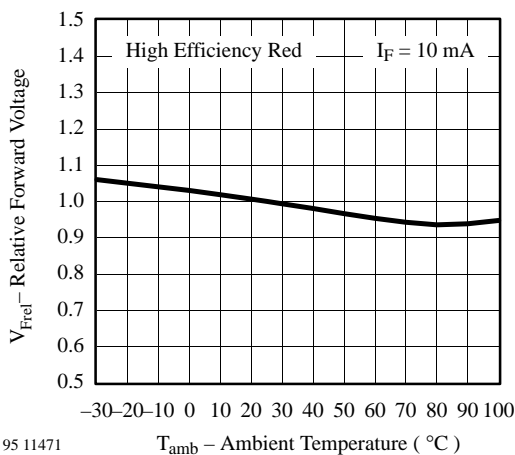

95 11471

Figure 3 Relative Forward Voltage vs. Ambient Temperature

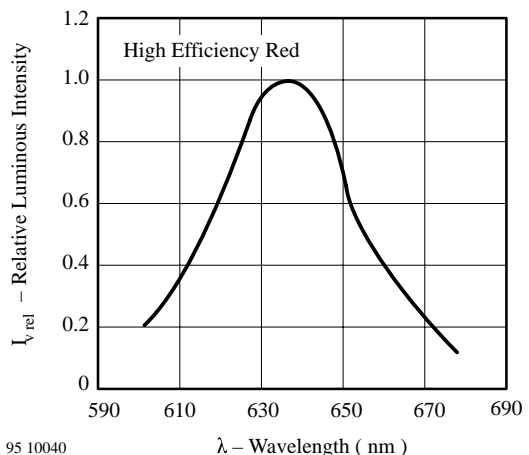

95 10040

Figure 6 Relative Luminous Intensity vs. Wavelength

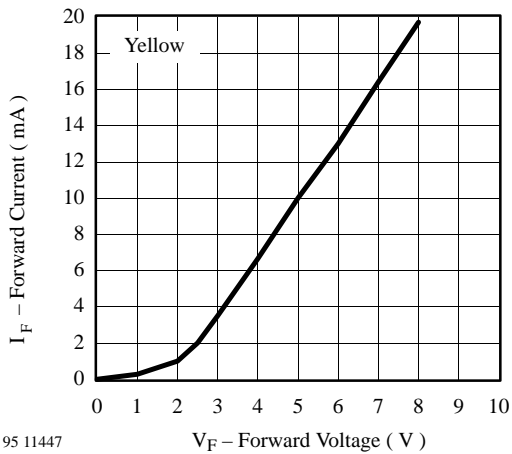

95 11447

Figure 7 Forward Current vs. Forward Voltage

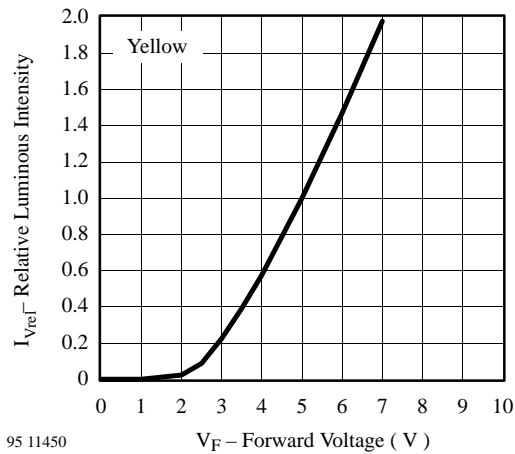

95 11450

Figure 10 Relative Luminous Intensity vs. Forward Voltage

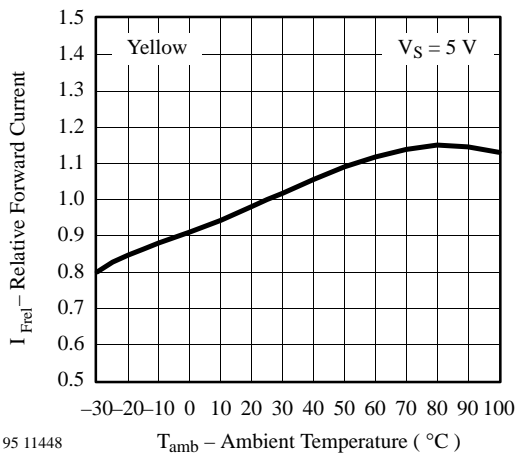

95 11448

Figure 8 Relative Forward Current vs. Ambient Temperature

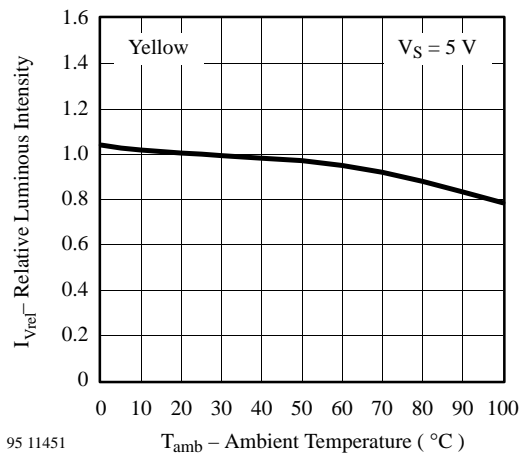

95 11451

Figure 11 Rel. Luminous Intensity vs. Ambient Temperature

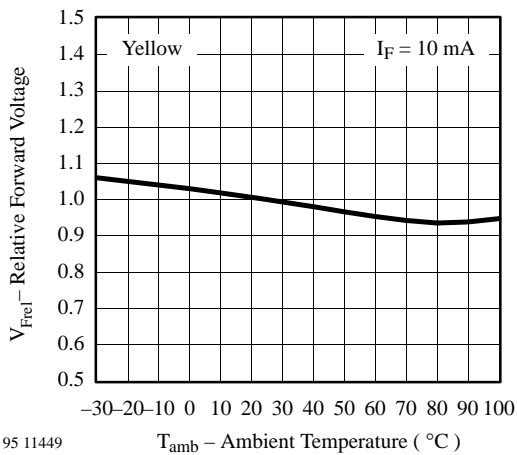

95 11449

Figure 9 Relative Forward Voltage vs. Ambient Temperature

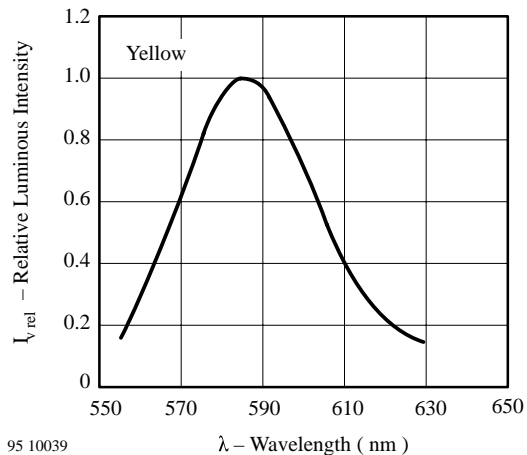

95 10039

Figure 12 Relative Luminous Intensity vs. Wavelength

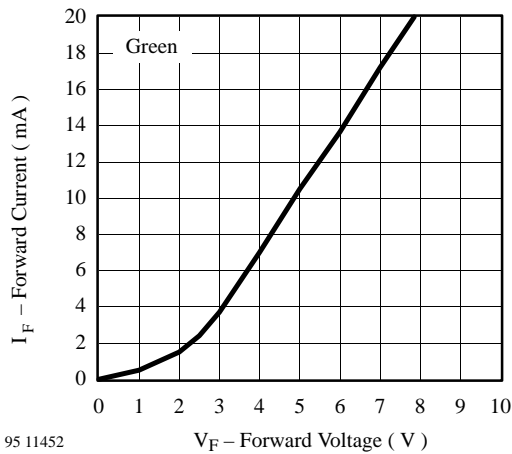

95 11452

Figure 13 Forward Current vs. Forward Voltage

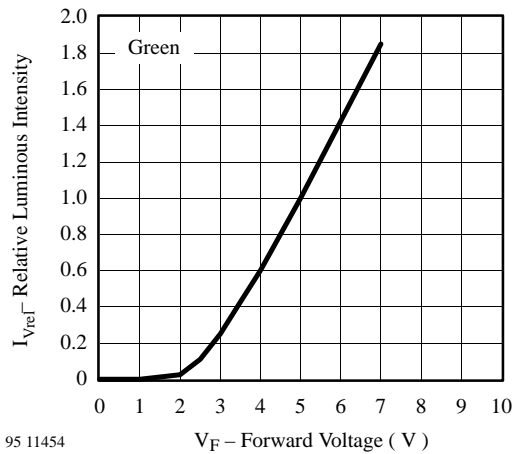

95 11454

Figure 16 Relative Luminous Intensity vs. Forward Voltage

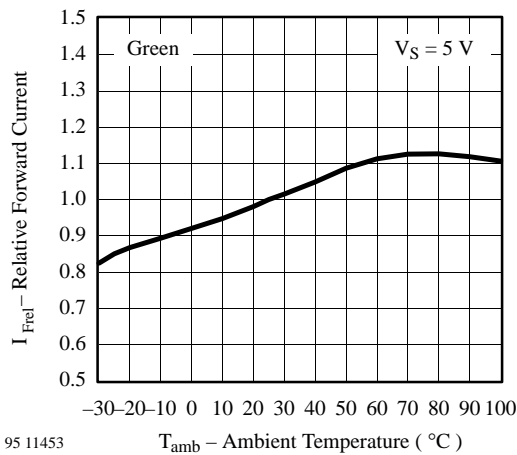

95 11453

Figure 14 Relative Forward Current vs. Ambient Temperature

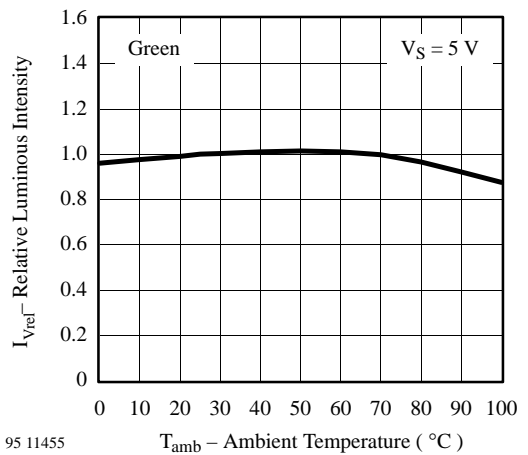

95 11455

Figure 17 Rel. Luminous Intensity vs. Ambient Temperature

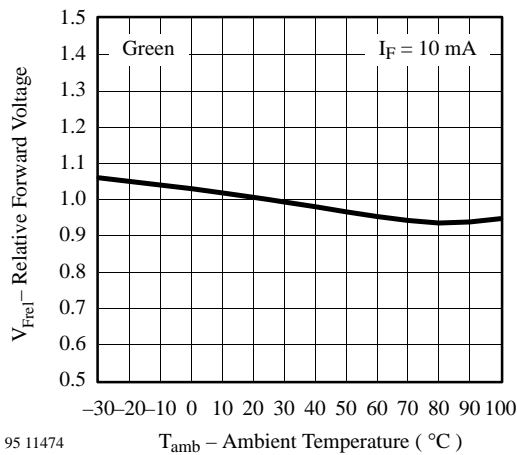

95 11474

Figure 15 Relative Luminous Intensity vs. Forward Voltage

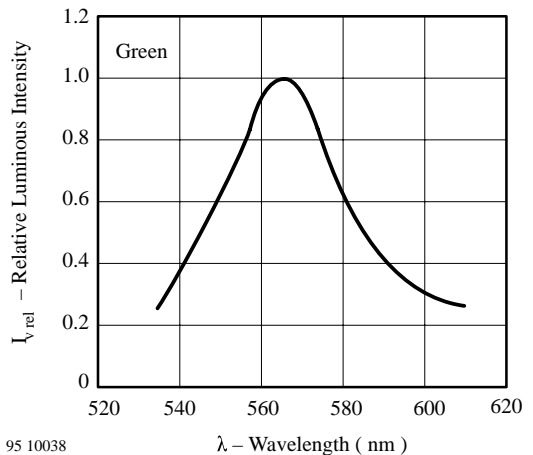

95 10038

Figure 18 Relative Luminous Intensity vs. Wavelength

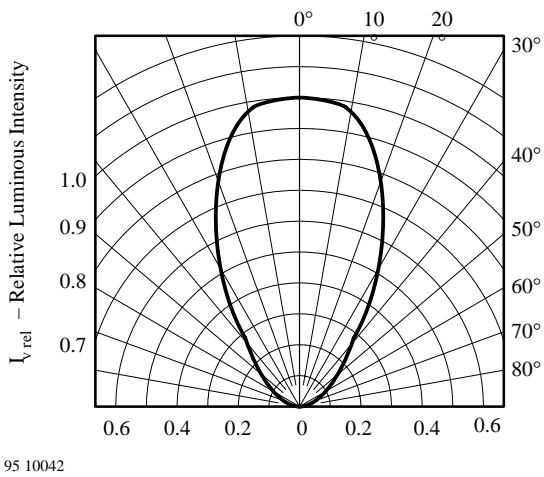
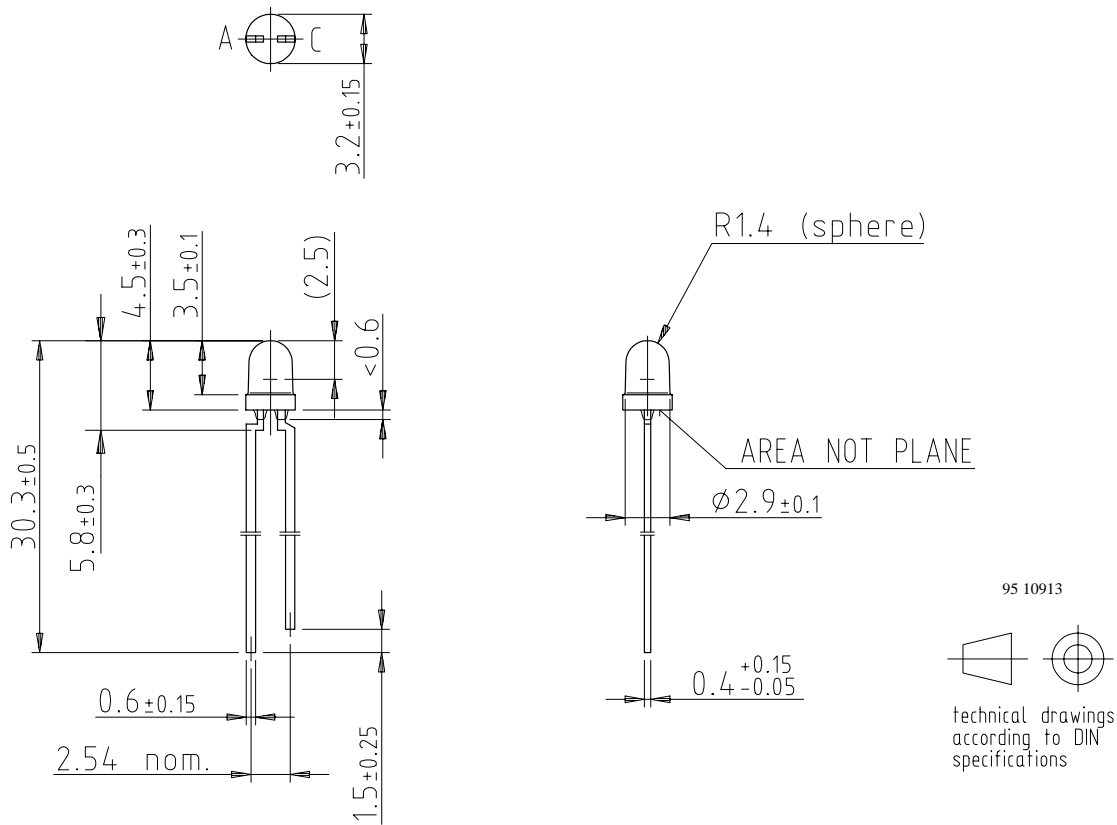

Figure 19 Rel. Luminous Intensity vs. Angular Displacement

Dimensions in mm





## Ozone Depleting Substances Policy Statement

It is the policy of **Vishay Semiconductor GmbH** to

1. Meet all present and future national and international statutory requirements.
2. Regularly and continuously improve the performance of our products, processes, distribution and operating systems with respect to their impact on the health and safety of our employees and the public, as well as their impact on the environment.

It is particular concern to control or eliminate releases of those substances into the atmosphere which are known as ozone depleting substances (ODSs).

The Montreal Protocol (1987) and its London Amendments (1990) intend to severely restrict the use of ODSs and forbid their use within the next ten years. Various national and international initiatives are pressing for an earlier ban on these substances.

**Vishay Semiconductor GmbH** has been able to use its policy of continuous improvements to eliminate the use of ODSs listed in the following documents.

1. Annex A, B and list of transitional substances of the Montreal Protocol and the London Amendments respectively
2. Class I and II ozone depleting substances in the Clean Air Act Amendments of 1990 by the Environmental Protection Agency (EPA) in the USA
3. Council Decision 88/540/EEC and 91/690/EEC Annex A, B and C (transitional substances) respectively.

**Vishay Semiconductor GmbH** can certify that our semiconductors are not manufactured with ozone depleting substances and do not contain such substances.

**We reserve the right to make changes to improve technical design and may do so without further notice.**

Parameters can vary in different applications. All operating parameters must be validated for each customer application by the customer. Should the buyer use Vishay-Telefunken products for any unintended or unauthorized application, the buyer shall indemnify Vishay-Telefunken against all claims, costs, damages, and expenses, arising out of, directly or indirectly, any claim of personal damage, injury or death associated with such unintended or unauthorized use.

Vishay Semiconductor GmbH, P.O.B. 3535, D-74025 Heilbronn, Germany  
Telephone: 49 (0)7131 67 2831, Fax number: 49 (0)7131 67 2423