



BULD118D-1

HIGH VOLTAGE FAST-SWITCHING NPN POWER TRANSISTOR

- INTEGRATED ANTIPARALLEL COLLECTOR- EMITTER DIODE
- HIGH VOLTAGE CAPABILITY
- LOW SPREAD OF DYNAMIC PARAMETERS
- MINIMUM LOT-TO-LOT SPREAD FOR RELIABLE OPERATION
- VERY HIGH SWITCHING SPEED

APPLICATIONS:

- ELECTRONIC BALLASTS FOR FLUORESCENT LIGHTING
- FLYBACK AND FORWARD SINGLE TRANSISTOR LOW POWER CONVERTERS

DESCRIPTION

The device is manufactured using high voltage Multi Epitaxial Planar technology for high switching speeds and medium voltage capability.

It uses a Cellular Emitter structure with planar edge termination to enhance switching speeds while maintaining the wide RBSOA.

The device is designed for use in lighting applications and low cost switch-mode power supplies.

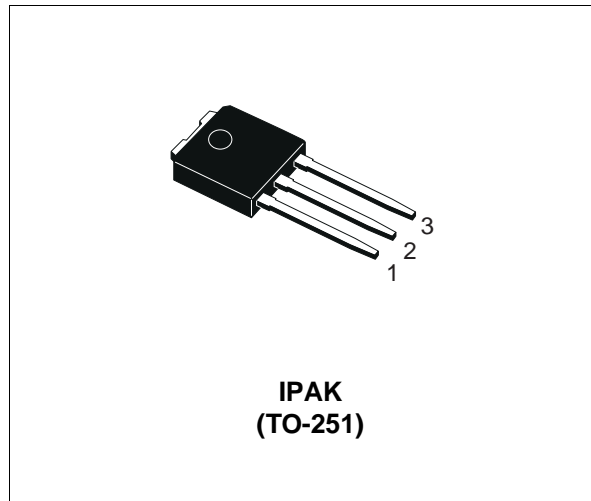

**IPAK
(TO-251)**

INTERNAL SCHEMATIC DIAGRAM

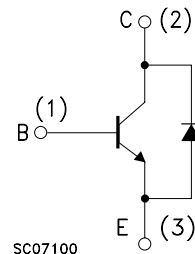

ABSOLUTE MAXIMUM RATINGS

Symbol	Parameter	Value	Unit
V_{CES}	Collector-Emitter Voltage ($V_{BE} = 0$)	700	V
V_{CEO}	Collector-Emitter Voltage ($I_B = 0$)	400	V
V_{EBO}	Emitter-Base Voltage ($I_C = 0$)	9	V
I_C	Collector Current	2	A
I_{CM}	Collector Peak Current ($t_p < 5$ ms)	4	A
I_B	Base Current	1	A
I_{BM}	Base Peak Current ($t_p < 5$ ms)	2	A
P_{tot}	Total Dissipation at $T_c = 25$ °C	20	W
T_{stg}	Storage Temperature	-65 to 150	°C
T_j	Max. Operating Junction Temperature	150	°C

BULD118D-1

THERMAL DATA

R _{thj-case}	Thermal Resistance Junction-Case	Max	6.25	°C/W
R _{thj-amb}	Thermal Resistance Junction-Ambient	Max	100	°C/W

ELECTRICAL CHARACTERISTICS (T_{case} = 25 °C unless otherwise specified)

Symbol	Parameter	Test Conditions	Min.	Typ.	Max.	Unit
I _{CES}	Collector Cut-off Current (V _{BE} = 0)	V _{CE} = 700 V V _{CE} = 700 V T _j = 125 °C			100 500	μA μA
V _{EBO}	Emitter-Base Voltage	I _E = 10 mA	9			V
V _{CEO(sus)}	Collector-Emitter Sustaining Voltage	I _C = 100 mA L = 25 mH	400			V
I _{CEO}	Collector-Emitter Leakage Current	V _{CE} = 400 V			250	μA
V _{CE(sat)*}	Collector-Emitter Saturation Voltage	I _C = 0.5 A I _B = 0.1 A I _C = 1 A I _B = 0.2 A I _C = 2 A I _B = 0.4 A			0.5 1 1.5	V V V
V _{BE(sat)*}	Base-Emitter Saturation Voltage	I _C = 0.5 A I _B = 0.1 A I _C = 1 A I _B = 0.2 A I _C = 2 A I _B = 0.4 A			1.0 1.2 1.3	V V V
h _{FE*}	DC Current Gain	I _C = 10 mA V _{CE} = 5 V I _C = 0.5 A V _{CE} = 5 V I _C = 2 A V _{CE} = 5 V	10 10 8		50	
t _r t _f t _s	RESISTIVE LOAD Rise Time Fall Time Storage Time group A group B	V _{CC} = 125 V I _C = 2 A I _{B1} = 0.4 A I _{B2} = -0.2 A t _p = 30 μs		0.7 0.3	0.5	μs μs
t _s t _f	INDUCTIVE LOAD Storage Time Fall Time	I _C = 1 A I _{B1} = 0.2 A V _{BE} = -5 V L = 50 mH V _{clamp} = 300 V		0.8 0.10		μs μs
V _F	Diode Forward Voltage	I _C = 1 A			2.5	V

* Pulsed: Pulse duration = 300 μs, duty cycle 1.5 %

Note : Product is pre-selected in storage time (GROUP A and GROUP B). STMicroelectronics reserves the right to ship either groups according to production availability. Please contact your nearest STMicroelectronics sales office for delivery details.

Safe Operating Areas

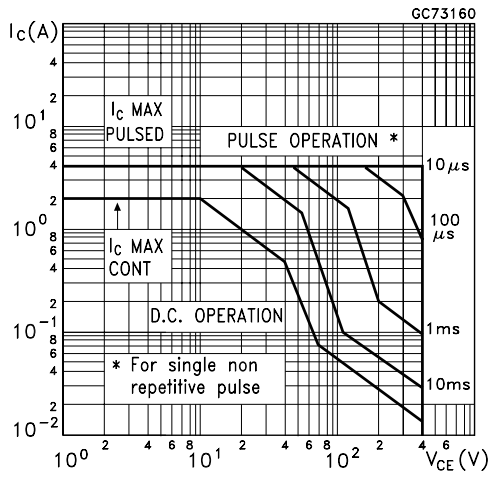

Derating Curve

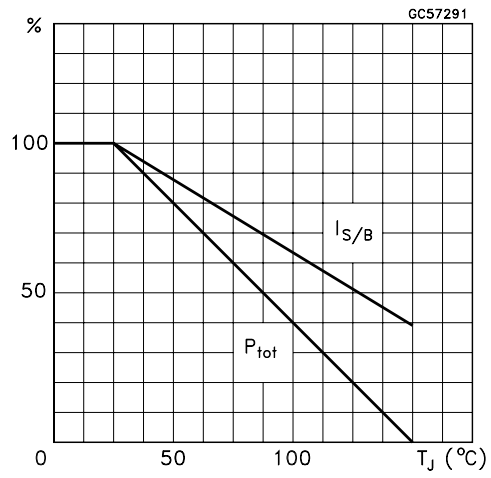

DC Current Gain

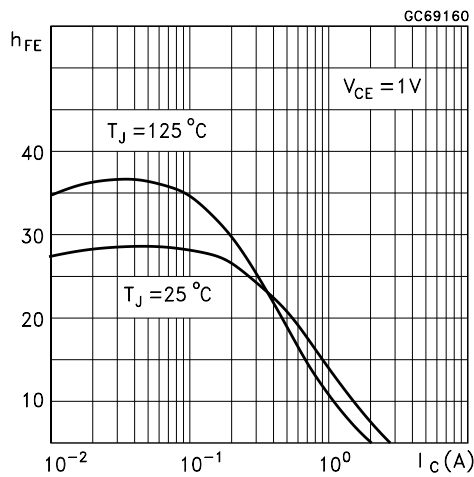

DC Current Gain

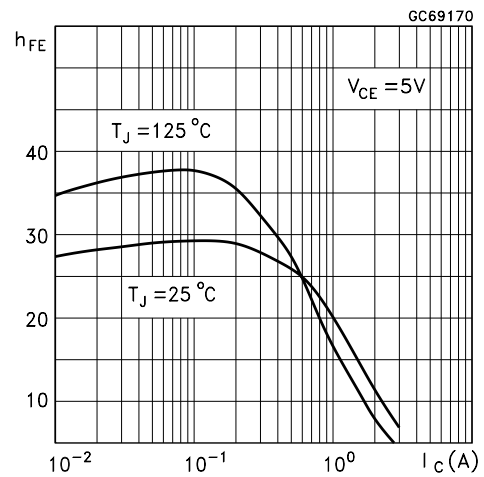

Collector Emitter Saturation Voltage

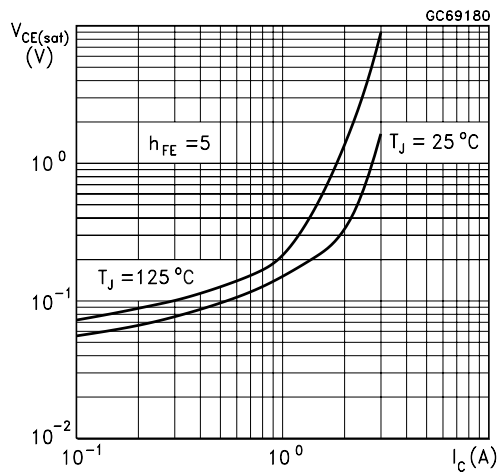

Base Emitter Saturation Voltage

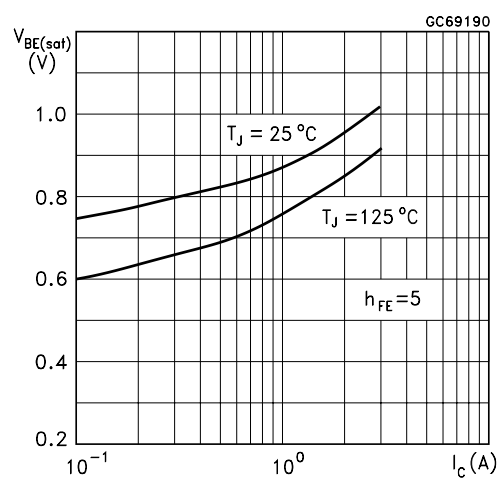

Inductive Fall Time

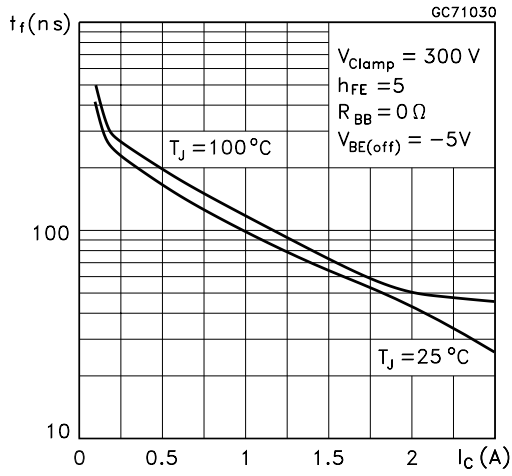

Inductive Storage Time

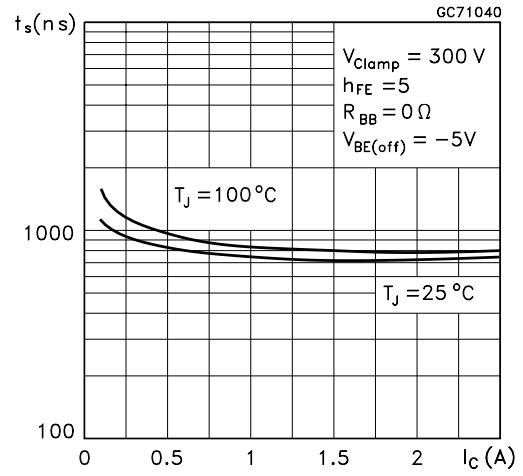

Resistive Fall Time

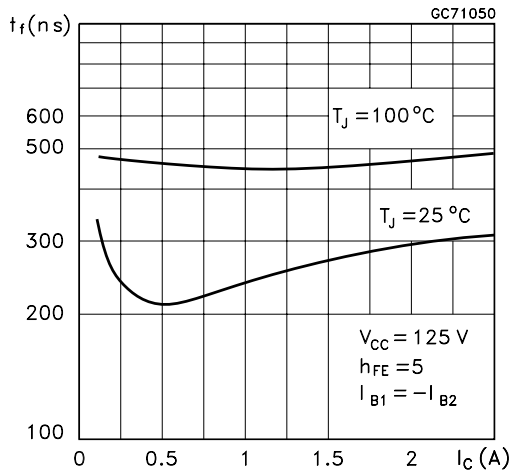

Resistive Load Storage Time

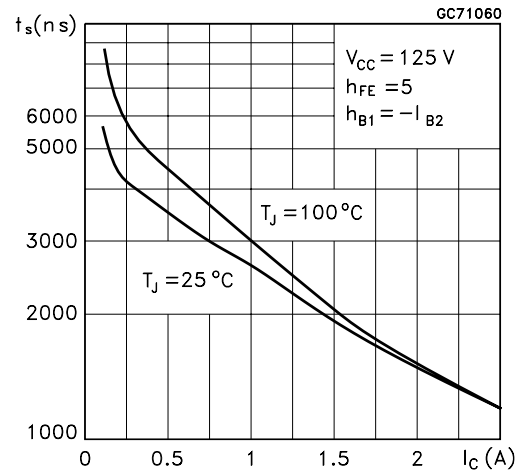

Reverse Biased SOA

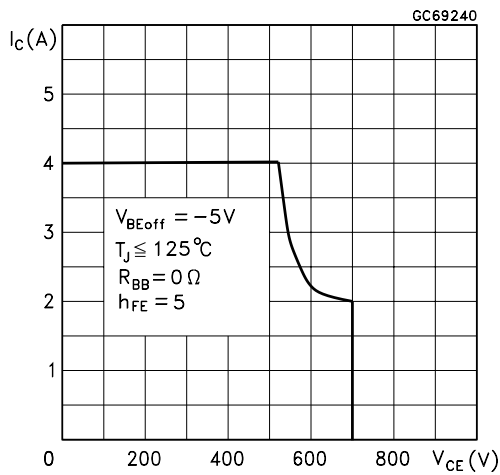

Figure 1: Inductive Load Switching Test Circuit.

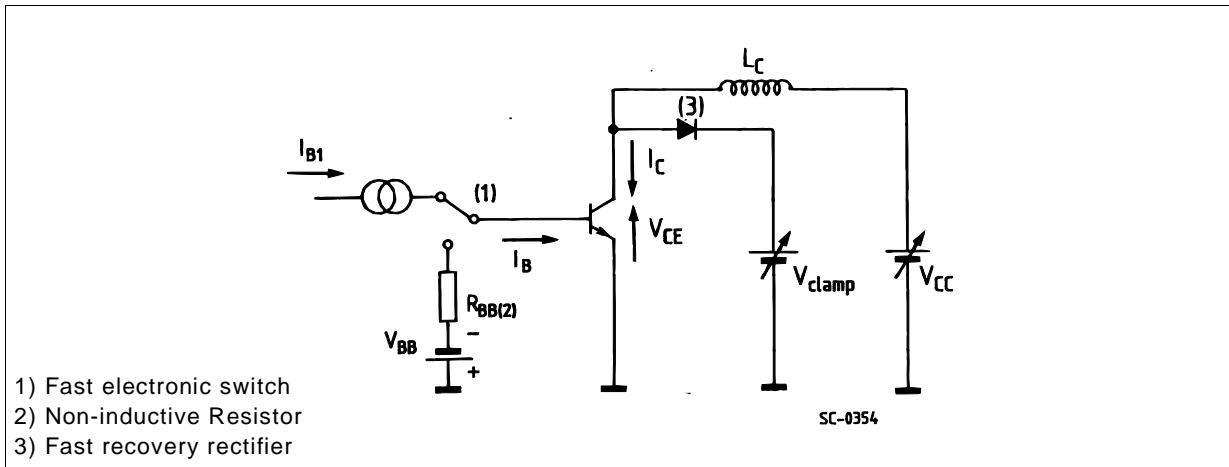
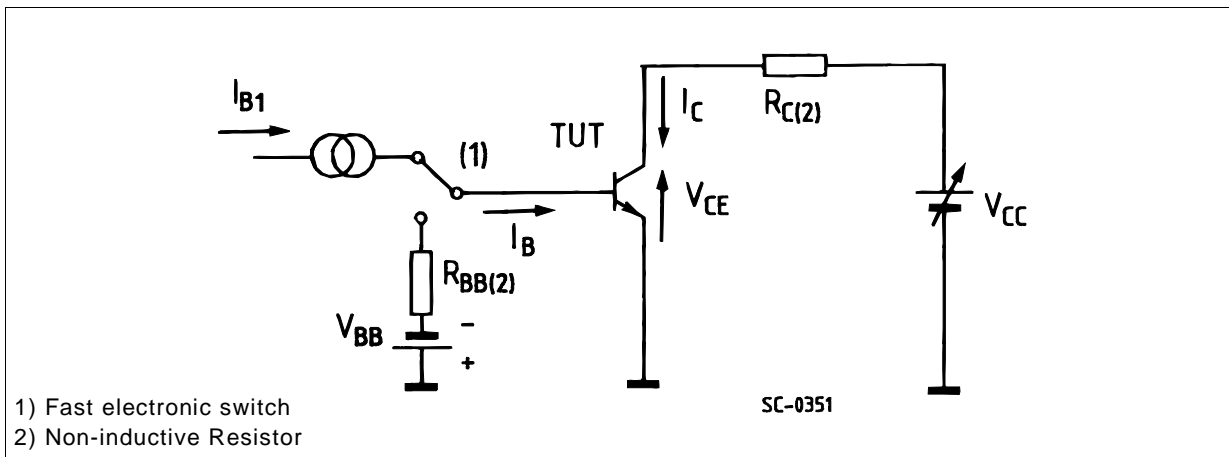
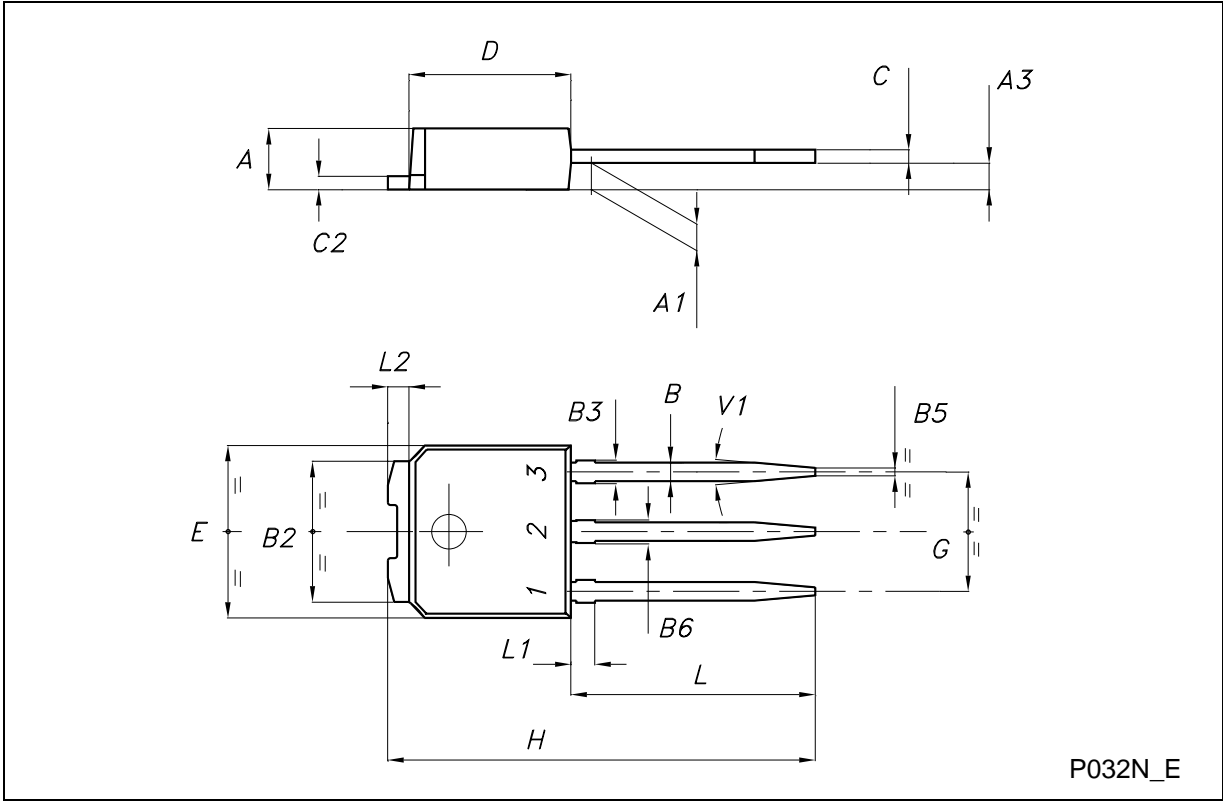

Figure 2: Resistive Load Switching Test Circuit.



TO-251 (IPAK) MECHANICAL DATA

DIM.	mm			inch		
	MIN.	TYP.	MAX.	MIN.	TYP.	MAX.
A	2.20		2.40	0.087		0.094
A1	0.90		1.10	0.035		0.043
A3	0.70		1.30	0.028		0.051
B	0.64		0.90	0.025		0.035
B2	5.20		5.40	0.204		0.213
B3			0.85			0.033
B5		0.30			0.012	
B6			0.95			0.037
C	0.45		0.60	0.018		0.024
C2	0.48		0.60	0.019		0.024
D	6.00		6.20	0.237		0.244
E	6.40		6.60	0.252		0.260
G	4.40		4.60	0.173		0.181
H	15.90		16.30	0.626		0.642
L	9.00		9.40	0.354		0.370
L1	0.80		1.20	0.031		0.047
L2		0.80	1.00		0.031	0.039
V1		10°			10°	



Information furnished is believed to be accurate and reliable. However, STMicroelectronics assumes no responsibility for the consequences of use of such information nor for any infringement of patents or other rights of third parties which may result from its use. No license is granted by implication or otherwise under any patent or patent rights of STMicroelectronics. Specification mentioned in this publication are subject to change without notice. This publication supersedes and replaces all information previously supplied. STMicroelectronics products are not authorized for use as critical components in life support devices or systems without express written approval of STMicroelectronics.

The ST logo is a trademark of STMicroelectronics

© 2001 STMicroelectronics – Printed in Italy – All Rights Reserved

STMicroelectronics GROUP OF COMPANIES

Australia - Brazil - China - Finland - France - Germany - Hong Kong - India - Italy - Japan - Malaysia - Malta - Morocco - Singapore - Spain - Sweden - Switzerland - United Kingdom - U.S.A.

<http://www.st.com>