



STGF7NB60SL

N-CHANNEL 7A - 600V - TO-220FP

PowerMESH™ IGBT

Table 1: General Features

TYPE	V _{CES}	V _{CE(sat)} (Max) @25°C	I _C @100°C
STGF7NB60SL	200 V	< 0.045 Ω	40 A

- POLYSILICON GATE VOLTAGE DRIVEN
- LOW THRESHOLD VOLTAGE
- LOW ON-VOLTAGE DROP
- LOW GATE CHARGE
- HIGH CURRENT CAPABILITY

DESCRIPTION

Using the latest high voltage technology based on a patented strip layout, STMicroelectronics has designed an advanced family of IGBTs, the PowerMESH™ IGBTs, with outstanding performances. The suffix "S" identifies a family optimized achieve minimum on-voltage drop for low frequency applications (<1kHz).

APPLICATIONS

- LIGHT DIMMER
- STATIC RELAYS

Figure 1: Package

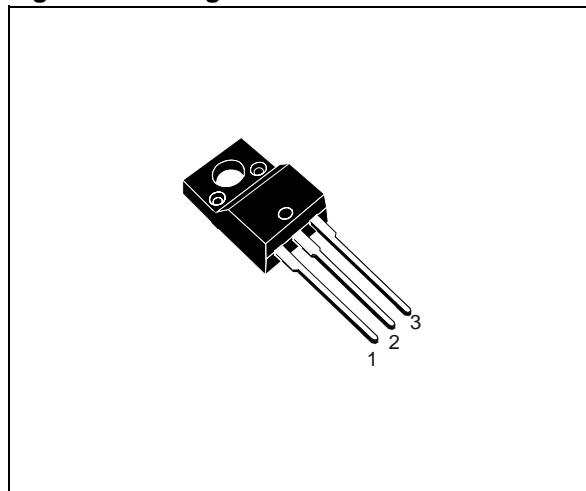

Figure 2: Internal Schematic Diagram

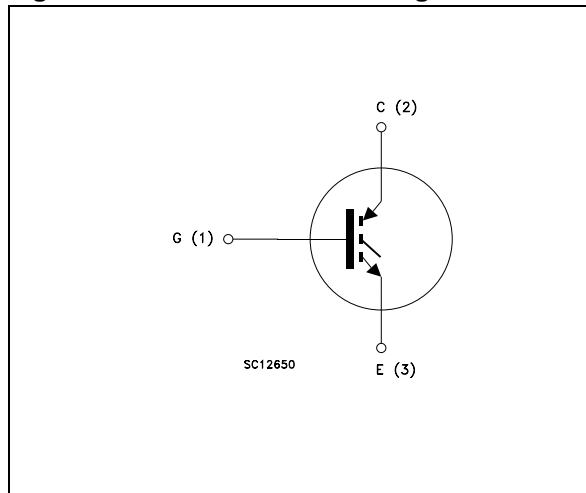

Table 2: Order Codes

SALES TYPE	MARKING	PACKAGE	PACKAGING
STGF7NB60SL	GF7NB60SL	TO-220FP	TUBE

Table 3: Absolute Maximum ratings

Symbol	Parameter	Value	Symbol
V_{CES}	Collector-Emitter Voltage ($V_{GS} = 0$)	600	V
V_{ECR}	Reverse Battery Protection	20	V
V_{GE}	Gate-Emitter Voltage	± 20	V
I_C	Collector Current (continuous) at 25°C	15	A
I_C	Collector Current (continuous) at 100°C	7	A
$I_{CM} (1)$	Collector Current (pulsed)	20	A
P_{TOT}	Total Dissipation at $T_C = 25^\circ\text{C}$	25	W
	Derating Factor	0.2	W/°C
V_{ISO}	Insulation Withstand Voltage A.C.	2500	V
T_{stg}	Storage Temperature	- 55 to 150	°C
T_j	Operating Junction Temperature		

(1)Pulse width limited by max. junction temperature.

Table 4: Thermal Data

Rthj-case	Thermal Resistance Junction-case Max	5	°C/W
Rthj-amb	Thermal Resistance Junction-ambient Max	62.5	°C/W

ELECTRICAL CHARACTERISTICS ($T_{CASE} = 25^\circ\text{C}$ UNLESS OTHERWISE SPECIFIED)**Table 5: Off**

Symbol	Parameter	Test Conditions	Min.	Typ.	Max.	Unit
$V_{BR(CES)}$	Collectro-Emitter Breakdown Voltage	$I_C = 250 \mu\text{A}$, $V_{GE} = 0$	600			V
$V_{BR(ECS)}$	Emitter-Collector Breakdown Voltage	$I_C = 1\text{mA}$, $V_{GE} = 0$	20			V
I_{CES}	Collector-Emitter Leakage Current ($V_{CE} = 0$)	$V_{GE} = \text{Max Rating}$ $T_C = 25^\circ\text{C}$ $T_C = 125^\circ\text{C}$			10 100	μA μA
I_{GES}	Gate-Emitter Leakage Current ($V_{CE} = 0$)	$V_{GE} = \pm 20 \text{ V}$, $V_{CE} = 0$			± 100	nA

Table 6: On

Symbol	Parameter	Test Conditions	Min.	Typ.	Max.	Unit
$V_{GE(th)}$	Gate Threshold Voltage	$V_{CE} = V_{GE}$, $I_C = 250 \mu\text{A}$	1.2		2.4	V
$V_{CE(SAT)}$	Collector-Emitter Saturation Voltage	$V_{GE} = 4.5 \text{ V}$, $I_C = 7\text{A}$, $T_j = 25^\circ\text{C}$ $V_{GE} = 4.5 \text{ V}$, $I_C = 7\text{A}$, $T_j = 125^\circ\text{C}$		1.2 1.1	1.6	V V

ELECTRICAL CHARACTERISTICS (CONTINUED)

Table 7: Dynamic

Symbol	Parameter	Test Conditions	Min.	Typ.	Max.	Unit
g_{fs}	Forward Transconductance	$V_{CE} = 15 \text{ V}$, $I_C = 7 \text{ A}$		5		S
C_{ies} C_{oes} C_{res}	Input Capacitance Output Capacitance Reverse Transfer Capacitance	$V_{CE} = 25 \text{ V}$, $f = 1 \text{ MHz}$, $V_{GE} = 0$		800 60 10		pF pF pF
Q_g Q_{ge} Q_{gc}	Total Gate Charge Gate-Emitter Charge Gate-Collector Charge	$V_{CE} = 480 \text{ V}$, $I_C = 7 \text{ A}$, $V_{GE} = 5 \text{ V}$ (see Figure 20)		16 2.5 8.5	22	nC nC nC
I_{CL}	Turn-Off SOA Minimum Current	$V_{clamp} = 480 \text{ V}$, $T_j = 125^\circ\text{C}$ $R_G = 1 \text{ K}\Omega$, $V_{GE} = 5 \text{ V}$	20			A
t_{scw}	Short Circuit Withstand Time	$V_{ce} = 0.5 V_{BR(CES)}$, $V_{GE} = 5 \text{ V}$, $T_j = 125^\circ\text{C}$, $R_G = 1 \text{ K}\Omega$		14		μs

Table 8: Switching On

Symbol	Parameter	Test Conditions	Min.	Typ.	Max.	Unit
$t_{d(on)}$ t_r	Turn-on Delay Time Current Rise Time	$V_{CC} = 480 \text{ V}$, $I_C = 7 \text{ A}$ $R_G = 1 \text{ K}\Omega$, $V_{GE} = 5 \text{ V}$ (see Figure 18)		1.1 0.25		μs μs
$(di/dt)_{on}$ E_{on}	Turn-on Current Slope Turn-on Switching Losses	$V_{CC} = 480 \text{ V}$, $I_C = 7 \text{ A}$ $R_G = 1 \text{ K}\Omega$ $V_{GE} = 5 \text{ V}$, $T_j = 125^\circ\text{C}$		45 2.7		A/ μs mJ

Table 9: Switching Off

Symbol	Parameter	Test Conditions	Min.	Typ.	Max.	Unit
t_c $t_r(V_{off})$ $t_{d(off)}$ t_f $E_{off(**)}$	Cross-over Time Off Voltage Rise Time Delay Time Current Fall Time Turn-off Switching Loss	$V_{CC} = 480 \text{ V}$, $I_C = 7 \text{ A}$, $R_{GE} = 1 \text{ K}\Omega$, $V_{GE} = 5 \text{ V}$ (see Figure 18)		2.7 1.6 5.2 1.1 4.1		μs μs μs μs mJ
t_c $t_r(V_{off})$ $t_{d(off)}$ t_f $E_{off(**)}$	Cross-over Time Off Voltage Rise Time Delay Time Fall Time Turn-off Switching Loss	$V_{CC} = 480 \text{ V}$, $I_C = 7 \text{ A}$, $R_{GE} = 1 \text{ K}\Omega$, $V_{GE} = 5 \text{ V}$ $T_j = 125^\circ\text{C}$ (see Figure 18)		4.4 2.4 6.4 1.7 7.1		μs μs μs μs mJ

(**)Turn-off losses include also the tail of the collector current.

Figure 3: Output Characteristics

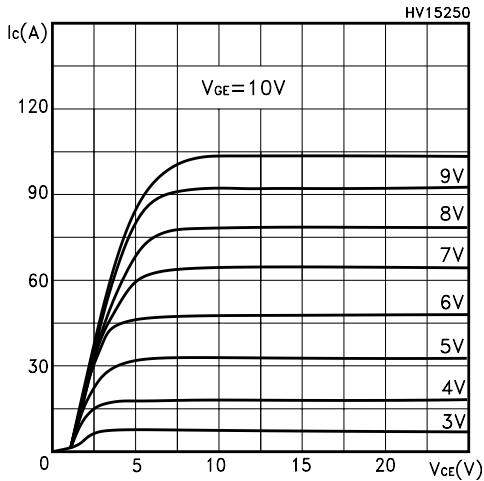

Figure 4: Transconductance

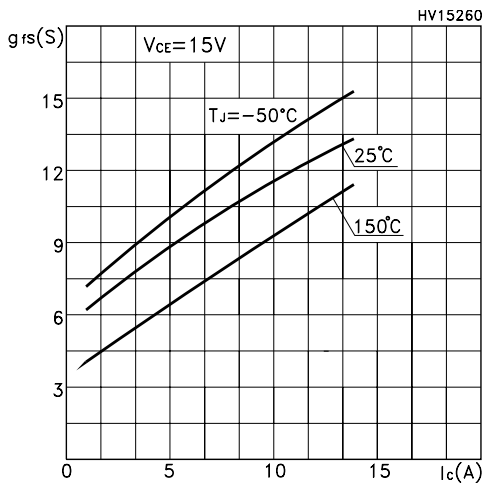

Figure 5: Collector-Emitter On Voltage vs Collector Current

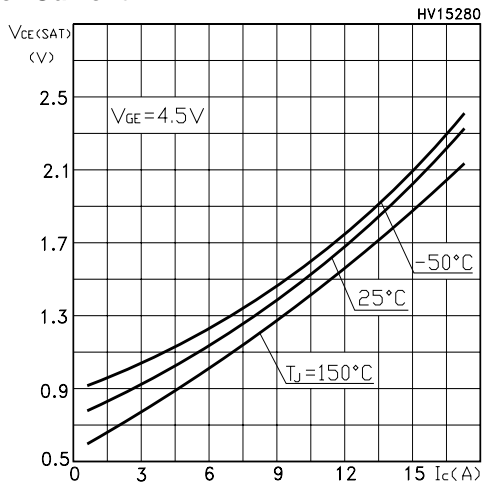

Figure 6: Transfer Characteristics

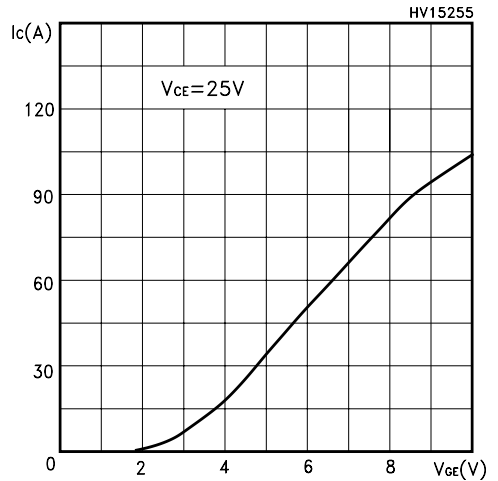

Figure 7: Collector-Emitter On Voltage vs Temperature

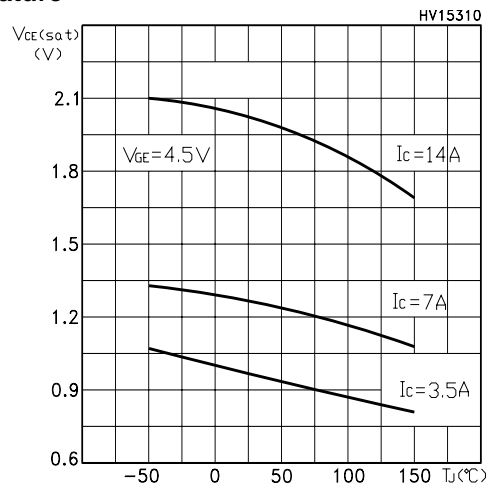

Figure 8: Normalized Collector-Emitter On Voltage vs Temperature

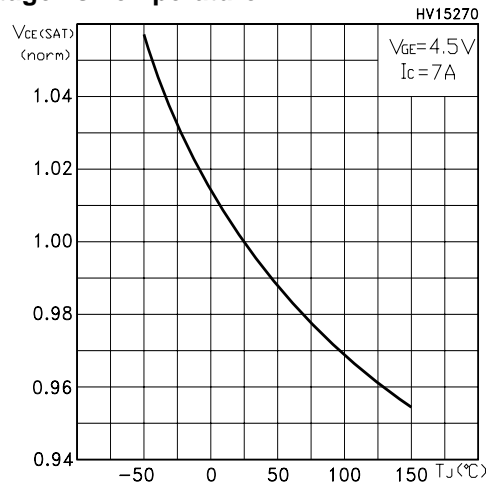

Figure 9: Gate Threshold vs Temperature

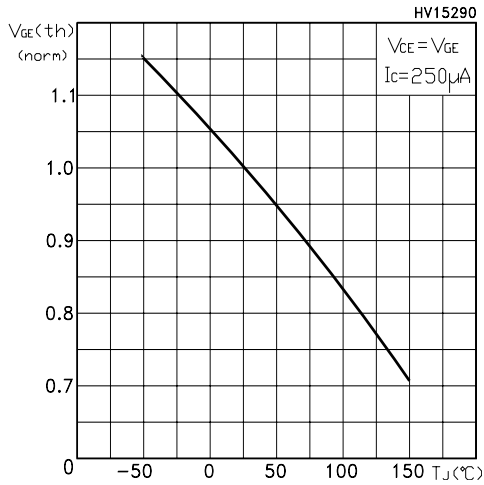

Figure 10: Capacitance Variations

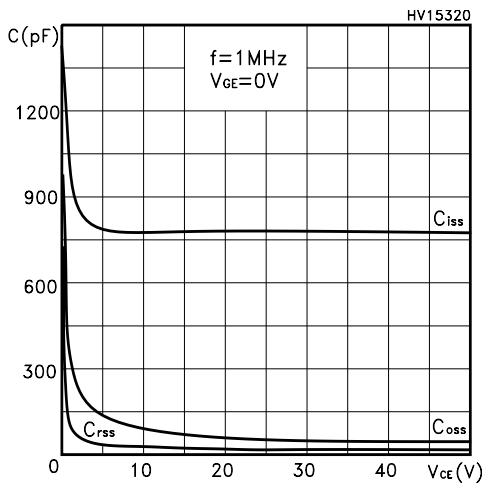

Figure 11: Total Switching Losses vs Gate Resistance

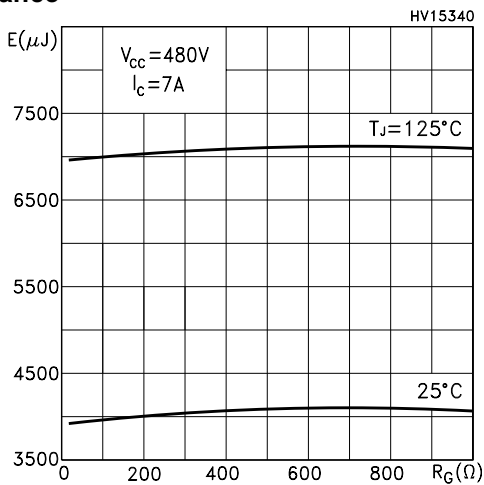

Figure 12: Normalized Breakdown Voltage vs Temperature

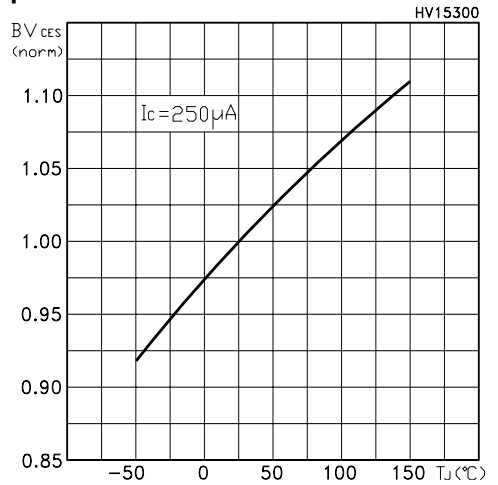

Figure 13: Gate Charge vs Gate-Emitter Voltage

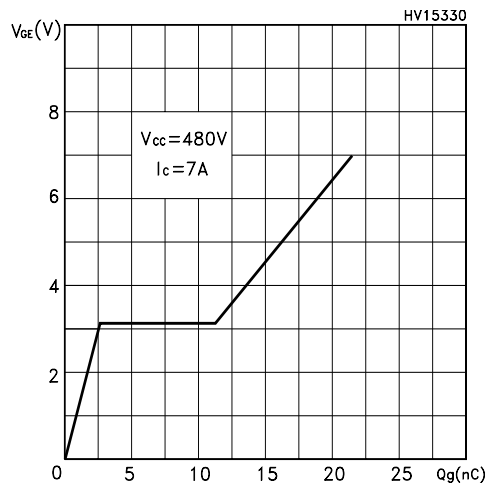

Figure 14: Total Switching Losses vs Temperature

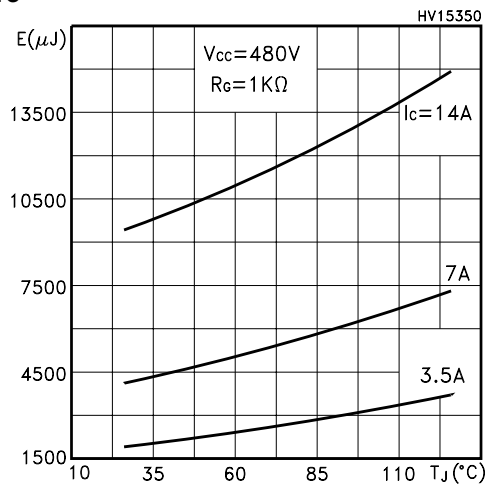

Figure 15: Total Switching Losses vs Collector Current

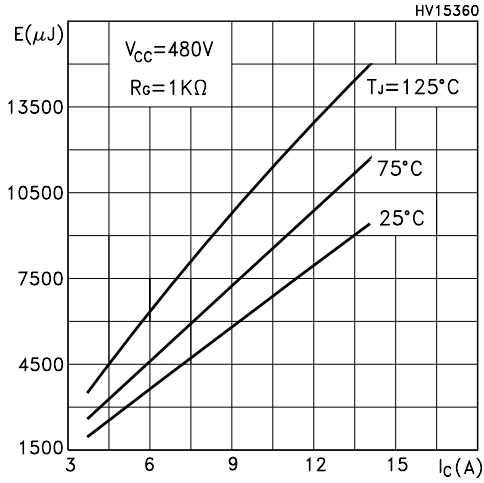

Figure 16: Thermal Impedance

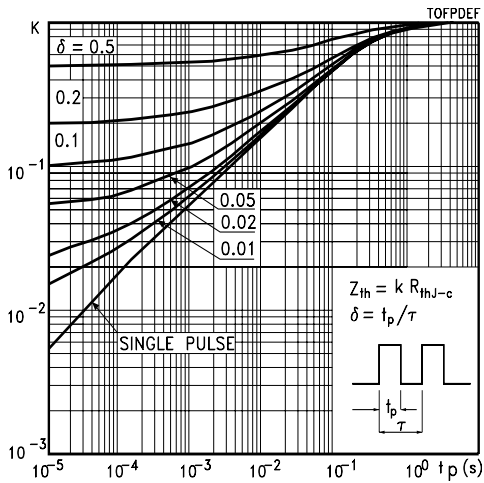

Figure 17: Turn-Off SOA

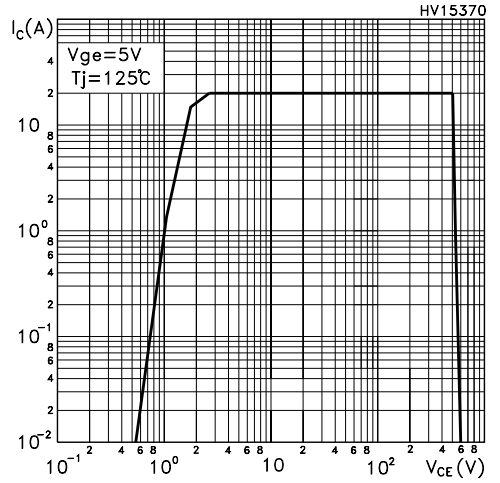

Table 10: Revision History

Date	Revision	Description of Changes
04-June-2004	2	Stylesheet update. No content change

Information furnished is believed to be accurate and reliable. However, STMicroelectronics assumes no responsibility for the consequences of use of such information nor for any infringement of patents or other rights of third parties which may result from its use. No license is granted by implication or otherwise under any patent or patent rights of STMicroelectronics. Specifications mentioned in this publication are subject to change without notice. This publication supersedes and replaces all information previously supplied. STMicroelectronics products are not authorized for use as critical components in life support devices or systems without express written approval of STMicroelectronics.

The ST logo is a registered trademark of STMicroelectronics
All other names are the property of their respective owners

© 2004 STMicroelectronics - All Rights Reserved
STMicroelectronics GROUP OF COMPANIES

Australia - Belgium - Brazil - Canada - China - Czech Republic - Finland - France - Germany - Hong Kong - India - Israel - Italy - Japan - Malaysia - Malta - Morocco - Singapore - Spain - Sweden - Switzerland - United Kingdom - United States.