



Major Ratings and Characteristics

| Characteristics | 30WQ06FN | Units |
|----------------------------------|------------|------------|
| $I_{F(AV)}$ Rectangular waveform | 3.5 | A |
| V_{RRM} | 60 | V |
| I_{FSM} @ $t_p=5 \mu s$ sine | 490 | A |
| V_F @ 3 Apk, $T_J=125^\circ C$ | 0.53 | V |
| T_J | -40 to 150 | $^\circ C$ |

Description/ Features

The 30WQ06FN surface mount Schottky rectifier has been designed for applications requiring low forward drop and small foot prints on PC board. Typical applications are in disk drives, switching power supplies, converters, free-wheeling diodes, battery charging, and reverse battery protection.

- Popular D-PAK outline
- Small foot print, surface mountable
- Low forward voltage drop
- High frequency operation
- Guard ring for enhanced ruggedness and long term reliability

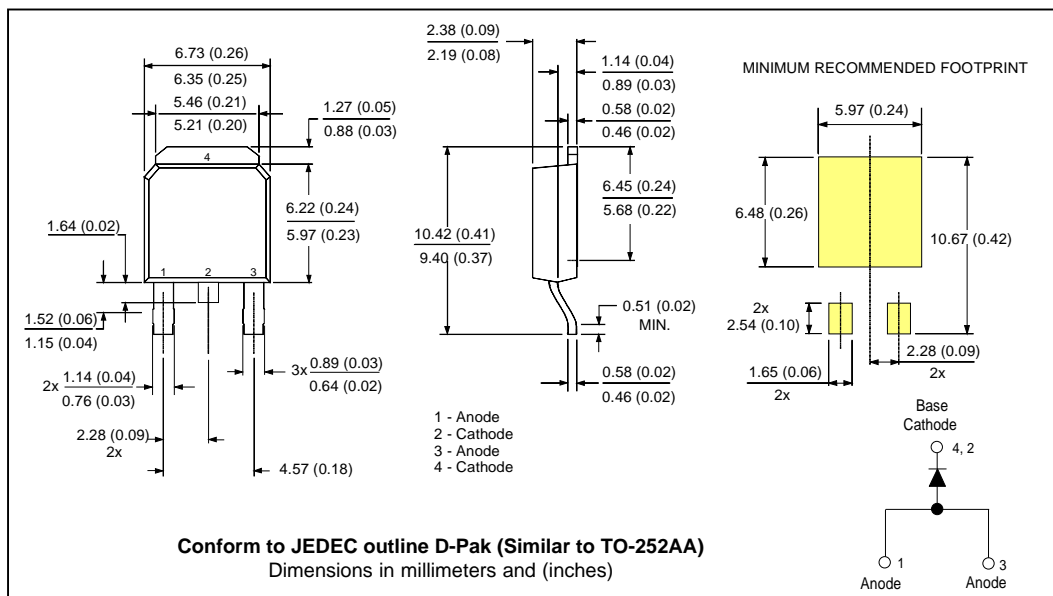

Voltage Ratings

| Part number | 30WQ06FN |
|---|----------|
| V_R Max. DC Reverse Voltage (V) | 60 |
| V_{RWM} Max. Working Peak Reverse Voltage (V) | |

Absolute Maximum Ratings

| Parameters | 30WQ... | Units | Conditions |
|---|---------|-------|--|
| $I_{F(AV)}$ Max. Average Forward Current * See Fig. 5 | 3.5 | A | 50% duty cycle @ $T_C = 133^\circ\text{C}$, rectangular wave form |
| I_{FSM} Max. Peak One Cycle Non-Repetitive Surge Current * See Fig. 7 | 490 | A | Following any rated load condition and with rated V_{RRM} applied |
| | 70 | | |
| E_{AS} Non-Repetitive Avalanche Energy | 6.0 | mJ | $T_J = 25^\circ\text{C}$, $I_{AS} = 1$ Amp, $L = 12$ mH |
| I_{AR} Repetitive Avalanche Current | 1.0 | A | Current decaying linearly to zero in 1 μsec Frequency limited by T_J max. $V_A = 1.5 \times V_R$ typical |

Electrical Specifications

| Parameters | 30WQ... | Units | Conditions |
|---|---------|------------------|---|
| V_{FM} Max. Forward Voltage Drop * See Fig. 1 (1) | 0.61 | V | @ 3A $T_J = 25^\circ\text{C}$ |
| | 0.76 | V | @ 6A |
| | 0.53 | V | @ 3A $T_J = 125^\circ\text{C}$ |
| | 0.65 | V | @ 6A |
| I_{RM} Max. Reverse Leakage Current * See Fig. 2 (1) | 2 | mA | $T_J = 25^\circ\text{C}$ |
| | 30 | mA | $T_J = 125^\circ\text{C}$ $V_R = \text{rated } V_R$ |
| $V_{F(TO)}$ Threshold Voltage | 0.38 | V | $T_J = T_J \text{ max.}$ |
| r_t Forward Slope Resistance | 34.31 | m Ω | |
| C_T Typical Junction Capacitance | 145 | pF | $V_R = 5V_{DC}$, (test signal range 100Khz to 1Mhz) 25°C |
| L_S Typical Series Inductance | 5.0 | nH | Measured lead to lead 5mm from package body |
| dv/dt Max. Voltage Rate of Change | 10000 | V/ μs | (Rated V_R) |

(1) Pulse Width < 300 μs , Duty Cycle < 2%

Thermal-Mechanical Specifications

| Parameters | 30WQ... | Units | Conditions |
|---|------------|---------------------------|---------------------------|
| T_J Max. Junction Temper. Range (*) | -40 to 150 | $^\circ\text{C}$ | |
| T_{stg} Max. Storage Temperature Range | -40 to 150 | $^\circ\text{C}$ | |
| R_{thJC} Max. Thermal Resistance Junction to Case | 4.7 | $^\circ\text{C}/\text{W}$ | DC operation * See Fig. 4 |
| wt Approximate Weight | 0.3(0.01) | g(oz.) | |
| Case Style | D-PAK | | Similar to TO-252AA |

(*) $\frac{dP_{tot}}{dT_J} < \frac{1}{R_{th(j-a)}}$ thermal runaway condition for a diode on its own heatsink

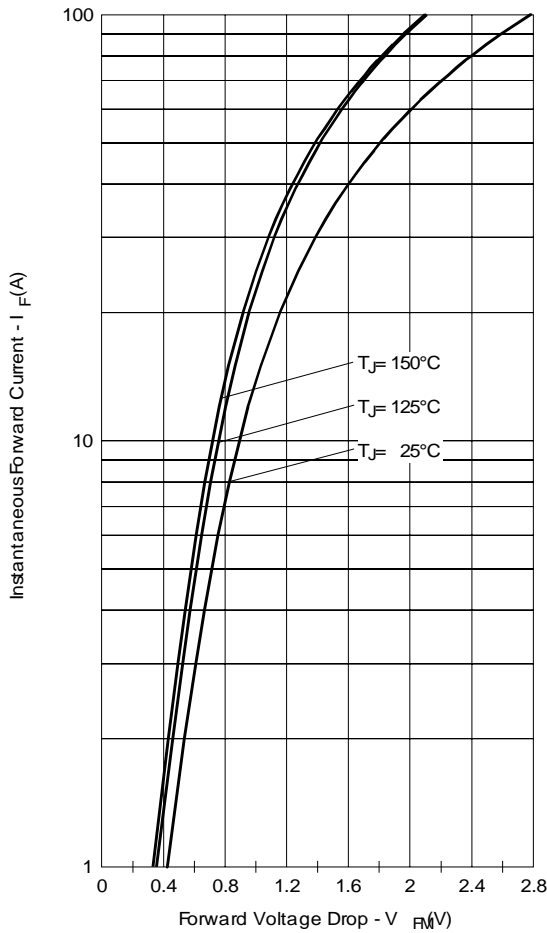

Fig. 1 - Maximum Forward Voltage Drop Characteristics

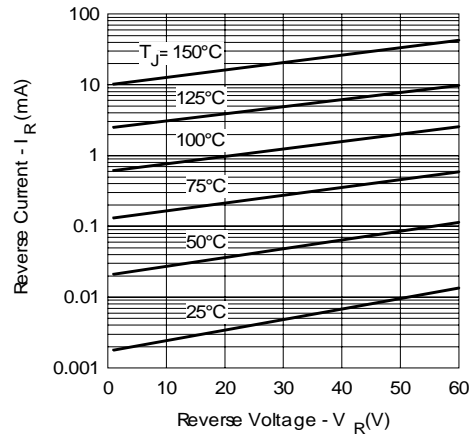

Fig. 2 - Typical Values of Reverse Current Vs. Reverse Voltage

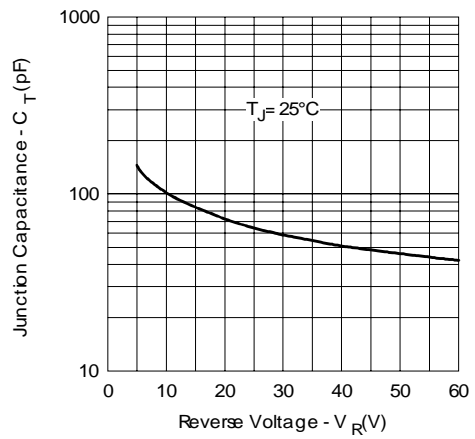

Fig. 3 - Typical Junction Capacitance Vs. Reverse Voltage

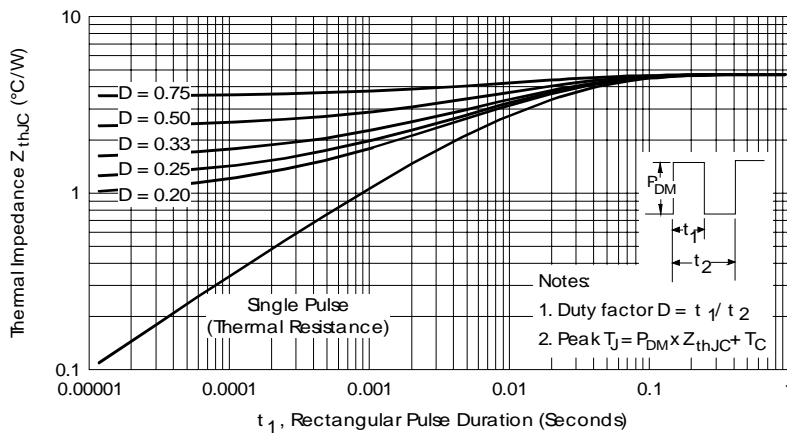

Fig. 4 - Maximum Thermal Impedance Z_{thJC} Characteristics

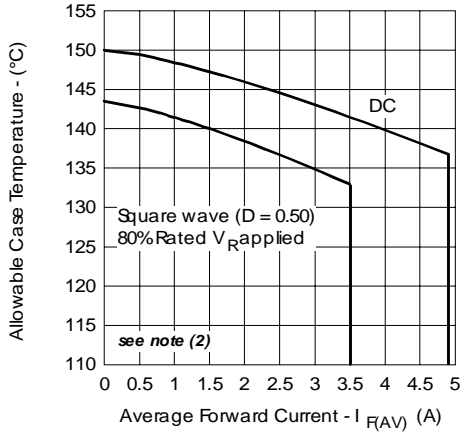

Fig. 5 - Maximum Allowable Case Temperature Vs. Average Forward Current

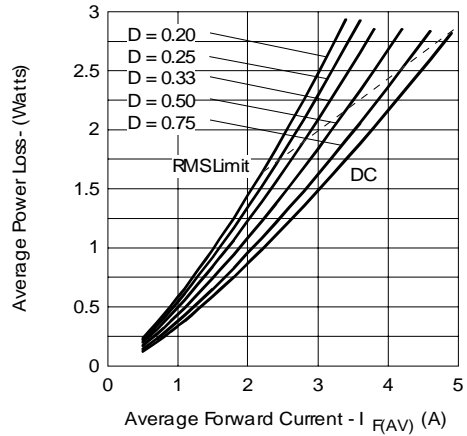

Fig. 6 - Forward Power Loss Characteristics

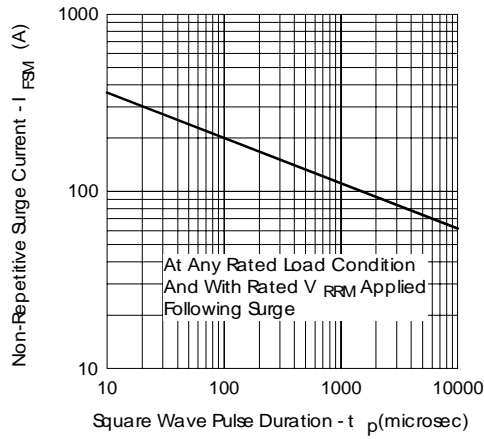
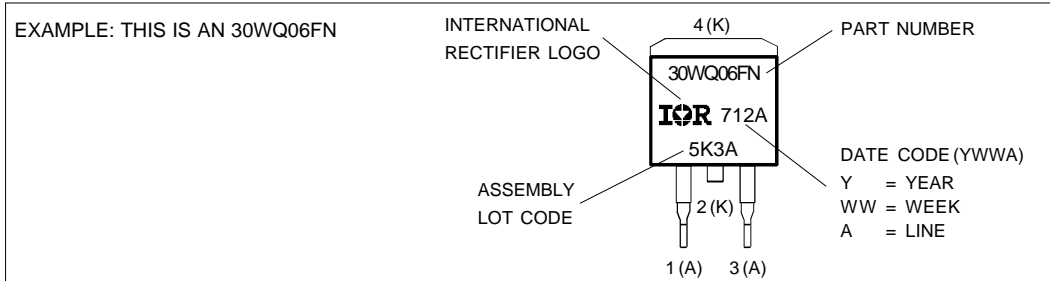

Fig. 7 - Maximum Non-Repetitive Surge Current

- (2) Formula used: $T_c = T_j - (P_d + P_{d_{REV}}) \times R_{thJC}$;
 $P_d = \text{Forward Power Loss} = I_{F(AV)} \times V_{FM} @ (I_{F(AV)} / D)$ (see Fig. 6);
 $P_{d_{REV}} = \text{Inverse Power Loss} = V_{R1} \times I_R (1 - D); I_R @ V_{R1} = 80\% \text{ rated } V_R$

Marking Information



Tape & Reel Information

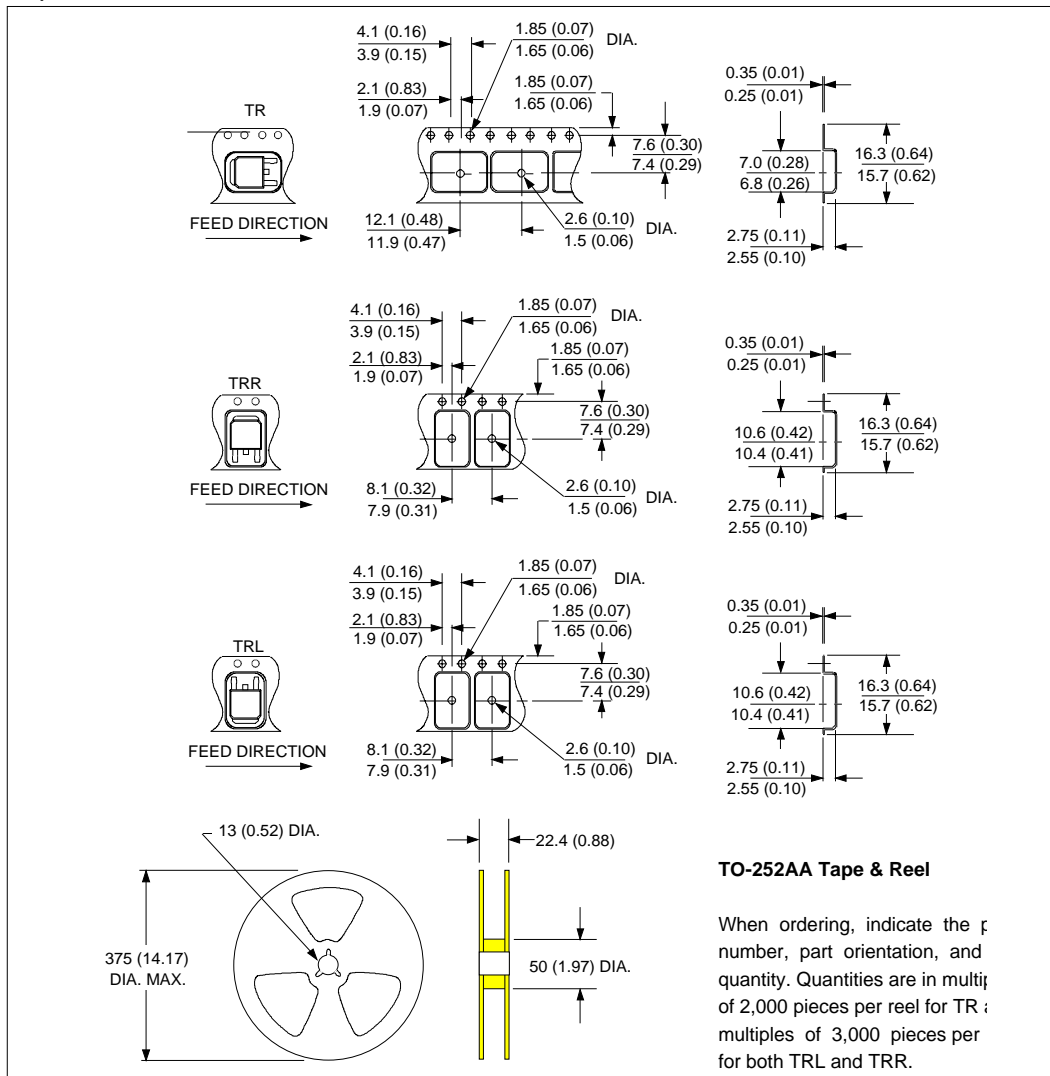

30WQ06FN

Bulletin PD-20522 rev. E 03/03

International
IR Rectifier

Data and specifications subject to change without notice.
This product has been designed and qualified for Industrial Level.
Qualification Standards can be found on IR's Web site.

International
IR Rectifier

IR WORLD HEADQUARTERS: 233 Kansas St., El Segundo, California 90245, USA Tel: (310) 252-7105
TAC Fax: (310) 252-7309
Visit us at www.irf.com for sales contact information. 03/03

This datasheet has been download from:

www.datasheetcatalog.com

Datasheets for electronics components.