

3875081 G E SOLID STATE

Small-Signal MOSFETs

3N128, 3N143

Silicon MOS Transistor

For Amplifier Mixer & Oscillator Applications in Military & Industrial VHF Communications Equipment Operating up to 250 MHz

Features:

- Large dynamic range
- Greatly reduces spurious responses in receiver front ends
- Permits use of vacuum-tube biasing techniques
- Excellent thermal stability
- Superior crossmodulation capability

Applications:

- VHF amplifiers, mixers, converters and if-amplifiers in communication receivers
- High impedance timing circuits
- Detectors, oscillators, frequency multipliers, phase splitters, pulse stretchers and current limiters
- Electrometer amplifiers
- Voltage-controlled attenuators
- High impedance differential amplifiers

RCA-3N128 and 3N143* are N-channel depletion-type silicon field-effect transistors utilizing the MOS construction. The 3N128 is intended primarily for VHF amplifier service in military and industrial applications. It also is extremely well suited for use in dc and low-frequency amplifier applications requiring a transistor having high power gain, very high input impedance, and low gate leakage.

The 3N143 is designed for use as a VHF mixer and oscillator. Because of their improved transfer characteristic and increased dynamic range the 3N128 and 3N143 provide substantially better cross-modulation performance in linear amplifier applications than conventional (bipolar) transistors and are free from

diodecurrent loading common to junction type FET's. These transistors are hermetically sealed in JEDEC TO-72 metal packages and utilize full-gate construction.

Application data for RCA-3N128, including biasing requirements, basic circuit configurations, selection of optimum operating point, and methods for automatic gain control are given in RCA Application Note AN-3193, "Application Considerations for the RCA-3N128 VHF MOS Field-Effect Transistor".

* Formerly Developmental Nos. TA2840 and TA7275, respectively.

Maximum Ratings, Absolute-Maximum Values:

DRAIN-TO-SOURCE VOLTAGE, V_{DS}	+ 20 max. V
GATE-TO-SOURCE VOLTAGE, V_{GS} :	
Continuous dc.....	+ 1, - 8 max. V
Peak ac.....	± 15 max. V
DRAIN CURRENT, I_D (PULSED).....	.50 mA
Peak duration ≤ 20 ms, duty factor ≤ 0.15	
TRANSISTOR DISSIPATION, P_T :	
At ambient } up to 25°C.....	.400 mW
temperatures } above 25°C.....	derate at 2.67 mW/°C
AMBIENT TEMPERATURE RANGE:	
Storage and Operating.....	- 65 to + 175°C
LEAD TEMPERATURE (During Soldering):	
At distances not closer than 1/32 inch to seating surface for 10 seconds maximum.....	265 max. °C

ELECTRICAL CHARACTERISTICS: (At $T_A = 25^\circ\text{C}$)

Measured with Substrate Connected to Source Unless Otherwise Specified.

CHARACTERISTIC	SYMBOL	CONDITIONS	LIMITS						UNITS	
			3N128			3N143				
			MIN	TYP	MAX	MIN	TYP	MAX		
Forward Transconductance	g_{fs}	$V_{DS} = 15\text{ V}, V_{GS} = 0, f = 1\text{ kHz}$ $V_{DS} = 15\text{ V}, I_D = 5\text{ mA}, f = 1\text{ kHz}$	-	10,000	-	-	5,000	7,500	12,000	μmho μmho
Magnitude of Forward Transadmittance	$ y_{fs} $	$V_{DS} = 15\text{ V}, I_D = 5\text{ mA}, f = 200\text{ MHz}$	5,000	7,500	-	-	-	-	-	μmho
Gate Leakage Current	I_{GSS}	$V_{DS} = 0, V_{GS} = -8\text{ V}, T_A = 25^\circ\text{C}$ $V_{DS} = 0, V_{GS} = -8\text{ V}, T_A = 125^\circ\text{C}$	-	0.1	50	-	0.1	1000	100	pA nA
Small-Signal Short-Circuit Input Capacitance	C_{iss}	$V_{DS} = 15\text{ V}, I_D = 5\text{ mA}, f = 0.1\text{ to }1\text{ MHz}$	-	5.5	7	-	5.5	7	-	pF
Small-Signal Short-Circuit Reverse Transfer Capacitance*	C_{rss}	$V_{DS} = 15\text{ V}, I_D = 5\text{ mA}, f = 0.1\text{ to }1\text{ MHz}$	-	0.12	0.20	-	0.12	0.20	-	pF
Small-Signal, Short-Circuit Output Capacitance	C_{oss}	$V_{DS} = 15\text{ V}, I_D = 5\text{ mA}, f = 0.1\text{ to }1\text{ MHz}$	-	1.4	-	-	1.4	-	-	pF
Gate Leakage Resistance	R_{GS}	$V_{DS} = 0, V_{GS} = -8\text{ V}$	-	10^{14}	-	-	10^{14}	-	-	Ω
Drain-to-Source Channel Resistance	$r_{DS(on)}$	$V_{DS} = 0, V_{GS} = 0, f = 1\text{ kHz}$	-	200	-	-	200	-	-	Ω
Gate-to-Source Cutoff Voltage	$V_{GS(off)}$	$V_{DS} = 15\text{ V}, I_D = 50\text{ }\mu\text{A}$	-2	-3.5	-8	-2	-3.5	-8	-	V
Drain-to-Source Cutoff Current	$I_D(off)$	$V_{DS} = 20\text{ V}, V_{GS} = -8\text{ V}$	-	-	50	-	-	50	-	μA
Zero-Bias Drain Current**	I_{DSS}	$V_{DS} = 15\text{ V}, V_{GS} = 0$	5	15	25	10	20	50	-	mA
Input Conductance	g_{is}	$V_{DS} = 15\text{ V}, I_D = 5\text{ mA}, f = 1\text{ kHz}$	-	-	-	-	-	10	-	μmho
Output Conductance	g_{os}	$V_{DS} = 15\text{ V}, I_D = 5\text{ mA}, f = 1\text{ kHz}$	-	-	-	-	-	1,000	-	μmho
Power Gain Maximum Available Gain Maximum Usable Gain (Neutralized) see Fig.1	G_{PS}	$V_{DS} = 15\text{ V}, I_D = 5\text{ mA}, f = 200\text{ MHz}$	15 13.5	20 16	-	-	-	-	-	dB dB
Power Gain (Conversion (See Fig.3))	$G_{PS(c)}$	$V_{DS} = 15\text{ V}, I_D = 1\text{ mA}, f_{in} = 200\text{ MHz}$ $f_{out} = 30\text{ MHz}$	-	-	-	10	13.5	-	-	dB
Noise Figure (see Figs. 1 & 2)	NF	$V_{DS} = 15\text{ V}, I_D = 5\text{ mA}, f = 200\text{ MHz}$	-	3.5	5	-	-	-	-	

* Three-Terminal Measurement: Source Returned to Guard Terminal.

** Pulse Test: Pulse Duration 20 ms max. Duty Factor ≤ 0.15 .

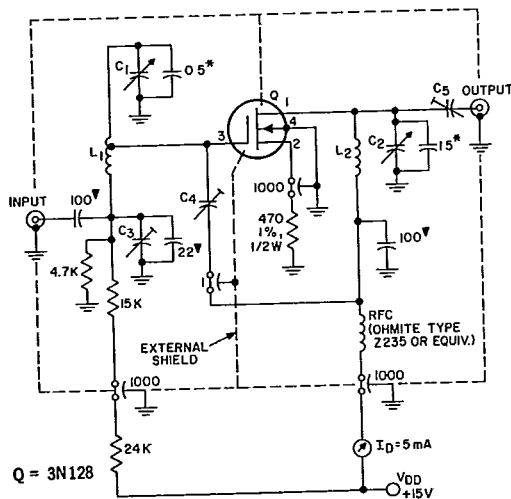

All Resistors in ohms and 1/4 W unless otherwise specified. All Capacitors in pF

* TUBULAR CERAMIC
▼ DISC CERAMIC

92CS-14892

Fig. 1 - Test Circuit used to Measure 200 MHz Maximum Usable Power Gain and Noise Figure

C_1, C_2 : 1.5-5 pF variable air capacitor: E. F. Johnson Type 160-102 or equivalent

C_3 : 1-10 pF piston-type variable air capacitor: JFD Type VAM-010, Johanson Type 4335, or equivalent

C_4, C_5 : 0.3-3 pF piston-type variable air capacitor: Roanwell Type MH-13 or equivalent

L_1 : 5 turns silver-plated 0.02" thick, 0.07"-0.08" wide copper ribbon. Internal diameter of winding = 0.25"; winding length approx. 0.65". Tapped at 1-1/2 turns from C_1 end of winding

L_2 : Same as L_1 except winding length approx. 0.7"; no tap.

3N128, 3N143

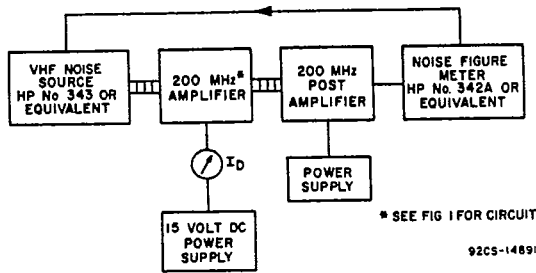
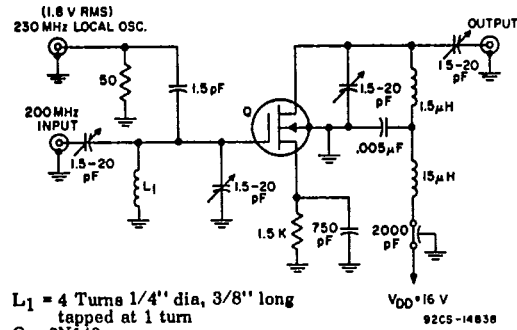

Fig.2 - Noise Figure Measurement Setup for 3N128



$L_1 = 4$ Turns $1/4''$ dia, $3/8''$ long
 tapped at 1 turn
 $Q = 3N143$

Fig.3 - Conversion Power Gain Test Circuit.

TYPICAL CHARACTERISTICS

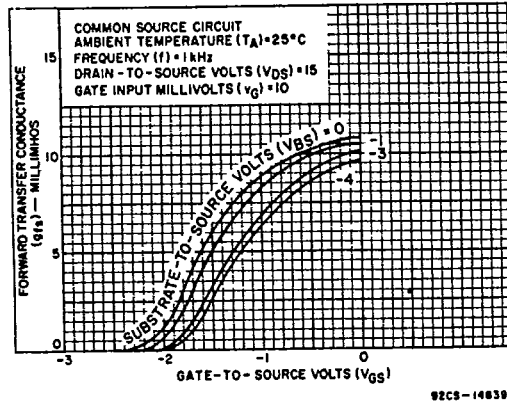

Fig.4 - Forward Transconductance vs Gate-Bias Voltage.

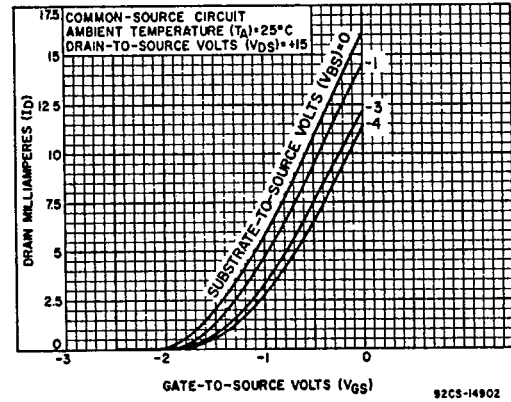

Fig.5 - Drain Current vs Gate-to-Source Voltage.

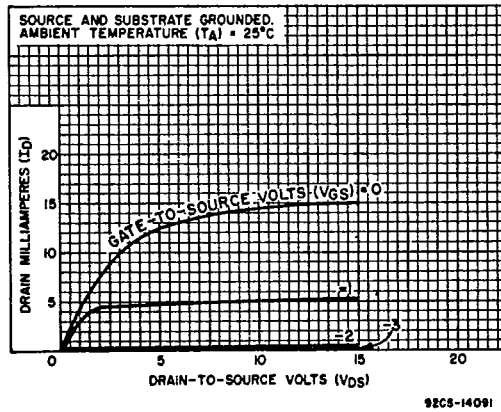

Fig.6 - Drain Current vs Drain-to-Source Voltage.

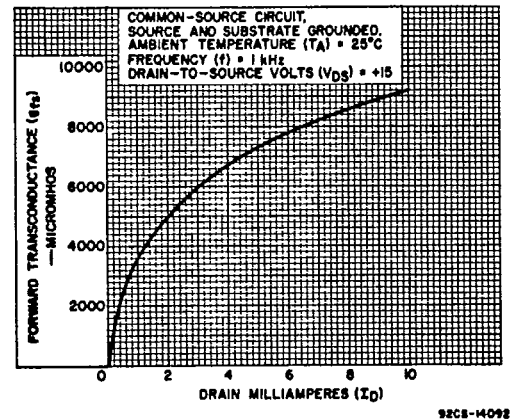

Fig.7 - 1-kHz Forward Transconductance vs Drain Current.

TYPICAL 200-MHz COMMON-SOURCE ADMITTANCE (Y)
COMPONENTS vs DRAIN CURRENT

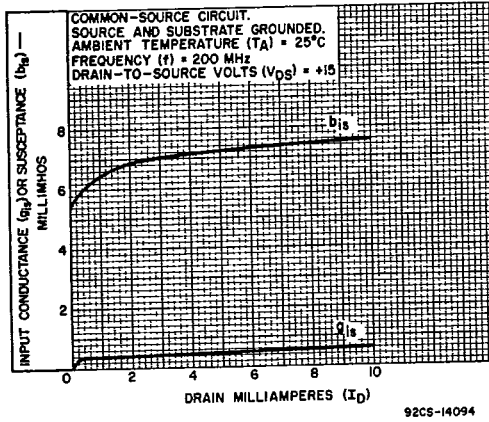

Fig.8 - Input Admittance (Y_{is}) Components.

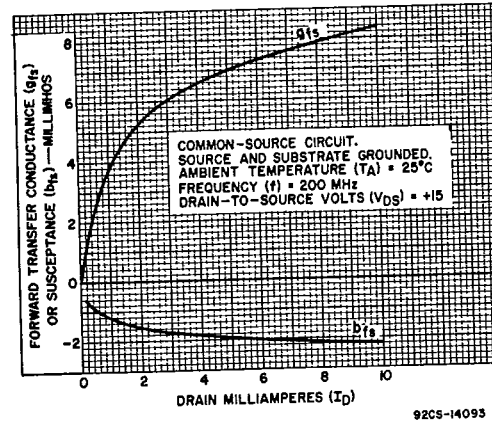

Fig.9 - Forward Transadmittance (Y_{fs}) Components.

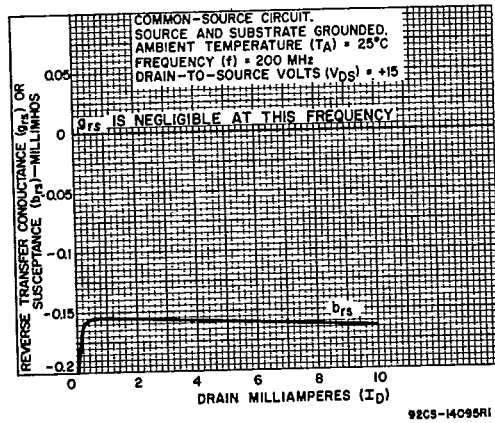

Fig.10 - Reverse Transadmittance (Y_{rs}) Components.

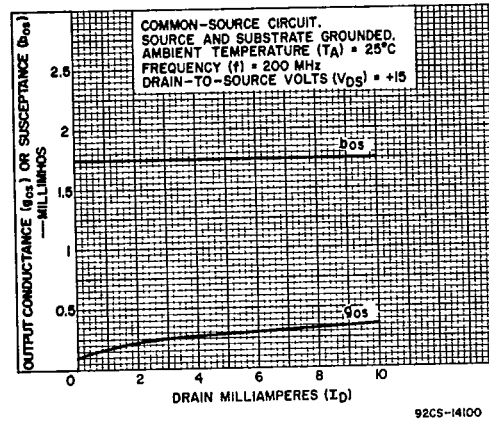

Fig.11 - Output Admittance (Y_{os}) Components.

Small-Signal MOSFETs

3N128, 3N143

3875081 G E SOLID STATE

01E 14988

D T-31-25

TERMINAL DIAGRAM

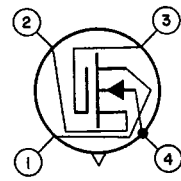

- 1 - Drain
- 2 - Source
- 3 - Insulated Gate
- 4 - Bulk (Substrate) and Case

OPERATING CONSIDERATIONS

The flexible leads of the 3N128 and 3N143 are usually soldered to the circuit elements. As in the case of any high-frequency semiconductor device, the tips of soldering irons should be grounded, and appropriate precautions should be taken to protect the devices against high electric fields.

These devices should not be connected into or disconnected from circuits with the power on because high transient voltages may cause permanent damage to the devices.

This datasheet has been downloaded from:

www.DatasheetCatalog.com

Datasheets for electronic components.