

IC for Headphone Stereos

Monolithic IC LAG673

Outline

This IC was developed for use in 3 V headphone stereos. It incorporates dual preamp, power amp, electronic volume and motor control circuits; because it requires extremely few external components, it can be used in a simple circuit configuration.

Features

1. Broad operating voltage range of 2.0 to 5.0 V
2. Few external components required
3. Well-balanced electronic VR, A-curve attenuation characteristic obtained with B-curve VR
4. Internal motor control circuit, with noise from motor driving unit suppressed
5. Fast forward possible using the forced-on pin

Package

SOP-28B (LAG673F)

SDIP-30A (LAG673D)

Absolute Maximum Ratings

Item	Symbol	Ratings	Units
Operating temperature	T _{OPR}	-20~+65	°C
Storage temperature	T _{STG}	-40~+125	°C
Power supply current	V _{CC}	-0.3~+7.5	V
Operating voltage	V _{OP}	2.0~5.0	V
Power consumption	P _d	450 (SOP-28B) 750 (SDIP-30A)	mW

Electrical Characteristics (Except where noted otherwise, Ta=25°C)

Item	Symbol	Measurement conditions	Min.	Typ.	Max.	Units
Consumption current (excluding motor speed controller unit)	I _{cc}	V _{IN} =0V, I _M =0mA		18	25	mA
Preamp unit (Ta=25°C)						
Open-circuit gain	G _{vo}	V _o =-10dBm, R _L =∞		72		dB
Closed-circuit gain	G _{vc}	V _o =-10dBm	40	42	44	dB
Maximum output voltage	V _{om}	THD=10%	0.30	0.45		V _{rms}
Total harmonic distortion ratio	THD	V _{OUT} =400mV _{rms}		0.05	0.5	%
Output noise voltage	V _{no}	V _{IN} =0V, R _g =2.2kΩ, BPF=30Hz~20kHz		150	300	μV _{rms}
Input impedance	Z _{in}	V _{OUT} =-10dBm	18	22		kΩ
Crosstalk between channels	C · T	R _g =2.2kΩ, V _{OUT} =-10dBm	30			dB
Output voltage with preamp off	V _{ooff}	V _{IN} =100mV _{rms}			-50	dB
Output resistance with preamp off	R _{ooff}			10		kΩ
Input resistance with preamp off	R _{ioff}			10		kΩ
Attenuator unit (Ta=25°C)						
Maximum input voltage	V _{i max.}		0.2			V _{rms}
Maximum attenuation	V _{a max.}	V _{cont} =min.	66			dB
Attenuation error	V _{aerr}	V _{cont} =max.		0		dB
Input impedance	Z _{ia}		15	20		kΩ
Control pin input resistance	Z _{icot}			100		kΩ
Power amp unit (Ta=25°C)						
Voltage gain	G _v	P _{OUT} =5mW	26	28	30	dB
Voltage gain difference between channels	ΔG _v	V _{cont} =max.		0	3	dB
Maximum output power I	P _{om}	THD=10%, R _L =32Ω	20	28		mW
Maximum output power II	P _{om}	THD=10%, R _L =16Ω	30			mW
Total harmonic distortion ratio	THD	P _{OUT} =5mW		0.2	2.0	%
Crosstalk between channels	C · T	P _{OUT} =5mW	45	55		dB
Output noise voltage	V _n	R _g =2.2kΩ, V _{cont} =min.		0.25	1.0	mV _{rms}
Ripple rejection	RR	100Hz, 100mV _{p-p}	42	50		dB
Noise of preamp + power amp	V _{nto}	V _{IN} =0V, R _g =2.2kΩ, V _{cont} =max.		6	9	mV _{rms}
Motor control unit (Ta=25°C)						
Consumption current	I _{MC}			3.0	5.0	mA
Startup current	I _{MS}		500			mA
Reference voltage	V _{ref}	Between RML-ADJ pins	0.72	0.80	0.87	V
Reference voltage fluctuation I	ΔV _{ref1}	V _{CC} between 2.0 and 5.0V *		0.05		%/V
Reference voltage fluctuation II	ΔV _{ref2}	I _M between 25 and 250 mA		0.01		%/mA
Reference voltage fluctuation III	ΔV _{ref3}	Ta between -10 and 50°C		0.01		%/°C
Current coefficient	ΔK	$K = \frac{\Delta V_{RL}}{R_L \Delta I_M}$	32	38	43	
Current coefficient fluctuation I	ΔK1	V _{CC} between 2.0 and 6.5 V		0.5		%/V
Current coefficient fluctuation II	ΔK2	I _M between 25 and 250 mA		0.05		%/mA
Current coefficient fluctuation III	ΔK3	Ta between -10 and 60°C		0.02		%/°C
Output voltage on forced on	V _{CEsa}	T _M =200mA			0.6	V
Input resistance on forced on	R _{ion}			5.6		kΩ
Leakage current on forced off	I _{ML}				200	μA
Input resistance on forced off	R _{icon}			33		kΩ

Conditions: V_{CC}=3.0 V, I_M = 100 mA Motor: M25E-7 (Mitsumi model)

*Voltage drift between pins 17 and 13

Block Diagram

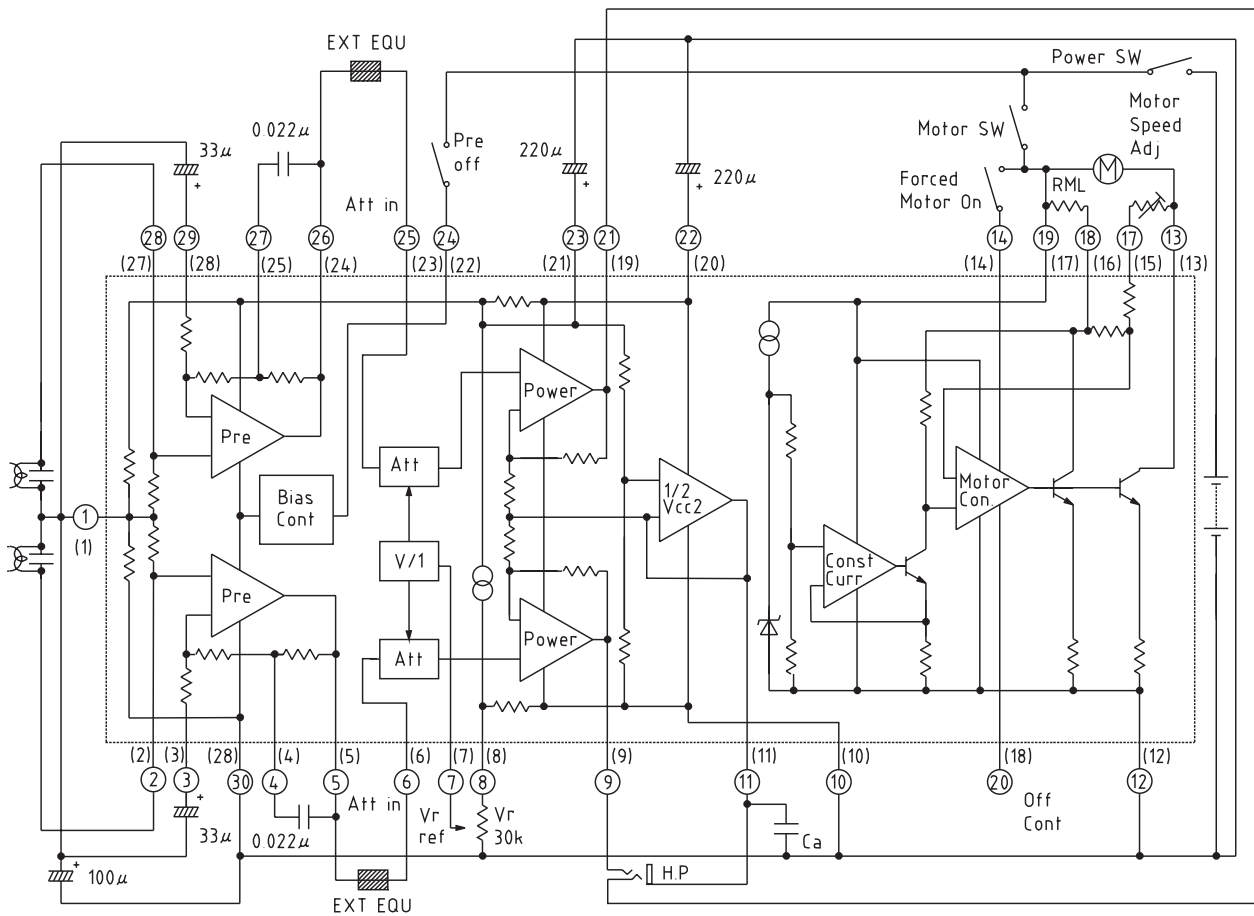

- 1: The motor speed potentiometer is 1.5 kΩ (assuming the motor used is Mitsumi M25E-7; if the optimal adjustment range is not obtained using a different motor, add a fixed resistance).
- 2: RML = motor load correction resistance
- 3: Connecting the preamp off pin to +V_{CC} turns the preamp circuits off.
- 4: Connecting the motor forced-on pin to +V_{CC} turns the motor on (no control).
- 5: in circles are pin numbers for a DIP-30P package; numbers in parentheses () are for an SOP-28B package.
- 6: In the DIP-30P package, pins 15 and 16 are NC.
- 7: C_a is a 100,000 pF capacitor used to prevent oscillation of the 1/2 V_{CC} amp circuit.

Characteristics

Preamp

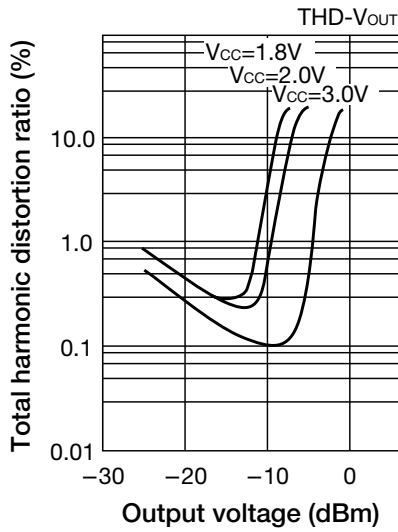

Attenuator

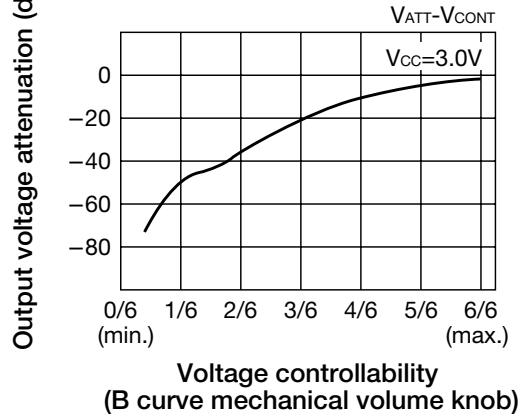

P_{OUT.}

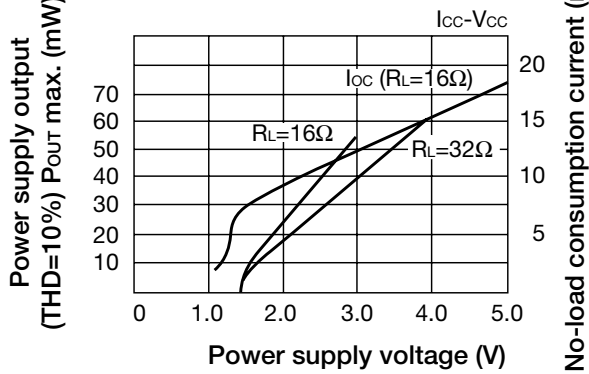

Power amp

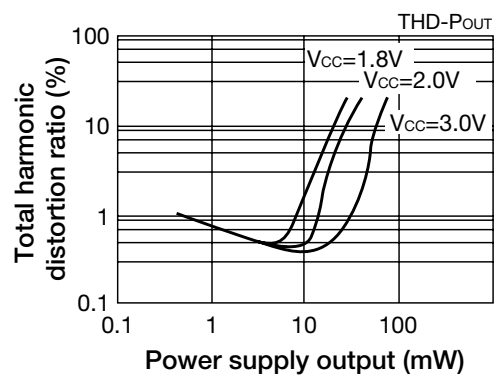

Power amp

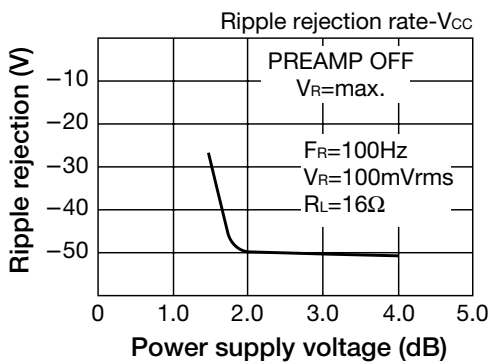

Power amp

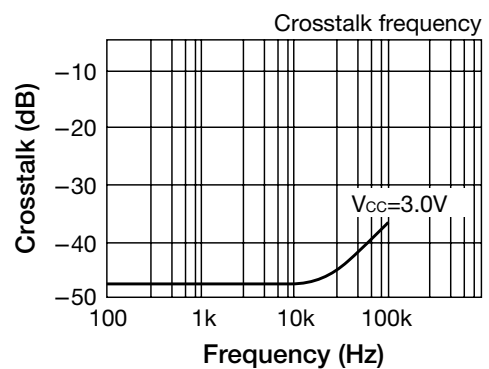

Voltage gain vs. Frequency

