



ATTENTION
OBSERVE PRECAUTIONS
FOR HANDLING
ELECTROSTATIC
DISCHARGE
SENSITIVE
DEVICES

AAF5060PBESURVG

BLUE
HYPER RED
GREEN

Features

- OUTSTANDING MATERIAL EFFICIENCY.
- RELIABLE AND RUGGED.
- WATER CLEAR LENS.
- LOW POWER CONSUMPTION.
- ONE BLUE, ONE RED AND ONE GREEN CHIPS IN ONE PACKAGE.
- CAN PRODUCE ANY COLOR IN VISIBLE SPECTRUM, INCLUDING WHITE LIGHT.
- RoHS COMPLIANT.

Description

The Blue source color devices are made with InGaN on SiC Light Emitting Diode.

The Hyper Red source color devices are made with DH InGaAlP on GaAs substrate Light Emitting Diode.

The Green source color devices are made with InGaN on SiC Light Emitting Diode.

Static electricity and surge damage the LEDs.

It is recommended to use a wrist band or anti-electrostatic glove when handling the LEDs.

All devices, equipment and machinery must be electrically grounded.

Package Dimensions

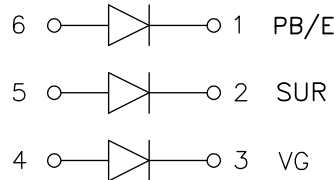
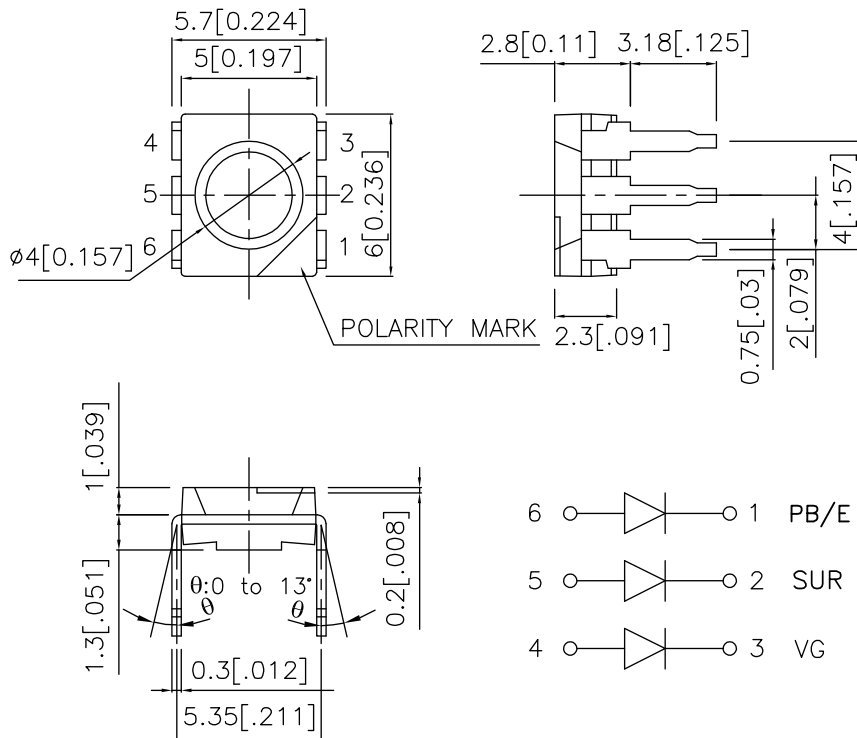

Notes:

1. All dimensions are in millimeters (inches).
2. Tolerance is ± 0.25 (0.01") unless otherwise noted.
3. Lead spacing is measured where the leads emerge from the package.
4. Specifications are subject to change without notice.

Selection Guide

Part No.	Dice	Lens Type	Iv (mcd) @ 30mA *50mA		Viewing Angle
			Min.	Typ.	2θ1/2
AAF5060PBESURVG	BLUE (InGaN)	WATER CLEAR	110	250	100°
	HYPER ORANGE(InGaAlP)		*380	*500	
	GREEN (InGaN)		180	350	

Notes:

1. θ1/2 is the angle from optical centerline where the luminous intensity is 1/2 the optical centerline value.
2. * Luminous intensity with asterisk is measured at 50mA.

Electrical / Optical Characteristics at TA=25°C

Symbol	Parameter	Device	Typ.	Max.	Units	Test Conditions
λ _{peak}	Peak Wavelength	Blue Hyper Red Green	465 640 520		nm	I _F =20mA
λ _D	Dominant Wavelength	Blue Hyper Red Green	470 628 525		nm	I _F =20mA
Δλ _{1/2}	Spectral Line Half-width	Blue Hyper Red Green	25 27 38		nm	I _F =20mA
C	Capacitance	Blue Hyper Red Green	110 45 45		pF	V _F =0V;f=1MHz
V _F	Forward Voltage	Blue Hyper Red Green	3.7 1.9 3.5	4.3 2.5 4.5	V	I _F =20mA
I _R	Reverse Current	All		10	uA	V _R = 5V

Absolute Maximum Ratings at TA=25°C

Parameter	Blue	Hyper Red	Green	Units
Power dissipation [2]	350			mW
DC Forward Current	30	50	30	mA
Peak Forward Current [1]	160	185	150	mA
Reverse Voltage	5	5	5	V
Operating / Storage Temperature	-40°C To +85°C			
Lead Solder Temperature [3]	260°C For 3 Seconds			
Lead Solder Temperature [4]	260°C For 5 Seconds			

Notes:

1. Within 350mW at all chips are lightened.
2. 1/10 Duty Cycle, 0.1ms Pulse Width.
3. 2mm below package base.
4. 5mm below package base.

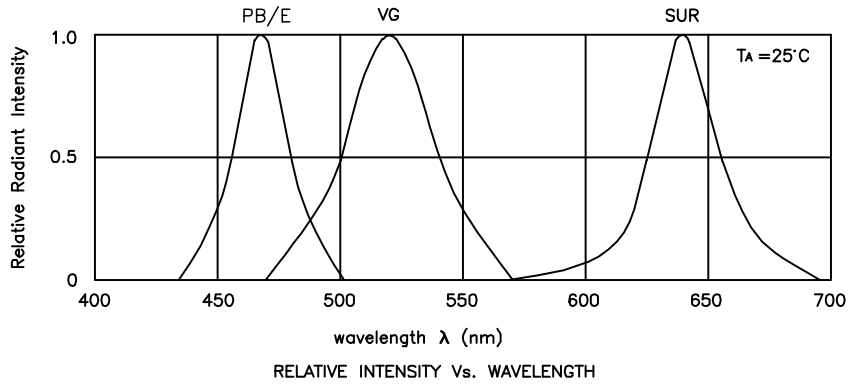

AAF5060PBESURVG Blue

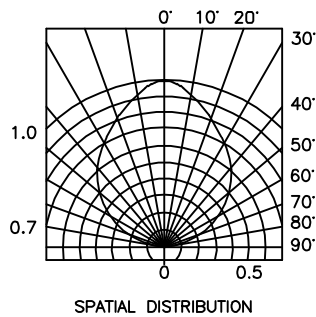
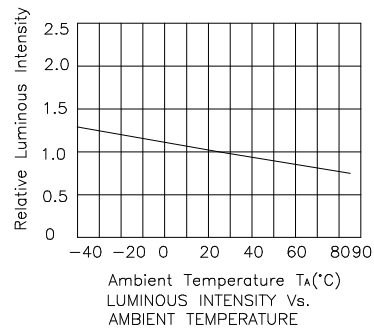
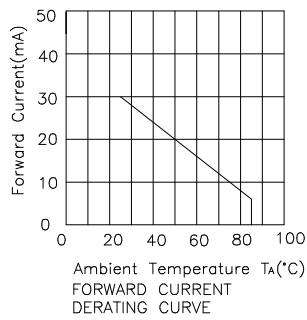
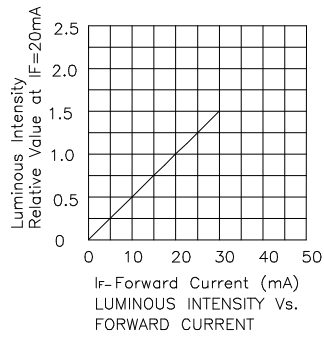
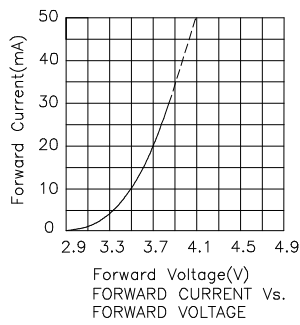

Kingbright

Hyper Red

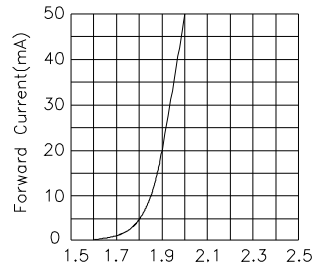

Forward Voltage(V)
FORWARD CURRENT Vs.
FORWARD VOLTAGE

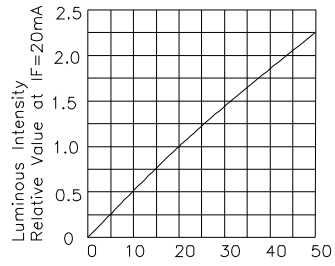

I_f -Forward Current (mA)
LUMINOUS INTENSITY Vs.
FORWARD CURRENT

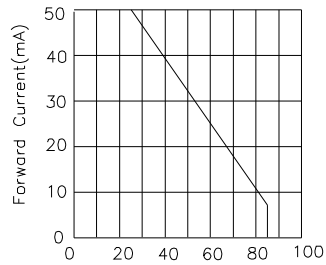

Ambient Temperature T_A (°C)
FORWARD CURRENT
DERATING CURVE

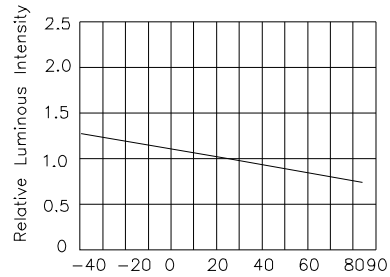

Ambient Temperature T_A (°C)
LUMINOUS INTENSITY Vs.
AMBIENT TEMPERATURE

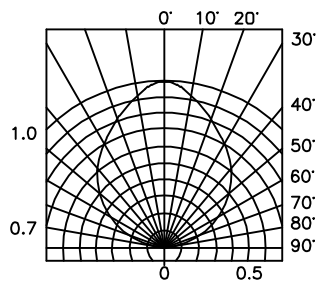

SPATIAL DISTRIBUTION

Green

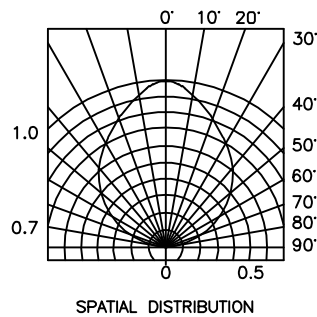
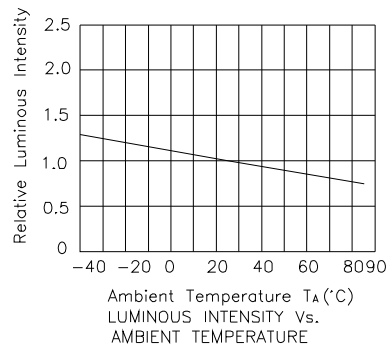
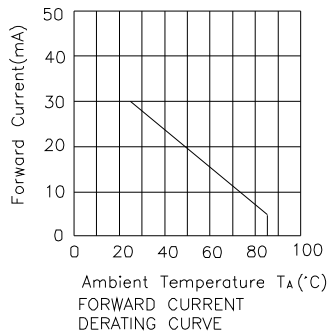
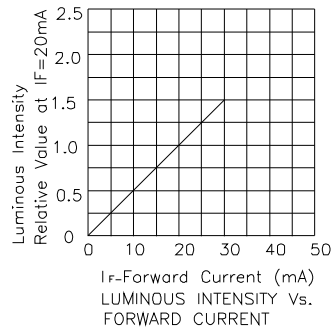
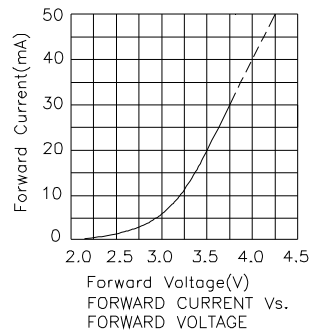

If special sorting is required (e.g. binning based on forward voltage, luminous intensity, or wavelength), the typical accuracy of the sorting process is as follows:

1. Wavelength: +/-1nm
2. Luminous Intensity: +/-15%
3. Forward Voltage: +/-0.1V

Note: Accuracy may depend on the sorting parameters.