



P-Channel 80-V (D-S) MOSFET

CHARACTERISTICS

- P-Channel Vertical DMOS
- Macro Model (Subcircuit Model)
- Level 3 MOS
- Apply for both Linear and Switching Application
- Accurate over the -55 to 125°C Temperature Range
- Model the Gate Charge, Transient, and Diode Reverse Recovery Characteristics

DESCRIPTION

The attached spice model describes the typical electrical characteristics of the p-channel vertical DMOS. The subcircuit model is extracted and optimized over the -55 to 125°C temperature ranges under the pulsed 0-V to 10-V gate drive. The saturated output impedance is best fit at the gate bias near the threshold voltage.

A novel gate-to-drain feedback capacitance network is used to model the gate charge characteristics while avoiding convergence difficulties of the switched C_{gd} model. All model parameter values are optimized to provide a best fit to the measured electrical data and are not intended as an exact physical interpretation of the device.

SUBCIRCUIT MODEL SCHEMATIC

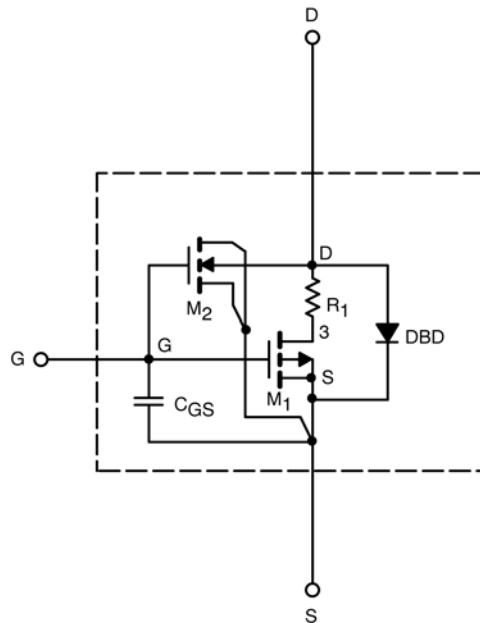

This document is intended as a SPICE modeling guideline and does not constitute a commercial product data sheet. Designers should refer to the appropriate data sheet of the same number for guaranteed specification limits.



SPECIFICATIONS ($T_J = 25^\circ\text{C}$ UNLESS OTHERWISE NOTED)					
Parameter	Symbol	Test Condition	Simulated Data	Measured Data	Unit
Static					
Gate Threshold Voltage	$V_{GS(th)}$	$V_{DS} = V_{GS}, I_D = -250 \mu\text{A}$	3.1		V
On-State Drain Current ^a	$I_{D(on)}$	$V_{DS} = -5 \text{ V}, V_{GS} = -10 \text{ V}$	25		A
Drain-Source On-State Resistance ^a	$r_{DS(on)}$	$V_{GS} = -10 \text{ V}, I_D = -1.2 \text{ A}$	0.192	0.216	Ω
		$V_{GS} = -6 \text{ V}, I_D = -1.1 \text{ A}$	0.215	0.242	
Forward Transconductance ^a	g_{fs}	$V_{DS} = -15 \text{ V}, I_D = -1.2 \text{ A}$	4	4.3	S
Diode Forward Voltage ^a	V_{SD}	$I_S = -0.63 \text{ A}$	-0.74	-0.80	V
Dynamic^b					
Input Capacitance	C_{iss}	$V_{DS} = -40 \text{ V}, V_{GS} = 0 \text{ V}, f = 1 \text{ MHz}$	636	500	pF
Output Capacitance	C_{oss}		39	40	
Reverse Transfer Capacitance	C_{rss}		25	25	
Total Gate Charge	Q_g	$V_{DS} = -40 \text{ V}, V_{GS} = -10 \text{ V}, I_D = -1.2 \text{ A}$	10	11	nC
Gate-Source Charge	Q_{gs}	$V_{DS} = -40 \text{ V}, V_{GS} = -6 \text{ V}, I_D = -1.2 \text{ A}$	6	7	
Gate-Source Charge	Q_{gs}		2.1	2.1	
Gate-Drain Charge	Q_{gd}		3.2	3.2	

Notes

- a. Pulse test; pulse width $\leq 300 \mu\text{s}$, duty cycle $\leq 2\%$.
- b. Guaranteed by design, not subject to production testing.



SPICE Device Model Si2337DS

Vishay Siliconix

COMPARISON OF MODEL WITH MEASURED DATA ($T_J=25^\circ\text{C}$ UNLESS OTHERWISE NOTED)

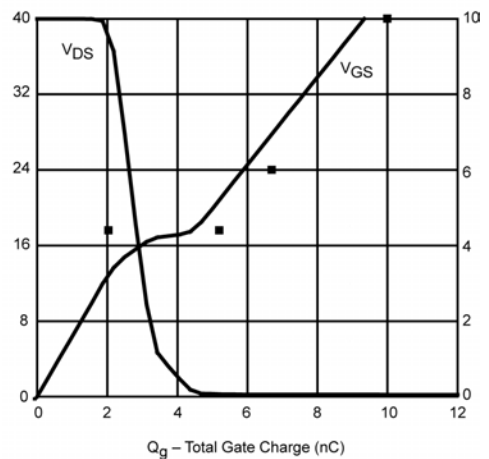
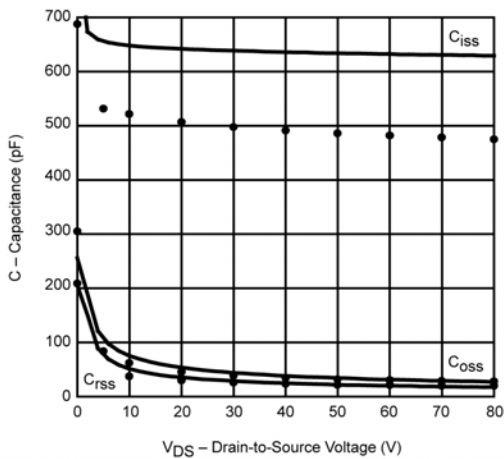
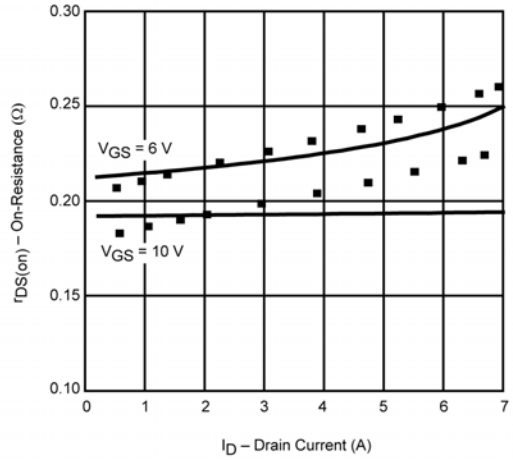
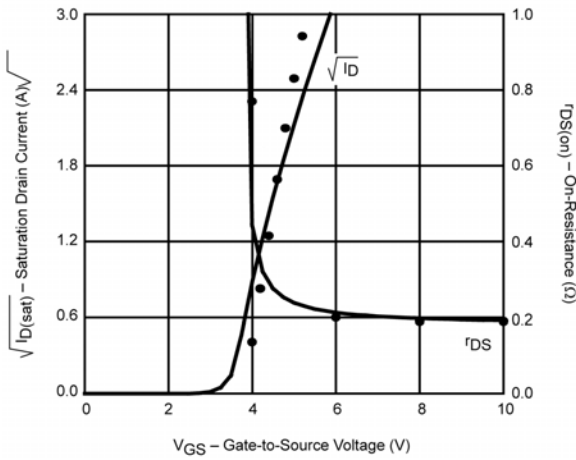
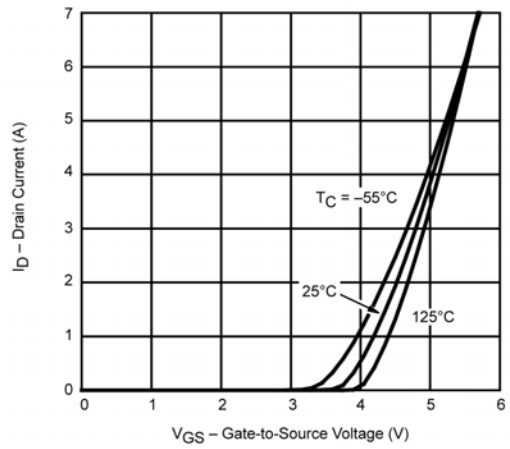
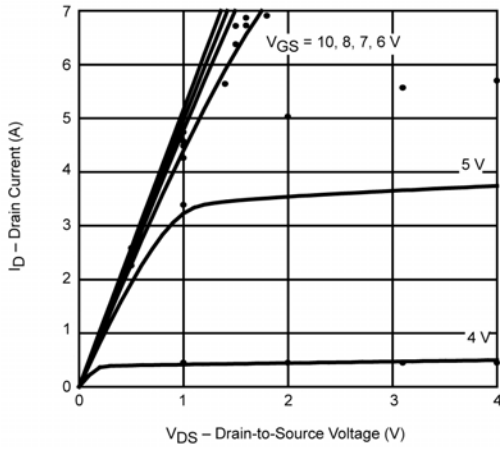

Note: Dots and squares represent measured data.