

Integrated Silicon Pressure Sensor On-Chip Signal Conditioned, Temperature Compensated and Calibrated

The MPXV4115V series piezoresistive transducer is a state-of-the-art monolithic silicon pressure sensor designed for a wide range of applications, particularly those employing a microcontroller with A/D inputs. This transducer combines advanced micromachining techniques, thin-film metallization and bipolar processing to provide an accurate, high-level analog output signal that is proportional to the applied pressure/vacuum. The small form factor and high reliability of on-chip integration make the Motorola sensor a logical and economical choice for the automotive system designer. Figure 1 shows a block diagram of the internal circuitry integrated on a pressure sensor chip.

Features

- 1.5 % Maximum error over 0° to 85°C
- Temperature Compensated from -40° + 125°C
- Ideally Suited for Microprocessor or Microcontroller-Based Systems
- Durable Thermoplastic (PPS) Surface Mount Package

Application Examples

- Vacuum Pump Monitoring
- Brake Booster Monitoring

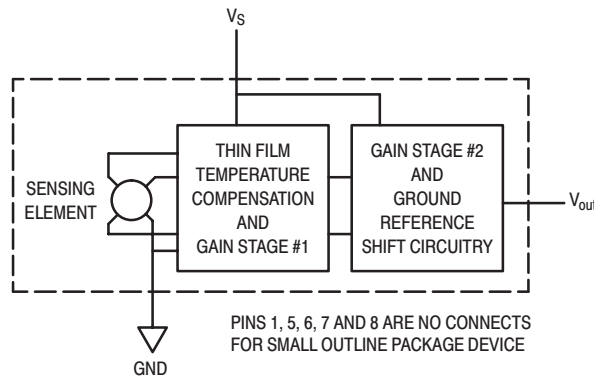
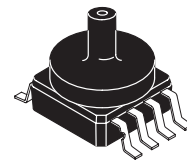

Figure 1. Fully Integrated Pressure Sensor Schematic

MPXV4115V SERIES

**INTEGRATED
PRESSURE SENSOR**
-115 to 0 kPa (-16.7 to 2.2 psi)
0.2 to 4.6 V OUTPUT

SMALL OUTLINE PACKAGE



MPXV4115VC6U
CASE 482A

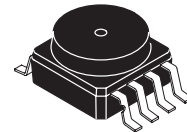

MPXV4115V6U
CASE 482

PIN NUMBER

1	N/C	5	N/C
2	V _S	6	N/C
3	Gnd	7	N/C
4	V _{out}	8	N/C

NOTE: Pins 1, 5, 6, 7, and 8 are internal device connections. Do not connect to external circuitry or ground. Pin 1 is noted by the notch in the lead.

MPXV4115V SERIES

MAXIMUM RATINGS(NOTE)

Parameters	Symbol	Value	Unit
Maximum Pressure	P_{max}	400	kPa
Storage Temperature	T_{stg}	-40 to + 125	°C
Operating Temperature	T_A	-40 to + 125	°C

NOTE: Exposure beyond the specified limits may cause permanent damage or degradation to the device.

OPERATING CHARACTERISTICS ($V_S = 5$ Vdc, $T_A = 25^\circ$ C unless otherwise noted. Decoupling circuit shown in Figure 3 required to meet electrical specifications.)

Characteristic	Symbol	Min	Typ	Max	Unit
Pressure Range (Differential mode, Vacuum on metal cap side, Atmospheric pressure on back side)	P_{OP}	-115	—	0	kPa
Supply Voltage ⁽¹⁾	V_S	4.75	5	5.25	Vdc
Supply Current	I_o	—	6.0	10	mAdc
Full Scale Output ⁽²⁾ (0 to 85° C) ($P_{diff} = 0$ kPa) ²	V_{FSO}	4.535	4.6	4.665	Vdc
Full Scale Span ⁽³⁾ (0 to 85° C) @ $V_S = 5.0$ V	V_{FSS}		4.4		Vdc
Accuracy ⁽⁴⁾ (0 to 85° C)		—	—	1.5%	% V_{FSS}
Sensitivity	V/P	—	38.26	—	mV/kPa
Response Time ⁽⁵⁾	t_R	—	1.0	—	ms
Output Source Current at Full Scale Output	I_o	—	0.1	—	mAdc
Warm-Up Time ⁽⁶⁾	—	—	20	—	ms
Offset Stability ⁽⁷⁾		—	±0.5	—	% V_{FSS}

NOTES:

- Device is ratiometric within the specified excitation voltage range.
- Full-scale output is defined as the output voltage at the maximum or full-rated pressure.
- Full-scale span is defined as the algebraic difference between the output voltage at full-rated pressure and the output voltage at the minimum-rated pressure.
- Accuracy is the deviation in actual output from nominal output over the entire pressure range and temperature range as a percent of span at 25° C due to all sources of errors, including the following:
 - Linearity: Output deviation from a straight line relationship with pressure over the specified pressure range.
 - Temperature Hysteresis: Output deviation at any temperature within the operating temperature range, after the temperature is cycled to and from the minimum or maximum operating temperature points, with zero differential pressure applied.
 - Pressure Hysteresis: Output deviation at any pressure within the specified range, when this pressure is cycled to and from minimum or maximum rated pressure at 25°C.
 - TcSpan: Output deviation over the temperature range of 0° to 85°C, relative to 25°C.
 - TcOffset: Output deviation with minimum pressure applied, over the temperature range of 0° to 85°C, relative to 25°C.
- Response Time is defined as the time for the incremental change in the output to go from 10% to 90% of its final value when subjected to a specified step change in pressure.
- Warm-up Time is defined as the time required for the product to meet the specified output voltage after the pressure has been stabilized.
- Offset Stability is the product's output deviation when subjected to 1000 cycles of Pulsed Pressure, Temperature Cycling with Bias Test.

ON-CHIP TEMPERATURE COMPENSATION, CALIBRATION AND SIGNAL CONDITIONING

The performance over temperature is achieved by integrating the shear-stress strain gauge, temperature compensation, calibration and signal conditioning circuitry onto a single monolithic chip.

Figure 2 illustrates the gauge configuration in the basic chip carrier (Case 482). A fluorosilicone gel isolates the die surface and wire bonds from the environment, while allowing the pressure signal to be transmitted to the silicon diaphragm.

The MPXV4115V series sensor operating characteristics are based on use of dry air as pressure media. Media, other than dry air, may have adverse effects on sensor performance and long-term reliability. Internal reliability and qualification test for dry air, and other media, are available from the factory. Contact the factory for information regarding media tolerance in your application.

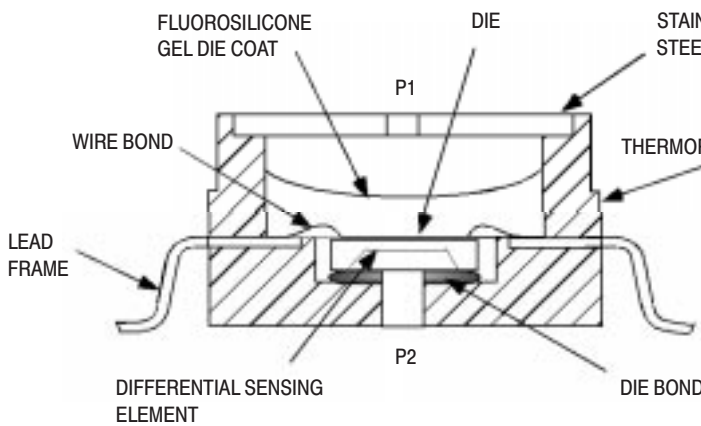

Figure 2. Cross-Sectional Diagram (Not to Scale)

Figure 3 shows the recommended decoupling circuit for interfacing the output of the integrated sensor to the A/D input of a microprocessor or microcontroller. Proper decoupling of the power supply is recommended.

Figure 4 shows the sensor output signal relative to differential pressure input. Typical, minimum and maximum output curves are shown for operation over a temperature range of 0°C to 85°C using the decoupling circuit shown in Figure 3. The output will saturate outside of the specified pressure range.

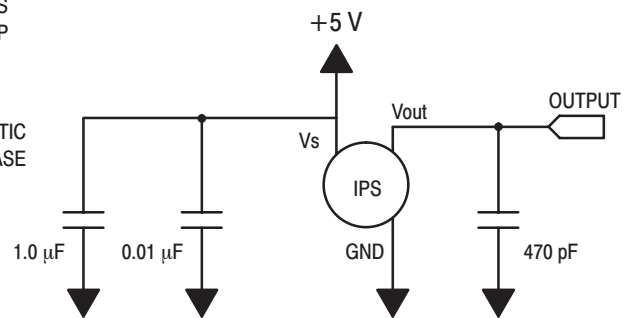

Figure 3. Recommended power supply decoupling and output filtering. For additional output filtering, please refer to Application Note AN1646.

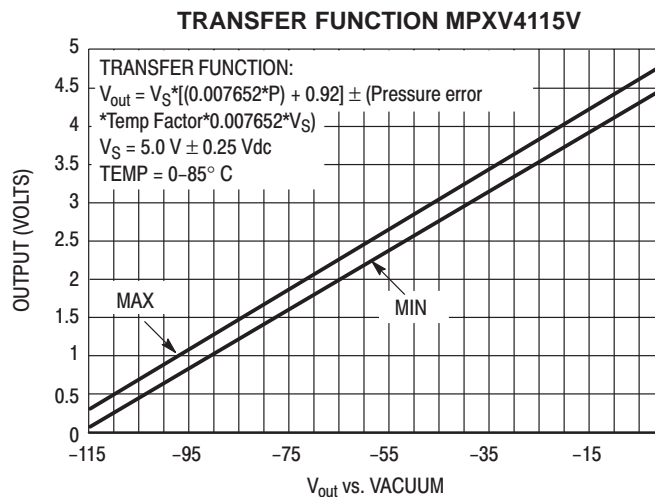

Figure 4. Applied Vacuum in kPa (below atmospheric pressure)

MPXV4115V SERIES

ORDERING INFORMATION

The MPXV4115V series pressure sensors are available in the basic element package or with a pressure port. Two packing options are also offered.

Device Type	Case No.	Packing Options	Device Marking
MPXV4115V6U	482	Rails	MPXV4115V
MPXV4115V6T1	482	Tape and Reel	MPXV4115V
MPXV4115VC6U	482A	Rails	MPXV4115V

MINIMUM RECOMMENDED FOOTPRINT FOR SURFACE MOUNTED APPLICATIONS

Surface mount board layout is a critical portion of the total design. The footprint for the surface mount packages must be the correct size to ensure proper solder connection interface between the board and the package. With the correct

footprint, the packages will self align when subjected to a solder reflow process. It is always recommended to design boards with a solder mask layer to avoid bridging and shorting between solder pads.

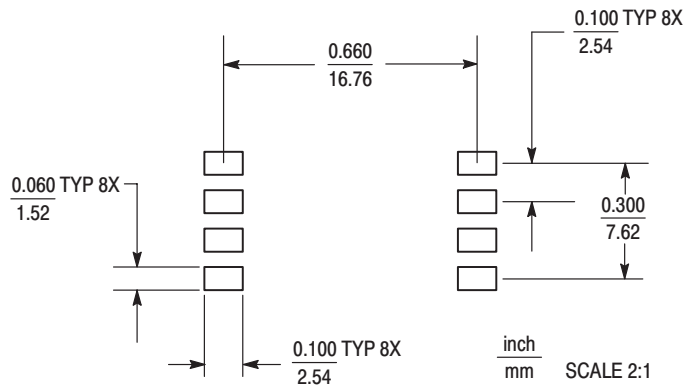
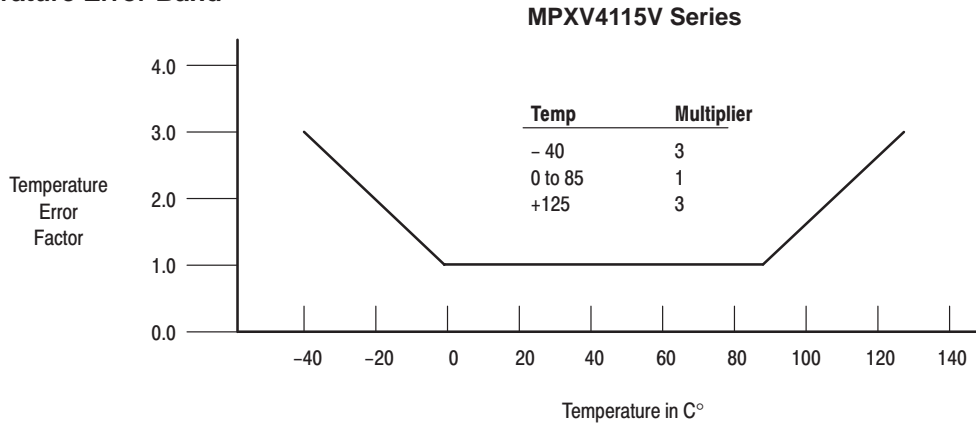

Figure 5. SOP Footprint (Case 482)

Transfer Function

Nominal Transfer Value: $V_{out} = V_S (P \times 0.007652) + 0.92$
 $\pm (\text{Pressure Error} \times \text{Temp. Factor} \times 0.007652 \times V_S)$
 $V_S = 5 \text{ V} \pm 0.25 \text{ Vdc}$

Temperature Error Band



NOTE: The Temperature Multiplier is a linear response from 0° to -40°C and from 85° to 125°C.

Pressure Error Band

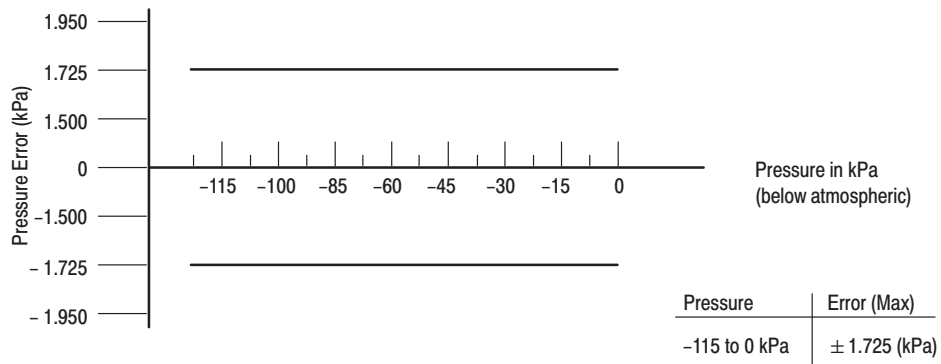

SMALL OUTLINE PACKAGE DIMENSIONS

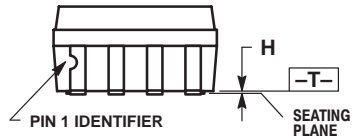
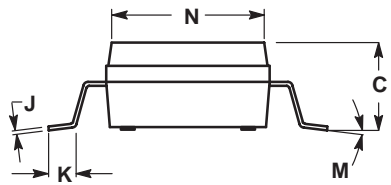
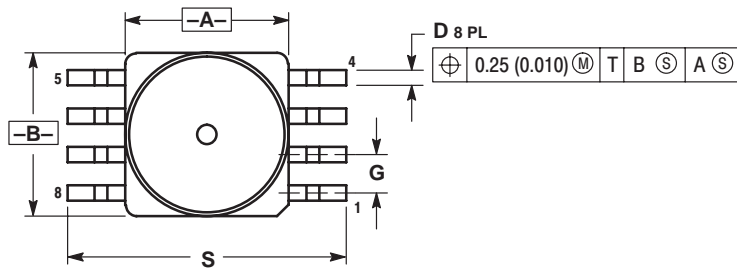

- NOTES:
1. DIMENSIONING AND TOLERANCING PER ANSI Y14.5M, 1982.
 2. CONTROLLING DIMENSION: INCH.
 3. DIMENSION A AND B DO NOT INCLUDE MOLD PROTRUSION.
 4. MAXIMUM MOLD PROTRUSION 0.15 (0.006).
 5. ALL VERTICAL SURFACES 5° TYPICAL DRAFT.

DIM	INCHES		MILLIMETERS	
	MIN	MAX	MIN	MAX
A	0.415	0.425	10.54	10.79
B	0.415	0.425	10.54	10.79
C	0.212	0.230	5.38	5.84
D	0.038	0.042	0.96	1.07
G	0.100 BSC		2.54 BSC	
H	0.002	0.010	0.05	0.25
J	0.009	0.011	0.23	0.28
K	0.061	0.071	1.55	1.80
M	0°	7°	0°	7°
N	0.405	0.415	10.29	10.54
S	0.709	0.725	18.01	18.41

CASE 482-01
ISSUE O

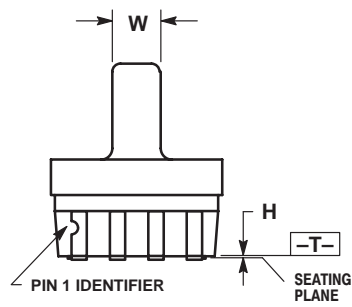
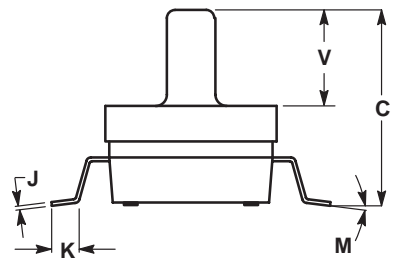
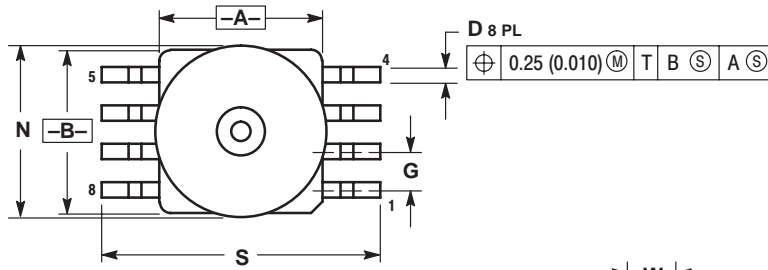

- NOTES:
1. DIMENSIONING AND TOLERANCING PER ANSI Y14.5M, 1982.
 2. CONTROLLING DIMENSION: INCH.
 3. DIMENSION A AND B DO NOT INCLUDE MOLD PROTRUSION.
 4. MAXIMUM MOLD PROTRUSION 0.15 (0.006).
 5. ALL VERTICAL SURFACES 5° TYPICAL DRAFT.

DIM	INCHES		MILLIMETERS	
	MIN	MAX	MIN	MAX
A	0.415	0.425	10.54	10.79
B	0.415	0.425	10.54	10.79
C	0.500	0.520	12.70	13.21
D	0.038	0.042	0.96	1.07
G	0.100 BSC		2.54 BSC	
H	0.002	0.010	0.05	0.25
J	0.009	0.011	0.23	0.28
K	0.061	0.071	1.55	1.80
M	0°	7°	0°	7°
N	0.444	0.448	11.28	11.38
S	0.709	0.725	18.01	18.41
V	0.245	0.255	6.22	6.48
W	0.115	0.125	2.92	3.17

CASE 482A-01
ISSUE A

Motorola reserves the right to make changes without further notice to any products herein. Motorola makes no warranty, representation or guarantee regarding the suitability of its products for any particular purpose, nor does Motorola assume any liability arising out of the application or use of any product or circuit, and specifically disclaims any and all liability, including without limitation consequential or incidental damages. "Typical" parameters which may be provided in Motorola data sheets and/or specifications can and do vary in different applications and actual performance may vary over time. All operating parameters, including "Typicals" must be validated for each customer application by customer's technical experts. Motorola does not convey any license under its patent rights nor the rights of others. Motorola products are not designed, intended, or authorized for use as components in systems intended for surgical implant into the body, or other applications intended to support or sustain life, or for any other application in which the failure of the Motorola product could create a situation where personal injury or death may occur. Should Buyer purchase or use Motorola products for any such unintended or unauthorized application, Buyer shall indemnify and hold Motorola and its officers, employees, subsidiaries, affiliates, and distributors harmless against all claims, costs, damages, and expenses, and reasonable attorney fees arising out of, directly or indirectly, any claim of personal injury or death associated with such unintended or unauthorized use, even if such claim alleges that Motorola was negligent regarding the design or manufacture of the part. Motorola and  are registered trademarks of Motorola, Inc. Motorola, Inc. is an Equal Opportunity/Affirmative Action Employer.

How to reach us:

USA/EUROPE/Locations Not Listed: Motorola Literature Distribution;
P.O. Box 5405, Denver, Colorado 80217. 1-303-675-2140 or 1-800-441-2447

JAPAN: Motorola Japan Ltd.; SPS, Technical Information Center, 3-20-1,
Minami-Azabu, Minato-ku, Tokyo 106-8573 Japan. 81-3-3440-3569

Technical Information Center: 1-800-521-6274

ASIA/PACIFIC: Motorola Semiconductors H.K. Ltd.; Silicon Harbour Centre,
2, Dai King Street, Tai Po Industrial Estate, Tai Po, N.T., Hong Kong.
852-26668334

HOME PAGE: <http://www.motorola.com/semiconductors/>

**MOTOROLA****MPXV4115V/D**