

NCP4300A

Dual Operational Amplifier and Voltage Reference

The NCP4300A is a monolithic integrated circuit specifically designed to control the output current and voltage levels of switch mode battery chargers and power supplies. This device contains a precision 2.6 V shunt reference and two operational amplifiers. Op-Amp 1 is designed to perform voltage control and has its non-inverting input internally connected to the reference. Op-Amp 2 is designed for current control and has both inputs uncommitted. The NCP4300A offers the power converter designer a control solution that features increased precision with a corresponding reduction in system complexity and cost. This device is available in an 8-lead surface mount package.

Features

Operational Amplifier

- Low Input Offset Voltage: 0.5 mV
- Input Common Mode Voltage Range Includes Ground
- Low Supply Current: 210 μ A/Op-Amp (@ $V_{CC} = 5.0$ V)
- Medium Unity Gain Bandwidth: 0.7 MHz
- Large Output Voltage Swing: 0 V to $V_{CC} - 1.5$ V
- Wide Power Supply Voltage Range: 3.0 V to 35 V

Voltage Reference

- Fixed Output Voltage Reference: 2.60 V
- High Precision Over Temperature: 1.0%
- Wide Sink Current Range: 80 μ A to 80 mA

Typical Applications

- Battery Charger
- Switch Mode Power Supply

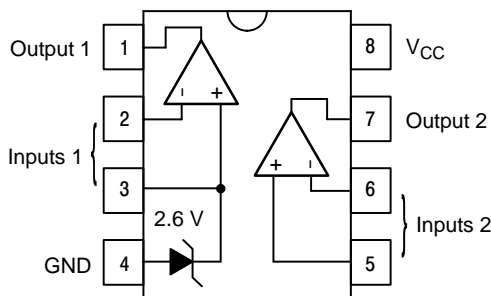
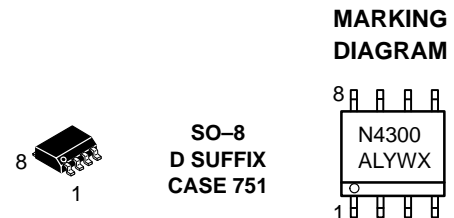

Figure 1. Functional Block Diagram



ON Semiconductor™

<http://onsemi.com>



A = Assembly Location
 L = Wafer Lot
 Y = Year
 W = Work Week
 X = Option Code = A

PIN CONNECTIONS

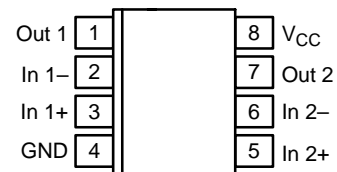

(Top View)

ORDERING INFORMATION

Device	Package	Shipping
NCP4300ADR2	SO-8	2500/Tape & Reel

NCP4300A

ABSOLUTE MAXIMUM RATINGS

Rating	Symbol	Value	Unit
Supply Voltage (V_{CC} to GND)	V_{CC}	36	V
ESD Protection Voltage at any Pin (Human Body Model)	V_{ESD}	2.0 K (min)	V
Op-Amp 1 and 2 Input Voltage Range (Pins 2, 5, 6)	V_{IR}	-0.6 to $V_{CC} + 0.6$	V
Op-Amp 2 Input Differential Voltage Range (Pins 5, 6)	V_{IDR}	V_{CC} to GND	V
Voltage Reference Cathode Current (Pin 3)	I_K	100	mA
Maximum Junction Temperature	T_J	150	°C
Operating Ambient Temperature Range	T_A	0 to 105	°C
Storage Temperature Range	T_{stg}	-55 to 150	°C

THERMAL CHARACTERISTICS

Rating	Symbol	Value	Unit
Thermal Resistance, Junction to Ambient	$R_{\theta JA}$	155	°C/W
Thermal Resistance, Junction to Case	$R_{\theta JC}$	45	°C/W

TYPICAL ELECTRICAL CHARACTERISTICS

Characteristic	Symbol	Min	Typ	Max	Unit
Total Supply Current, excluding Current in the Voltage Reference $V_{CC} = 5.0$ V, no load; $0^\circ\text{C} \leq T_A \leq 105^\circ\text{C}$	I_{CC}	-	0.42	0.8	mA

Op-Amp 1 (Op-amp with non-inverting input connected to the internal Vref)

($V_{CC} = 5.0$ V, $V_{out} = 1.4$ V, $T_A = 25^\circ\text{C}$, unless otherwise noted)

Input Offset Voltage $T_A = 25^\circ\text{C}$ $T_A = 0^\circ\text{C}$ to 105°C	V_{IO}	-	0.5	2.0	mV
Input Offset Voltage Temperature Coefficient $T_A = 0^\circ\text{C}$ to 105°C	$\Delta V_{IO}/\Delta T$	-	7.0	-	$\mu\text{V}/^\circ\text{C}$
Input Bias Current (Inverting input only) $T_A = 25^\circ\text{C}$ $T_A = 0^\circ\text{C}$ to 105°C	I_{IB}	-	-50	-150	nA
Large Signal Voltage Gain ($V_{CC} = 15$ V, $R_L = 2.0$ k Ω , $V_{out} = 1.4$ V to 11.4 V) $T_A = 25^\circ\text{C}$ $T_A = 0^\circ\text{C}$ to 105°C	A_{VOL}	50	100	-	V/mV
Power Supply Rejection ($V_{CC} = 5.0$ V to 30 V)	PSRR	40	90	-	dB
Output Source Current ($V_{CC} = 15$ V, $V_{out} = 2.0$ V, $V_{ID} = +1.0$ V)	I_{O+}	10	16	-	mA
Output Sink Current ($V_{CC} = 15$ V, $V_{out} = 2.0$ V, $V_{ID} = -1.0$ V)	I_{O-}	10	25	-	mA
Output Voltage Swing, High ($V_{CC} = 30$ V, $R_L = 10$ k Ω , $V_{ID} = +1.0$ V) $T_A = 25^\circ\text{C}$ $T_A = 0^\circ\text{C}$ to 105°C	V_{OH}	27	28	-	V
Output Voltage Swing, Low ($R_L = 10$ k Ω , $V_{ID} = -1.0$ V) $T_A = 25^\circ\text{C}$ $T_A = 0^\circ\text{C}$ to 105°C	V_{OL}	-	17	100	mV
Slew Rate ($V_{in} = 0.5$ to 2.0 V, $V_{CC} = 15$ V, $R_L = 2.0$ k Ω , $A_v = 1.0$, $C_L = 100$ pF)	SR	0.3	0.5	-	V/ μs
Unity Gain Bandwidth ($V_{CC} = 30$ V, $R_L = 2.0$ k Ω , $C_L = 100$ pF, $V_{in} = 0.5$ V _{pp} @ $f = 70$ kHz)	BW	0.3	0.7	-	MHz
Total Harmonic Distortion ($f = 1.0$ kHz, $A_v = 10$, $R_L = 2.0$ k Ω , $V_{CC} = 30$ V, $V_{out} = 2.0$ V _{pp})	THD	-	0.02	-	%

NCP4300A

TYPICAL ELECTRICAL CHARACTERISTICS (continued)

Characteristic	Symbol	Min	Typ	Max	Unit
Op–Amp 2 (Independent op–amp) ($V_{CC} = 5.0\text{ V}$, $V_{out} = 1.4\text{ V}$, $T_A = 25^\circ\text{C}$, unless otherwise noted)					
Input Offset Voltage $T_A = 25^\circ\text{C}$ $T_A = 0^\circ\text{C to } 105^\circ\text{C}$	V_{IO}	– –	0.5 –	2.0 3.0	mV
Input Offset Voltage Temperature Coefficient $T_A = 0^\circ\text{C to } 105^\circ\text{C}$	$\Delta V_{IO}/\Delta T$	–	7.0	–	$\mu\text{V}/^\circ\text{C}$
Input Offset Current $T_A = 25^\circ\text{C}$ $T_A = 0^\circ\text{C to } 105^\circ\text{C}$	I_{IO}	– –	2.0 –	30 30	nA
Input Bias Current $T_A = 25^\circ\text{C}$ $T_A = 0^\circ\text{C to } 105^\circ\text{C}$	I_{IB}	– –	–50 –	–150 –150	nA
Input Common Mode Voltage Range ($V_{CC} = 0\text{ V to } 35\text{ V}$)	V_{ICR}	–	0 to $V_{CC} - 1.5$	–	V
Large Signal Voltage Gain ($V_{CC} = 15\text{ V}$, $R_L = 2.0\text{ k}\Omega$, $V_{out} = 1.4\text{ V to } 11.4\text{ V}$) $T_A = 25^\circ\text{C}$ $T_A = 0^\circ\text{C to } 105^\circ\text{C}$	A_{VOL}	50 25	100 –	– –	V/mV
Power Supply Rejection ($V_{CC} = 5.0\text{ V to } 30\text{ V}$)	PSRR	40	90	–	dB
Common Mode Rejection ($V_{CM} = 0\text{ V to } 3.5\text{ V}$) $T_A = 25^\circ\text{C}$ $T_A = 0^\circ\text{C to } 105^\circ\text{C}$	CMRR	40 30	60 –	– –	dB
Output Source Current ($V_{CC} = 15\text{ V}$, $V_{out} = 2.0\text{ V}$, $V_{ID} = +1.0\text{ V}$)	I_{O+}	10	16	–	mA
Output Sink Current ($V_{CC} = 15\text{ V}$, $V_{out} = 2.0\text{ V}$, $V_{ID} = -1.0\text{ V}$)	I_{O-}	10	25	–	mA
Output Voltage Swing, High ($V_{CC} = 30\text{ V}$, $R_L = 10\text{ k}\Omega$, $V_{ID} = +1.0\text{ V}$) $T_A = 25^\circ\text{C}$ $T_A = 0^\circ\text{C to } 105^\circ\text{C}$	V_{OH}	27 27	28 –	– –	V
Output Voltage Swing, Low ($R_L = 10\text{ k}\Omega$, $V_{ID} = -1.0\text{ V}$) $T_A = 25^\circ\text{C}$ $T_A = 0^\circ\text{C to } 105^\circ\text{C}$	V_{OL}	– –	17 –	100 100	mV
Slew Rate ($V_{in} = 0.5\text{ to } 3.0\text{ V}$, $V_{CC} = 15\text{ V}$, $R_L = 2.0\text{ k}\Omega$, $A_v = 1.0$, $C_L = 100\text{ pF}$)	SR	0.3	0.5	–	V/ μs
Unity Gain Bandwidth ($V_{CC} = 30\text{ V}$, $R_L = 2.0\text{ k}\Omega$, $C_L = 100\text{ pF}$, $V_{in} = 0.5\text{ V}_{pp}$ @ $f = 70\text{ kHz}$)	BW	0.3	0.7	–	MHz
Total Harmonic Distortion ($f = 1.0\text{ kHz}$, $A_v = 10$, $R_L = 2.0\text{ k}\Omega$, $V_{CC} = 30\text{ V}$, $V_{out} = 2.0\text{ V}_{PP}$)	THD	–	0.02	–	%

Voltage Reference

Reference Voltage ($I_K = 10\text{ mA}$) $T_A = 25^\circ\text{C}$ $T_A = 0^\circ\text{C to } 105^\circ\text{C}$	V_{ref}	– 2.574	2.60 2.60	– 2.626	V
Reference Input Voltage Deviation Over Full Temperature Range ($I_K = 10\text{ mA}$, $T_A = 0^\circ\text{C to } 105^\circ\text{C}$)	ΔV_{ref}	–	5.0	22	mV
Minimum Cathode Current for Regulation	$I_{K(min)}$	–	55	80	μA
Dynamic Impedance $T_A = 25^\circ\text{C}$, $I_K = 1.0\text{ to } 80\text{ mA}$, $f < 1.0\text{ kHz}$ $T_A = 0^\circ\text{C to } 125^\circ\text{C}$, $I_K = 1.0\text{ mA to } 60\text{ mA}$, $f < 1.0\text{ kHz}$	$ Z_{KA} $	– –	0.3 –	0.5 0.6	Ω

NCP4300A

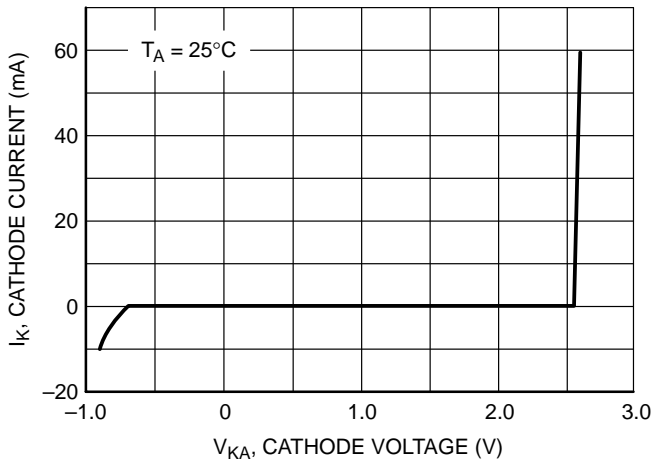

Figure 2. Reference Cathode Current vs. Cathode Voltage

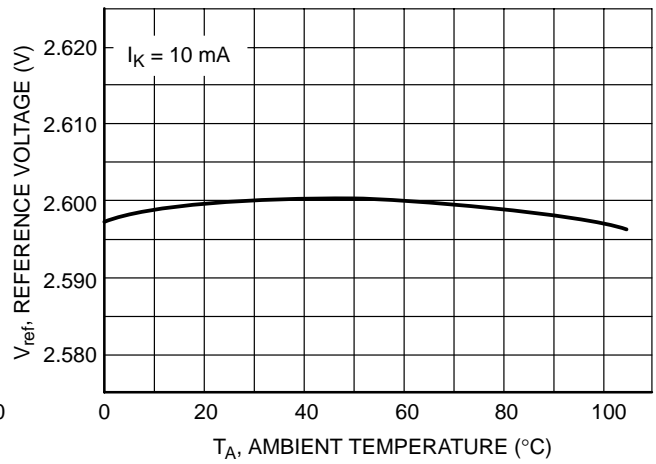

Figure 3. Reference Voltage vs. Ambient Temperature

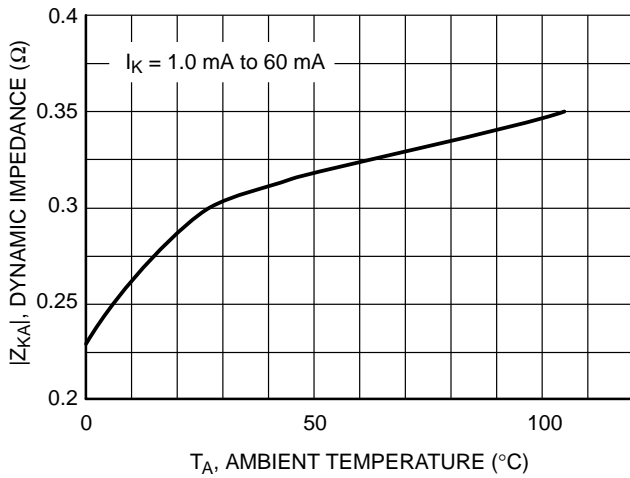

Figure 4. Reference Dynamic Impedance vs. Ambient Temperature

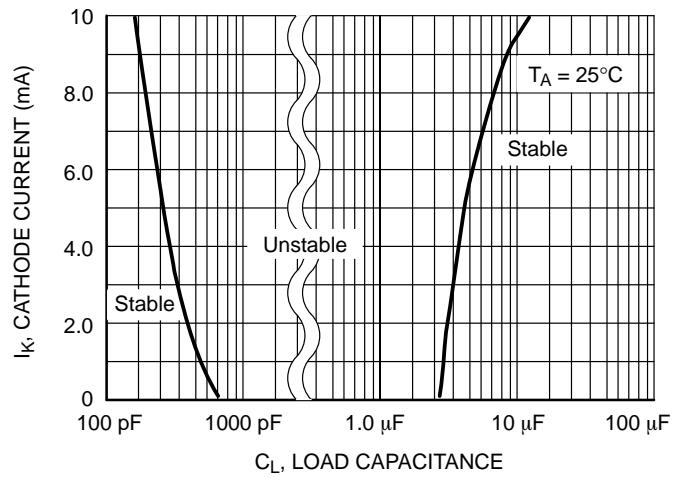

Figure 5. Reference Stability vs. Load Capacitance

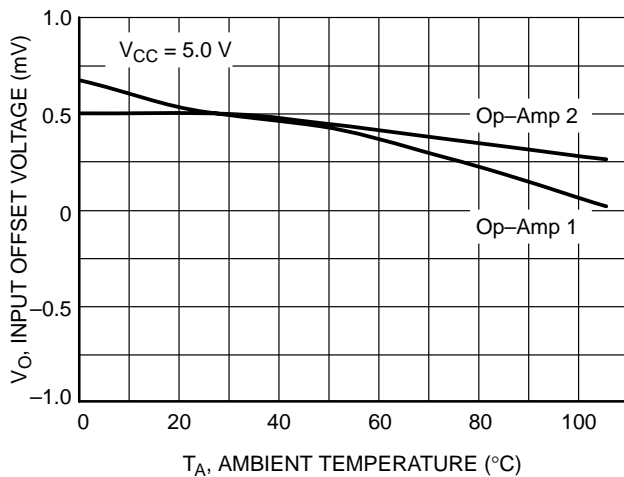

Figure 6. Input Offset Voltage vs. Ambient Temperature

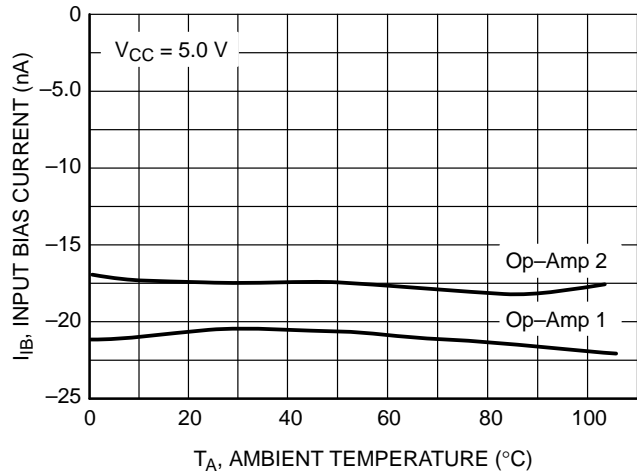

Figure 7. Input Bias Current vs. Ambient Temperature

NCP4300A

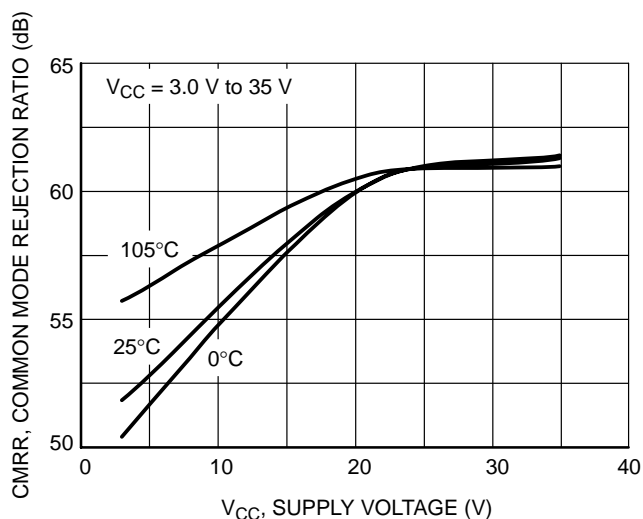

Figure 8. Common Mode Rejection Ratio vs. Supply Voltage

DETAILED OPERATING DESCRIPTION

INTRODUCTION

Power supplies and battery chargers require precise control of output voltage and current in order to prevent catastrophic damage to the system connected. Many present day power sources contain a wide assortment of building blocks and glue devices to perform the required sensing for proper regulation. Typical feedback loop circuits may consist of a voltage and current amplifier, summing circuitry and a reference. The NCP4300A contains all of these basic functions in a manner that is easily adaptable to many of the various power source-load configurations.

OPERATING DESCRIPTION

The NCP4300A is an analog regulation control circuit that is designed to simultaneously close the voltage and current feedback loops in power supply and battery charger applications. This device can control the feedback loop in either constant-voltage (CV) or constant-current (CC) mode with smooth crossover. A concise description of the integrated circuit blocks is given in below. The functional block diagram of the IC is shown in Figure 1.

Internal Reference

An internal precision band gap reference is used to set the 2.6 V voltage threshold and current threshold setting. The

reference is initially trimmed to a $\pm 0.5\%$ tolerance at $T_A = 25^\circ\text{C}$ and is guaranteed to be within $\pm 1.0\%$ over an ambient temperature range of 0°C to 105°C .

Voltage Sensing Operational Amplifier (Op-Amp 1)

The internal Op-Amp 1 is designed to perform the voltage control function. The non-inverting input of the op-amp is connected to the precision voltage reference internally. The inverting input of the op-amp monitors the voltage information derived from the system output. As the control threshold is internally connected to the voltage reference, the voltage regulation threshold is fixed at 2.6 V. For any output voltage from 2.6 V up to the maximum limit can be configured with an external resistor divider. The output terminal of Op-Amp 1 (pin 1) provides the error signal for output voltage control. The output pin also provides a means for external compensation.

Independent Operational Amplifier (Op-Amp 2)

The internal Op-Amp 2 is configured as a general purpose op-amp with all terminals available for the user. With the low offset voltage provided, 0.5 mV, this op-amp can be used for current sensing in a constant current regulator.

NCP4300A

PACKAGE DIMENSIONS

SO-8
D SUFFIX
CASE 751-07
ISSUE W

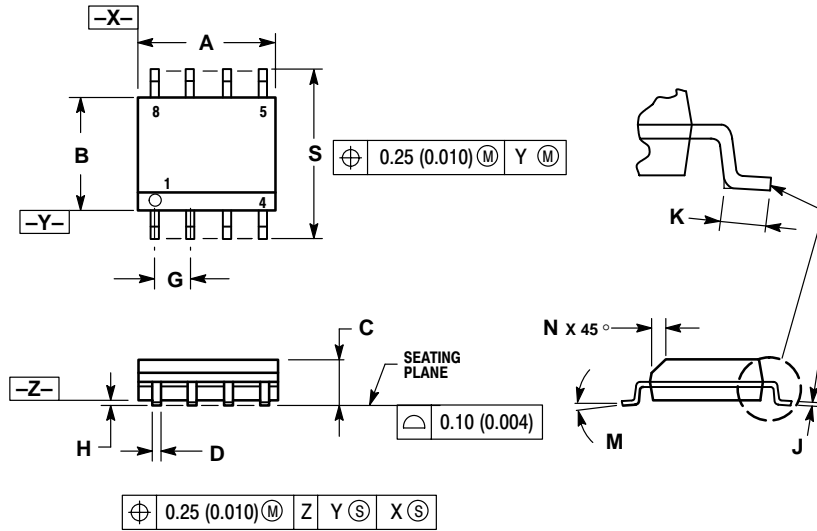

NOTES:

1. DIMENSIONING AND TOLERANCING PER ANSI Y14.5M, 1982.
2. CONTROLLING DIMENSION: MILLIMETER.
3. DIMENSION A AND B DO NOT INCLUDE MOLD PROTRUSION.
4. MAXIMUM MOLD PROTRUSION 0.15 (0.006) PER SIDE.
5. DIMENSION D DOES NOT INCLUDE DAMBAR PROTRUSION. ALLOWABLE DAMBAR PROTRUSION SHALL BE 0.127 (0.005) TOTAL IN EXCESS OF THE D DIMENSION AT MAXIMUM MATERIAL CONDITION.

DIM	MILLIMETERS		INCHES	
	MIN	MAX	MIN	MAX
A	4.80	5.00	0.189	0.197
B	3.80	4.00	0.150	0.157
C	1.35	1.75	0.053	0.069
D	0.33	0.51	0.013	0.020
G	1.27 BSC		0.050 BSC	
H	0.10	0.25	0.004	0.010
J	0.19	0.25	0.007	0.010
K	0.40	1.27	0.016	0.050
M	0°	8°	0°	8°
N	0.25	0.50	0.010	0.020
S	5.80	6.20	0.228	0.244

ON Semiconductor and  are trademarks of Semiconductor Components Industries, LLC (SCILLC). SCILLC reserves the right to make changes without further notice to any products herein. SCILLC makes no warranty, representation or guarantee regarding the suitability of its products for any particular purpose, nor does SCILLC assume any liability arising out of the application or use of any product or circuit, and specifically disclaims any and all liability, including without limitation special, consequential or incidental damages. "Typical" parameters which may be provided in SCILLC data sheets and/or specifications can and do vary in different applications and actual performance may vary over time. All operating parameters, including "Typicals" must be validated for each customer application by customer's technical experts. SCILLC does not convey any license under its patent rights nor the rights of others. SCILLC products are not designed, intended, or authorized for use as components in systems intended for surgical implant into the body, or other applications intended to support or sustain life, or for any other application in which the failure of the SCILLC product could create a situation where personal injury or death may occur. Should Buyer purchase or use SCILLC products for any such unintended or unauthorized application, Buyer shall indemnify and hold SCILLC and its officers, employees, subsidiaries, affiliates, and distributors harmless against all claims, costs, damages, and expenses, and reasonable attorney fees arising out of, directly or indirectly, any claim of personal injury or death associated with such unintended or unauthorized use, even if such claim alleges that SCILLC was negligent regarding the design or manufacture of the part. SCILLC is an Equal Opportunity/Affirmative Action Employer.

PUBLICATION ORDERING INFORMATION

NORTH AMERICA Literature Fulfillment:

Literature Distribution Center for ON Semiconductor
P.O. Box 5163, Denver, Colorado 80217 USA
Phone: 303-675-2175 or 800-344-3860 Toll Free USA/Canada
Fax: 303-675-2176 or 800-344-3867 Toll Free USA/Canada
Email: ONlit@hibbertco.com
Fax Response Line: 303-675-2167 or 800-344-3810 Toll Free USA/Canada

N. American Technical Support: 800-282-9855 Toll Free USA/Canada

EUROPE: LDC for ON Semiconductor – European Support

German Phone: (+1) 303-308-7140 (Mon-Fri 2:30pm to 7:00pm CET)
Email: ONlit-german@hibbertco.com
French Phone: (+1) 303-308-7141 (Mon-Fri 2:00pm to 7:00pm CET)
Email: ONlit-french@hibbertco.com
English Phone: (+1) 303-308-7142 (Mon-Fri 12:00pm to 5:00pm GMT)
Email: ONlit@hibbertco.com

EUROPEAN TOLL-FREE ACCESS*: 00-800-4422-3781

*Available from Germany, France, Italy, UK, Ireland

CENTRAL/SOUTH AMERICA:

Spanish Phone: 303-308-7143 (Mon-Fri 8:00am to 5:00pm MST)
Email: ONlit-spanish@hibbertco.com
Toll-Free from Mexico: Dial 01-800-288-2872 for Access –
then Dial 866-297-9322

ASIA/PACIFIC: LDC for ON Semiconductor – Asia Support

Phone: 1-303-675-2121 (Tue-Fri 9:00am to 1:00pm, Hong Kong Time)
Toll Free from Hong Kong & Singapore:
001-800-4422-3781
Email: ONlit-asia@hibbertco.com

JAPAN: ON Semiconductor, Japan Customer Focus Center

4-32-1 Nishi-Gotanda, Shinagawa-ku, Tokyo, Japan 141-0031
Phone: 81-3-5740-2700
Email: r14525@onsemi.com

ON Semiconductor Website: <http://onsemi.com>

For additional information, please contact your local Sales Representative.