

N-CHANNEL MOSFET WITH SCHOTTKY BARRIER DIODE FOR SWITCHING

DESCRIPTION

The μPA2680T1E is a switching device, which can be driven directly by a 4.5 V power source.

The μPA2680T1E incorporates a MOSFET which features a low on-state resistance and excellent switching characteristics and a low forward voltage Schottky Barrier Diode, and is suitable for applications such as DC/DC converter of portable machine and so on.

FEATURES

- 4.5 V drive available MOSFET
- Low on-state resistance MOSFET
 $R_{DS(on)1} = 38 \text{ m}\Omega$ TYP. ($V_{GS} = 10 \text{ V}$, $I_D = 3.0 \text{ A}$)
 $R_{DS(on)2} = 44 \text{ m}\Omega$ TYP. ($V_{GS} = 4.5 \text{ V}$, $I_D = 3.0 \text{ A}$)
- Low forward voltage Schottky Barrier Diode
 $V_F = 0.36 \text{ V}$ TYP. ($I_F = 1.0 \text{ A}$)

ORDERING INFORMATION

PART NUMBER	PACKAGE
μPA2680T1E	6LD3x3MLP

Marking: A2680

Remark The diode connected between the gate and source of the transistor serves as a protector against ESD. When this device actually used, an additional protection circuit is externally required if a voltage exceeding the rated voltage may be applied to this device.

Caution This product is electrostatic-sensitive device due to low ESD capability and should be handled with caution for electrostatic discharge.

$V_{ESD} = \pm 150 \text{ V}$ TYP. ($C = 200 \text{ pF}$, $R = 0 \Omega$, Single Pulse)

PIN CONNECTION (Top View)

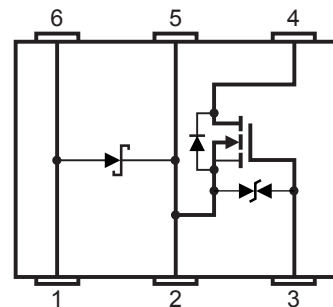

- 1: Anode
- 2: Source/Cathode (Heat sink 2)
- 3: Gate
- 4: Drain (Heat sink 1)
- 5: Source/Cathode (Heat sink 2)
- 6: Anode

The information in this document is subject to change without notice. Before using this document, please confirm that this is the latest version.
 Not all products and/or types are available in every country. Please check with an NEC Electronics sales representative for availability and additional information.

ABSOLUTE MAXIMUM RATINGS (T_A = 25°C, unless otherwise specified)

MOSFET

Drain to Source Voltage (V _{GS} = 0 V)	V _{DSS}	20	V
Gate to Source Voltage (V _{DS} = 0 V)	V _{GSS}	±12	V
Drain Current (DC) ^{Note1}	I _{D(DC)}	±3.0	A
Drain Current (pulse) ^{Note2}	I _{D(pulse)}	±12.0	A
Total Power Dissipation ^{Note1}	P _T	1.3	W
Channel Temperature	T _{ch}	150	°C
Storage Temperature	T _{stg}	-55 to +150	°C

- Notes** 1. Mounted on a 1 in² pad of 2 oz copper, 1.5" x 1.5" x 0.062" thick FR-4 board
 (Cu pad: 322 mm² x 70 μm, FR-4: 1452 mm² x 1.6 mmt)
 2. PW ≤ 10 μs, Duty Cycle ≤ 1%

Schottky Barrier Diode

Repetitive Peak Reverse Voltage	V _{RRM}	20	V
Average Forward Current ^{Note}	I _F	1.8	A
Total Power Dissipation ^{Note}	P _T	1.2	W
Junction Temperature	T _J	125	°C
Storage Temperature	T _{stg}	-55 to +150	°C

- Note** Square wave, Duty Cycle = 50%
 Mounted on a 1 in² pad of 2 oz copper, 1.5" x 1.5" x 0.062" thick FR-4 board
 (Cu pad: 322 mm² x 70 μm, FR-4: 1452 mm² x 1.6 mmt)

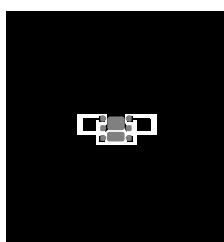

SBD side: 85°C/W when mounted on a 1 in² pad of 2 oz copper

FET side: 97°C/W when mounted on a 1 in² pad of 2 oz copper

ELECTRICAL CHARACTERISTICS (TA = 25°C, unless otherwise specified)

MOSFET

CHARACTERISTICS	SYMBOL	TEST CONDITIONS	MIN.	TYP.	MAX.	UNIT
Zero Gate Voltage Drain Current	I _{DSS}	V _{DS} = 20 V, V _{GS} = 0 V			1	μA
Gate Leakage Current	I _{GSS}	V _{GS} = ±12 V, V _{DS} = 0 V			±10	μA
Gate to Source Threshold Voltage	V _{GS(th)}	V _{DS} = V _{GS} , I _D = 0.25 mA	0.6		2.0	V
Forward Transfer Admittance Note	y _{fs}	V _{DS} = 10 V, I _D = 1.5 A	1.0	3.6		S
Drain to Source On-state Resistance Note	R _{DS(on)1}	V _{GS} = 10 V, I _D = 3.0 A		38	50	mΩ
	R _{DS(on)2}	V _{GS} = 4.5 V, I _D = 3.0 A		44	60	mΩ
Input Capacitance	C _{iss}	V _{DS} = 10 V,		190		pF
Output Capacitance	C _{oss}	V _{GS} = 0 V,		90		pF
Reverse Transfer Capacitance	C _{rss}	f = 1.0 MHz		33		pF
Turn-on Delay Time	t _{d(on)}	V _{DD} = 10 V, I _D = 1.5 A,		9.0		ns
Rise Time	t _r	V _{GS} = 4.5 V,		7.0		ns
Turn-off Delay Time	t _{d(off)}	R _G = 10 Ω		16		ns
Fall Time	t _f			4.0		ns
Total Gate Charge	Q _G	V _{DD} = 16 V,		3.1		nC
Gate to Source Charge	Q _{GS}	V _{GS} = 4.5 V,		0.6		nC
Gate to Drain Charge	Q _{GD}	I _D = 2.0 A		1.1		nC
Body Diode Forward Voltage Note	V _{F(S-D)}	I _F = 3.0 A, V _{GS} = 0 V		0.85		V

Note Pulsed: PW ≤ 350 μs, Duty Cycle ≤ 2%

TEST CIRCUIT 1 SWITCHING TIME

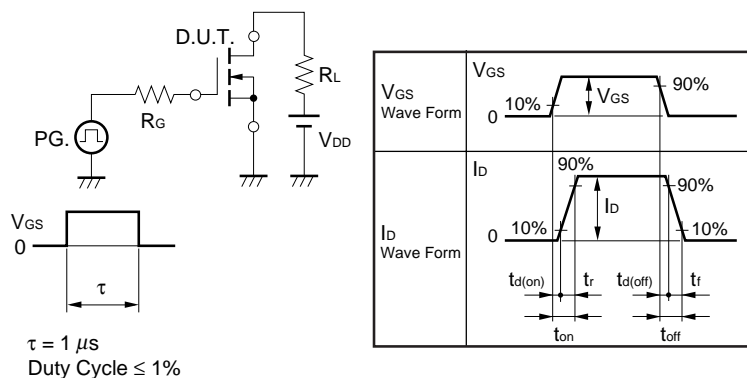

TEST CIRCUIT 2 GATE CHARGE

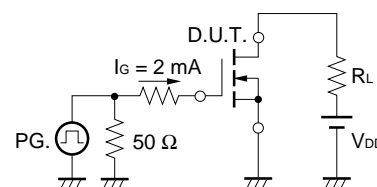

Schottky Barrier Diode

CHARACTERISTICS	SYMBOL	TEST CONDITIONS	MIN.	TYP.	MAX.	UNIT
Forward Voltage	V _F	I _F = 1.0 A		0.36	0.39	V
Reverse Current	I _R	V _R = 5 V, T _A = 100°C			15	mA
Terminal Capacitance	C _T	f = 1.0 MHz, V _R = 10 V		36		pF

MOSFET TYPICAL CHARACTERISTICS ($T_A = 25^\circ\text{C}$, unless otherwise specified)

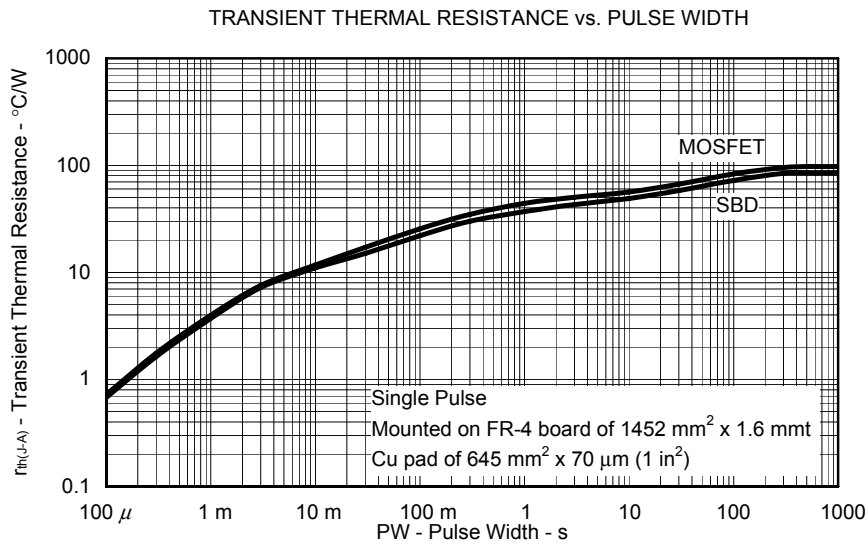
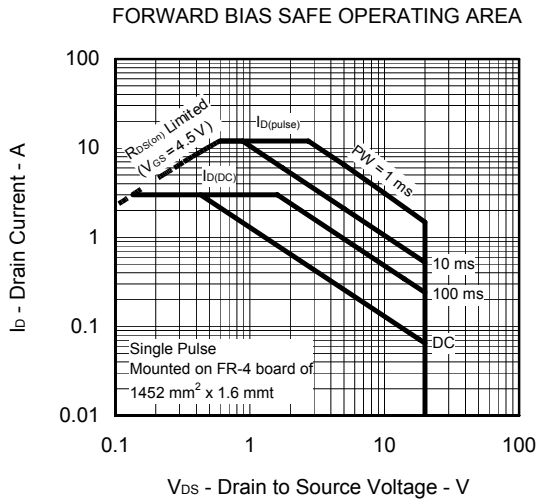
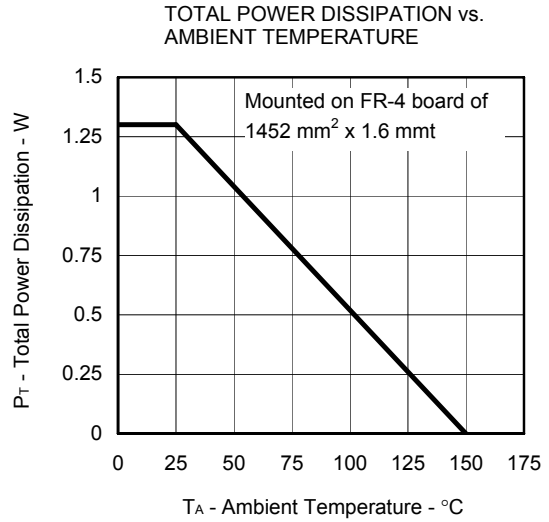
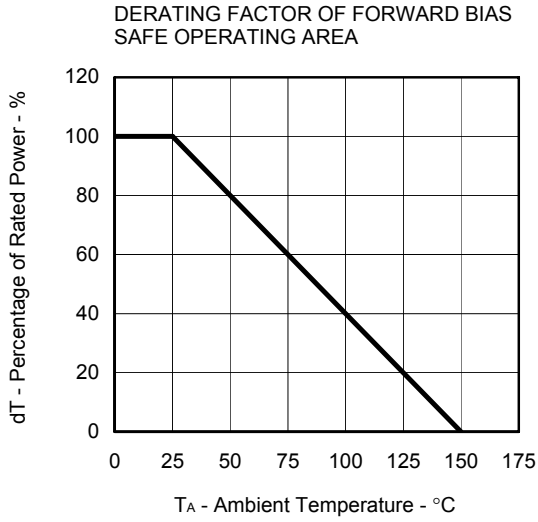

DRAIN CURRENT vs. DRAIN TO SOURCE VOLTAGE

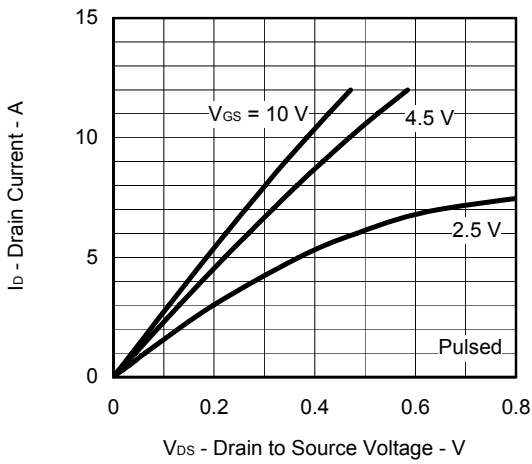

FORWARD TRANSFER CHARACTERISTICS

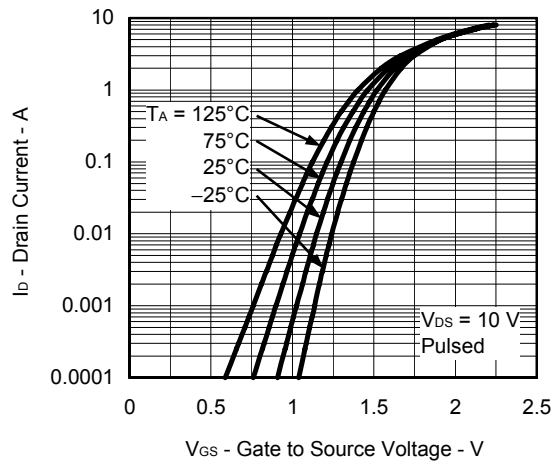

GATE TO SOURCE THRESHOLD VOLTAGE vs. CHANNEL TEMPERATURE

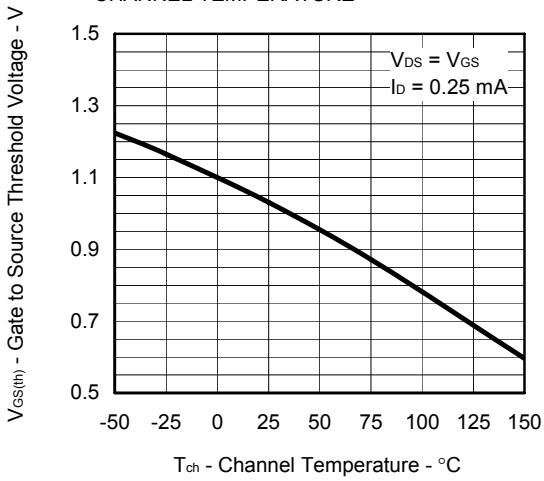

GATE TO SOURCE CUT-OFF VOLTAGE vs. CHANNEL TEMPERATURE

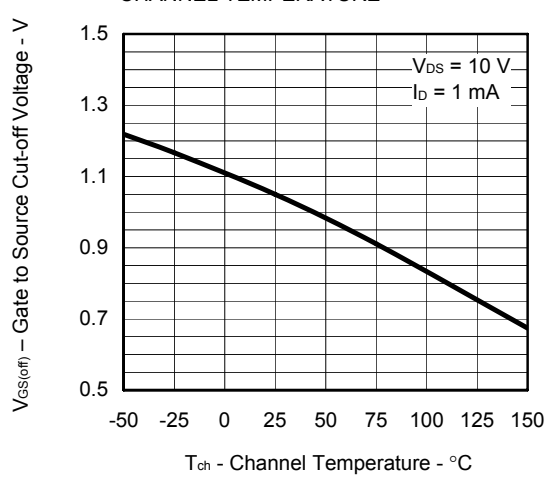

FORWARD TRANSFER ADMITTANCE vs. DRAIN CURRENT

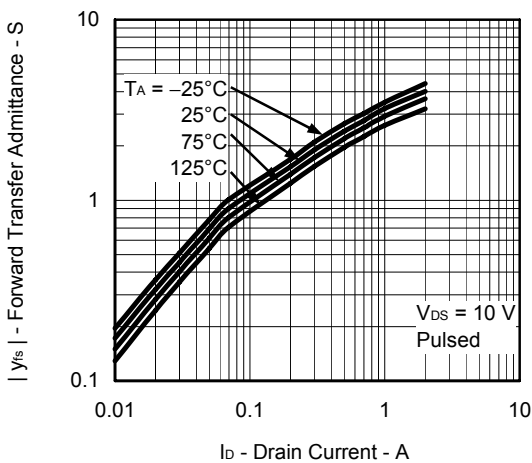

DRAIN TO SOURCE ON-STATE RESISTANCE vs. DRAIN CURRENT

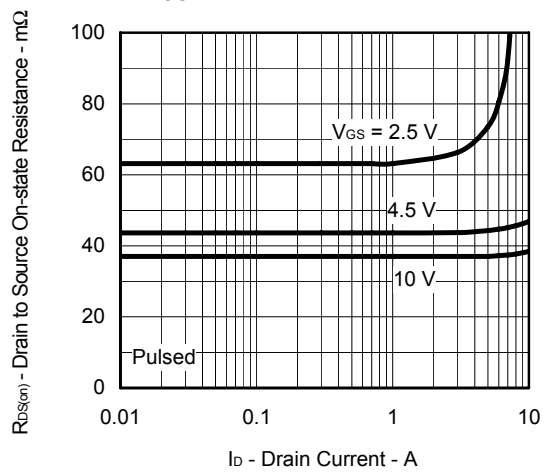

DRAIN TO SOURCE ON-STATE RESISTANCE vs. GATE TO SOURCE VOLTAGE

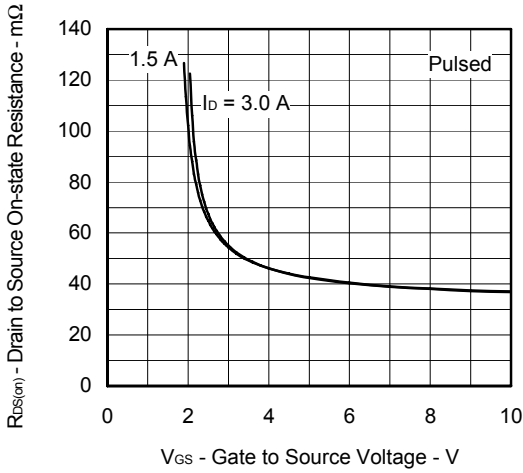

DRAIN TO SOURCE ON-STATE RESISTANCE vs. CHANNEL TEMPERATURE

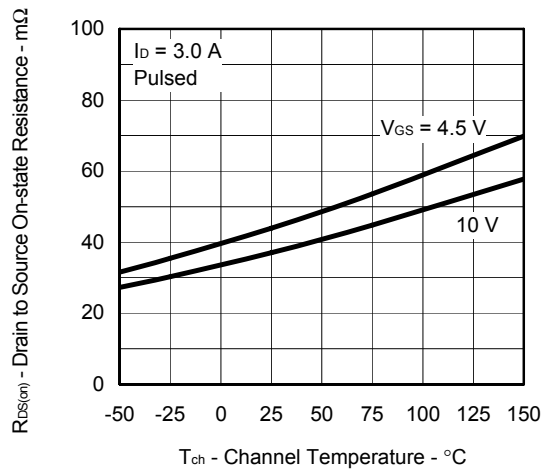

CAPACITANCE vs. DRAIN TO SOURCE VOLTAGE

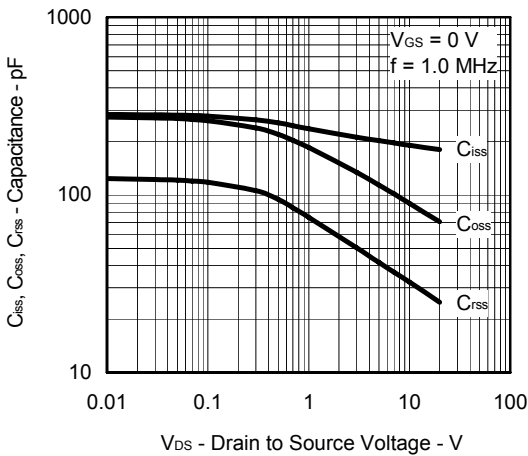

SWITCHING CHARACTERISTICS

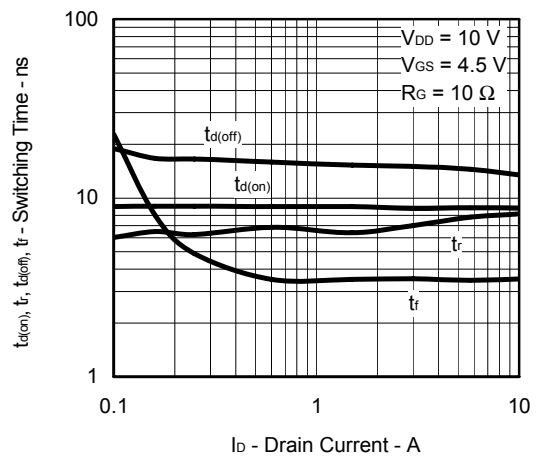

DYNAMIC INPUT CHARACTERISTICS

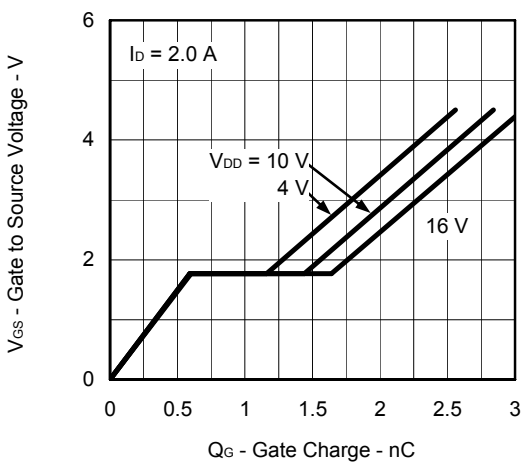

SOURCE TO DRAIN DIODE FORWARD VOLTAGE

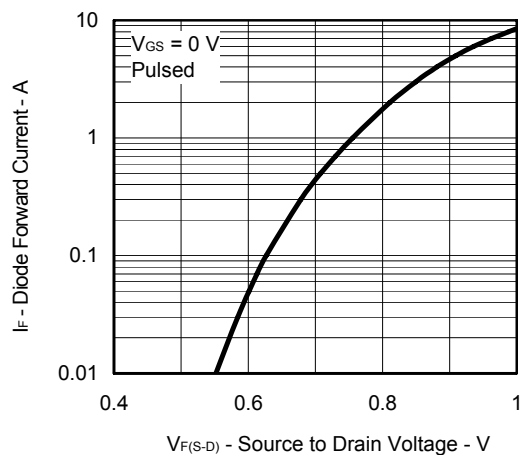

SCHOTTKY BARRIER DIODE TYPICAL CHARACTERISTICS ($T_A = 25^\circ\text{C}$, unless otherwise specified)

FORWARD CURRENT vs. FORWARD VOLTAGE

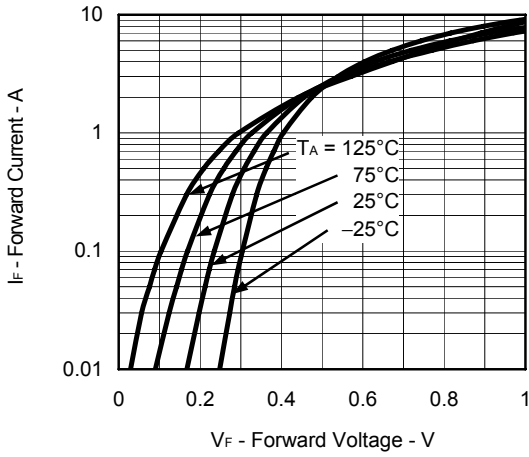

<R> REVERSE CURRENT vs. REVERSE VOLTAGE

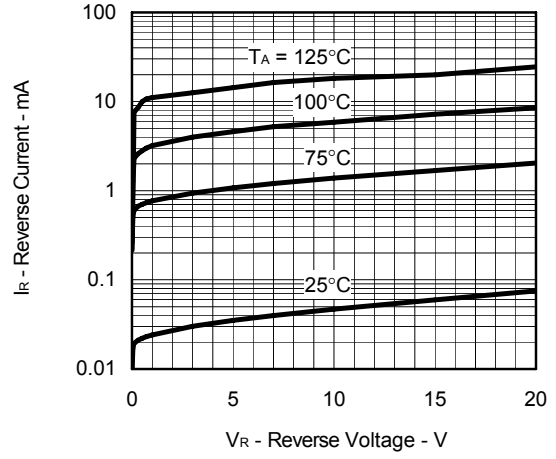

TERMINAL CAPACITANCE vs. REVERSE VOLTAGE

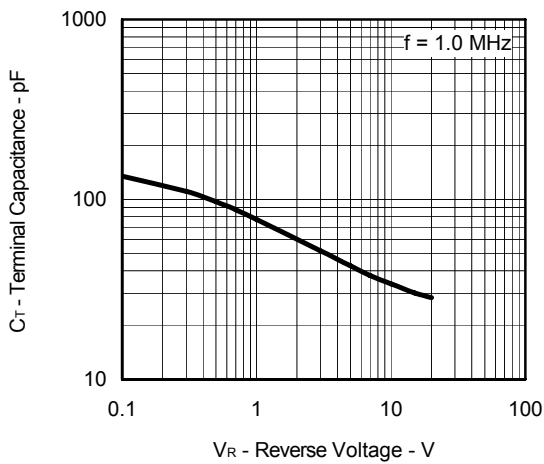

PACKAGE DRAWING (Unit: mm)

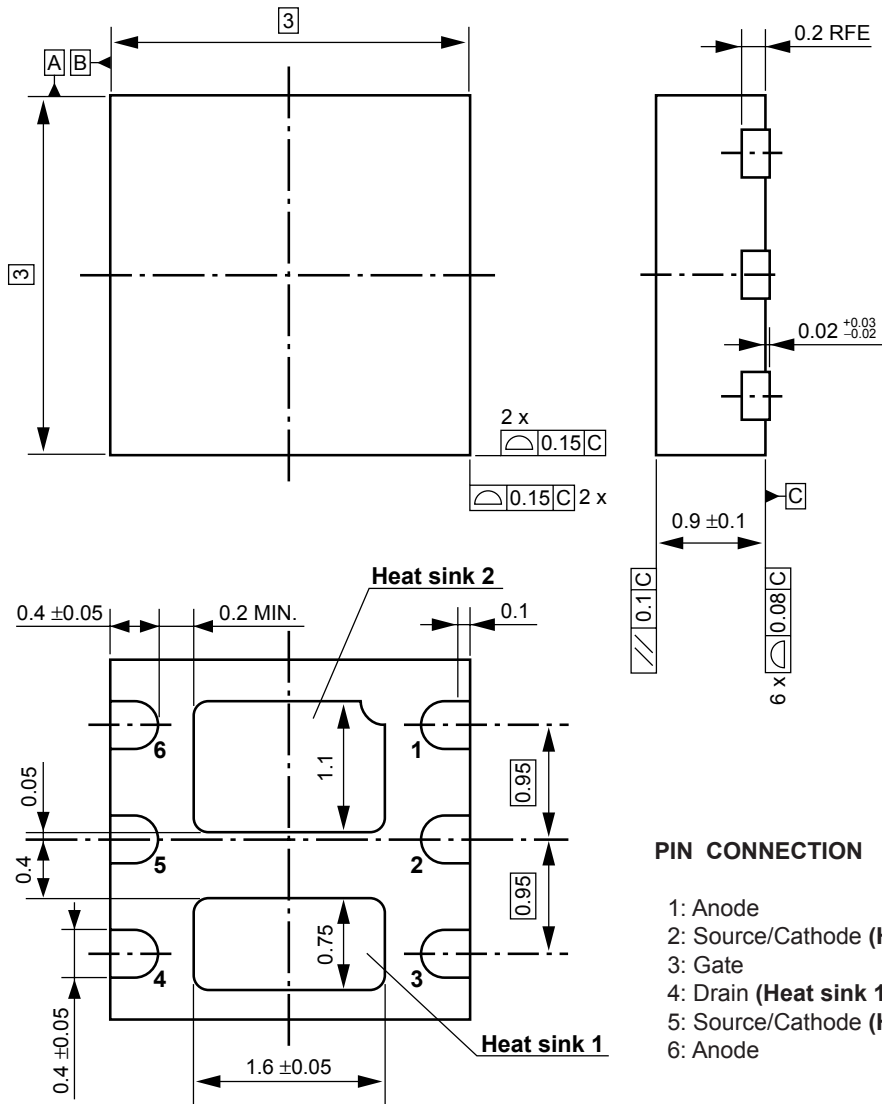

PIN CONNECTION

- 1: Anode
- 2: Source/Cathode (**Heat sink 2**)
- 3: Gate
- 4: Drain (**Heat sink 1**)
- 5: Source/Cathode (**Heat sink 2**)
- 6: Anode

- **The information in this document is current as of May, 2007. The information is subject to change without notice. For actual design-in, refer to the latest publications of NEC Electronics data sheets or data books, etc., for the most up-to-date specifications of NEC Electronics products. Not all products and/or types are available in every country. Please check with an NEC Electronics sales representative for availability and additional information.**
- No part of this document may be copied or reproduced in any form or by any means without the prior written consent of NEC Electronics. NEC Electronics assumes no responsibility for any errors that may appear in this document.
- NEC Electronics does not assume any liability for infringement of patents, copyrights or other intellectual property rights of third parties by or arising from the use of NEC Electronics products listed in this document or any other liability arising from the use of such products. No license, express, implied or otherwise, is granted under any patents, copyrights or other intellectual property rights of NEC Electronics or others.
- Descriptions of circuits, software and other related information in this document are provided for illustrative purposes in semiconductor product operation and application examples. The incorporation of these circuits, software and information in the design of a customer's equipment shall be done under the full responsibility of the customer. NEC Electronics assumes no responsibility for any losses incurred by customers or third parties arising from the use of these circuits, software and information.
- While NEC Electronics endeavors to enhance the quality, reliability and safety of NEC Electronics products, customers agree and acknowledge that the possibility of defects thereof cannot be eliminated entirely. To minimize risks of damage to property or injury (including death) to persons arising from defects in NEC Electronics products, customers must incorporate sufficient safety measures in their design, such as redundancy, fire-containment and anti-failure features.
- NEC Electronics products are classified into the following three quality grades: "Standard", "Special" and "Specific".

The "Specific" quality grade applies only to NEC Electronics products developed based on a customer-designated "quality assurance program" for a specific application. The recommended applications of an NEC Electronics product depend on its quality grade, as indicated below. Customers must check the quality grade of each NEC Electronics product before using it in a particular application.

"Standard": Computers, office equipment, communications equipment, test and measurement equipment, audio and visual equipment, home electronic appliances, machine tools, personal electronic equipment and industrial robots.

"Special": Transportation equipment (automobiles, trains, ships, etc.), traffic control systems, anti-disaster systems, anti-crime systems, safety equipment and medical equipment (not specifically designed for life support).

"Specific": Aircraft, aerospace equipment, submersible repeaters, nuclear reactor control systems, life support systems and medical equipment for life support, etc.

The quality grade of NEC Electronics products is "Standard" unless otherwise expressly specified in NEC Electronics data sheets or data books, etc. If customers wish to use NEC Electronics products in applications not intended by NEC Electronics, they must contact an NEC Electronics sales representative in advance to determine NEC Electronics' willingness to support a given application.

(Note)

- (1) "NEC Electronics" as used in this statement means NEC Electronics Corporation and also includes its majority-owned subsidiaries.
- (2) "NEC Electronics products" means any product developed or manufactured by or for NEC Electronics (as defined above).