

**Features**

- Epitaxial Planar Die Construction
- Complementary PNP Type Available (DZT953)
- Ideally Suited for Automated Assembly Processes
- Ideal for Medium Power Switching or Amplification Applications
- **Lead Free By Design/RoHS Compliant (Note 1)**
- **"Green" Device (Note 2)**

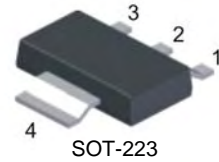

**Mechanical Data**

- Case: SOT-223
- Case Material: Molded Plastic, "Green" Molding Compound. UL Flammability Classification Rating 94V-0
- Moisture Sensitivity: Level 1 per J-STD-020C
- Terminals: Finish — Matte Tin annealed over Copper Leadframe (Lead Free Plating). Solderable per MIL-STD-202, Method 208
- Marking Information: See Page 3
- Ordering Information: See Page 3
- Weight: 0.115 grams (approximate)

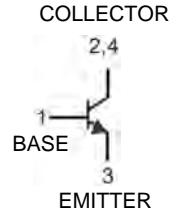
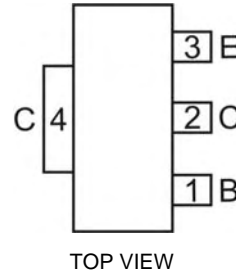

Schematic and Pin Configuration

**Maximum Ratings** @T<sub>A</sub> = 25°C unless otherwise specified

Characteristic	Symbol	Value	Unit
Collector-Base Voltage	V <sub>CBO</sub>	200	V
Collector-Emitter Voltage	V <sub>CEO</sub>	100	V
Emitter-Base Voltage	V <sub>EBO</sub>	6	V
Continuous Collector Current	I <sub>C</sub>	6	A
Power Dissipation	P <sub>tot</sub>	1 (Note 3) 3 (Note 4)	W
Operating and Storage Temperature Range	T <sub>J</sub> , T <sub>STG</sub>	-55 to +150	°C

- Notes:
1. No purposefully added lead.
  2. Diodes Inc.'s "Green" policy can be found on our website at [http://www.diodes.com/products/lead\\_free/index.php](http://www.diodes.com/products/lead_free/index.php).
  3. Device mounted on FR-4 PCB, pad layout as shown on page 4.
  4. The power which can be dissipated, assuming the device is mounted in a typical manner on a PCB with copper equal to 4 square inch minimum.

## Electrical Characteristics @T<sub>A</sub> = 25°C unless otherwise specified

Characteristic	Symbol	Min	Typ	Max	Unit	Test Condition
<b>OFF CHARACTERISTICS</b>						
Collector-Base Breakdown Voltage	V <sub>(BR)CBO</sub>	200	—	—	V	I <sub>C</sub> = 100μA, I <sub>E</sub> = 0
Collector-Emitter Breakdown Voltage	V <sub>(BR)CEO</sub>	100	—	—	V	I <sub>C</sub> = 10mA*, I <sub>B</sub> = 0
Emitter-Base Breakdown Voltage	V <sub>(BR)EBO</sub>	6	—	—	V	I <sub>E</sub> = 100μA, I <sub>C</sub> = 0
Collector Cutoff Current	I <sub>CBO</sub>	—	—	10 1	nA μA	V <sub>CB</sub> = 150V, I <sub>E</sub> = 0 V <sub>CB</sub> = 150V, I <sub>E</sub> = 0, T <sub>A</sub> = 100°C
Emitter Cutoff Current	I <sub>EBO</sub>	—	—	10	nA	V <sub>EB</sub> = 6V, I <sub>C</sub> = 0
<b>ON CHARACTERISTICS</b>						
Collector-Emitter Saturation Voltage	V <sub>CE(SAT)</sub>	— — —	— — —	50 150 340	mV	I <sub>C</sub> = 0.1A, I <sub>B</sub> = 5mA* I <sub>C</sub> = 2A, I <sub>B</sub> = 100mA* I <sub>C</sub> = 5A, I <sub>B</sub> = 500mA*
Base-Emitter Saturation Voltage	V <sub>BE(SAT)</sub>	—	—	1250	mV	I <sub>C</sub> = 5A, I <sub>B</sub> = 500mA*
Base-Emitter Turn-On Voltage	V <sub>BE(ON)</sub>	—	—	1100	mV	I <sub>CE</sub> = 5A, V <sub>CE</sub> = 2V*
DC Current Gain	h <sub>FE</sub>	100 100 50 20	— — — —	— 300 — —	—	I <sub>C</sub> = 10mA, V <sub>CE</sub> = 2V* I <sub>C</sub> = 2A, V <sub>CE</sub> = 2V* I <sub>C</sub> = 4A, V <sub>CE</sub> = 2V* I <sub>C</sub> = 10A, V <sub>CE</sub> = 2V*
<b>SMALL SIGNAL CHARACTERISTICS</b>						
Current Gain-Bandwidth Product	f <sub>T</sub>	—	130	—	MHz	I <sub>C</sub> = 100mA, V <sub>CE</sub> = 10V, f = 50MHz
Output Capacitance	C <sub>obo</sub>	—	35	—	pF	V <sub>CB</sub> = 10V, f = 1MHz
<b>SWITCHING CHARACTERISTICS</b>						
Switching Times	t <sub>on</sub> t <sub>off</sub>	—	50 1650	—	ns ns	I <sub>C</sub> = 1A, V <sub>CC</sub> = 10V I <sub>B1</sub> = I <sub>B2</sub> = 100mA

\* Measured under pulsed conditions. Pulse width = 300μs. Duty cycle ≤2%

## Typical Characteristics @T<sub>amb</sub> = 25°C unless otherwise specified

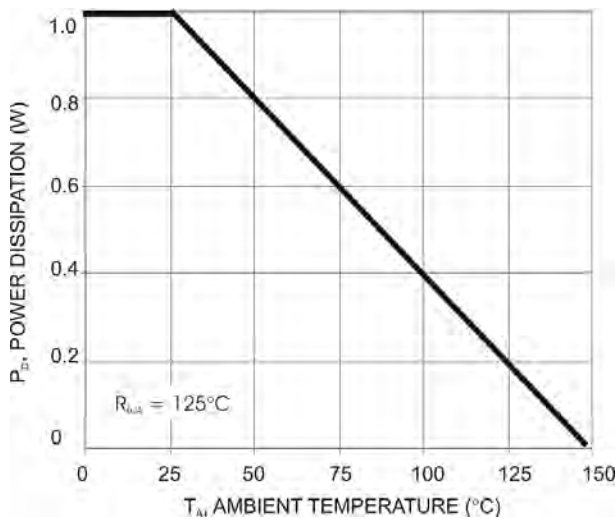

Fig. 1 Power Dissipation vs. Ambient Temperature (Note 3)

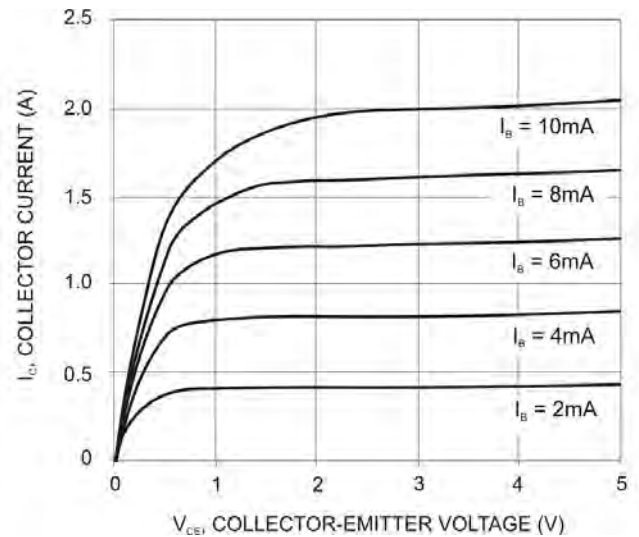

Fig. 2 Collector Current vs. Collector Emitter-Voltage

Notes: 3. Device mounted on FR-4 PCB, pad layout as shown on page 4.

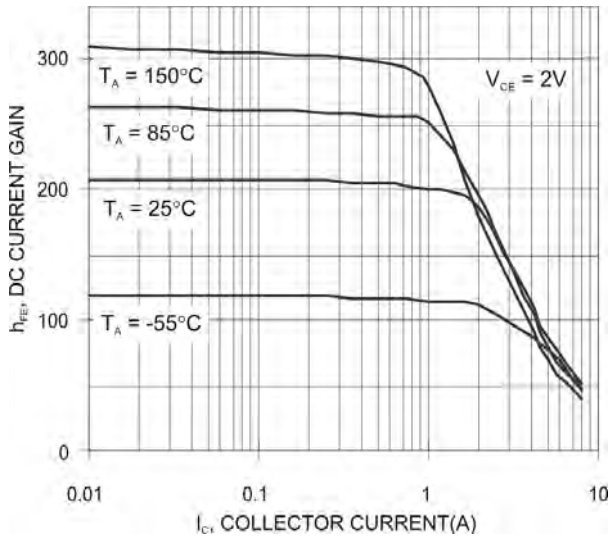

Fig. 3 Typical DC Current Gain vs. Collector Current

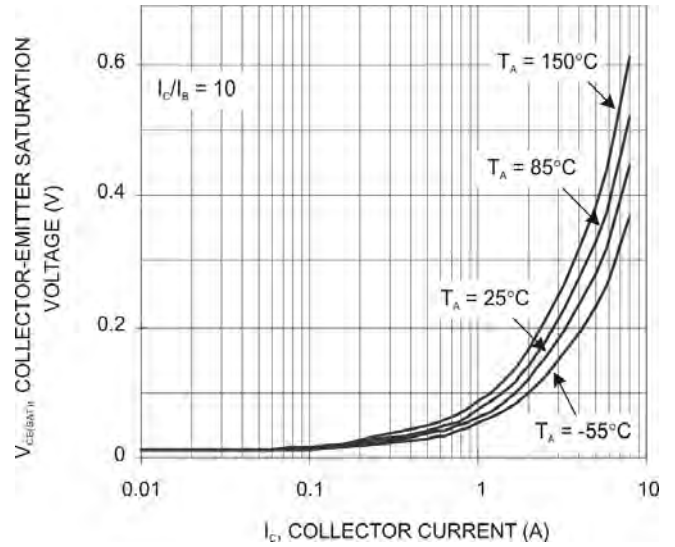

Fig. 4 Collector-Emitter Saturation Voltage vs. Collector Current

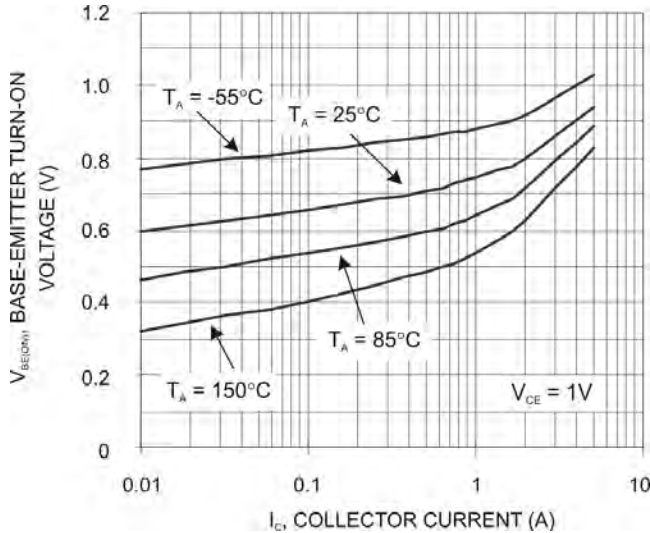

Fig. 5 Base-Emitter Turn-On Voltage vs. Collector Current

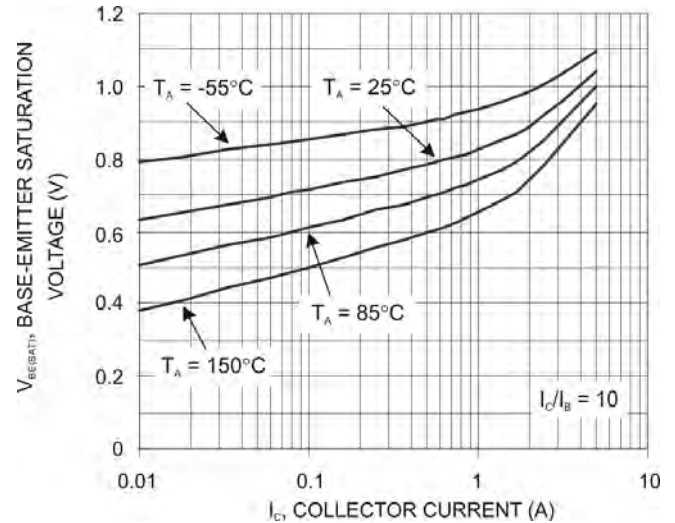

Fig. 6 Base-Emitter Saturation Voltage vs. Collector Current

## Ordering Information (Note 5)

Device	Packaging	Shipping
DZT853-13	SOT-223	2500/Tape & Reel

Notes: 5. Packaging Details as shown on page 4, or go to our website at <http://www.diodes.com/ap2007.pdf>.

## Marking Information

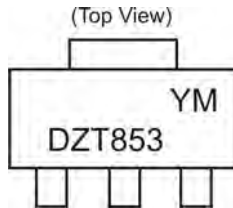

DZT853 = Product Type Marking Code  
 YM = Date Code Marking  
 Y = Year ex: T = 2006  
 M = Month ex: 9 = September

### Date Code Key

Year	2006	2007	2008	2009	2010	2011	2012
Code	T	U	V	W	X	Y	Z

Month	Jan	Feb	Mar	Apr	May	Jun	Jul	Aug	Sep	Oct	Nov	Dec
Code	1	2	3	4	5	6	7	8	9	O	N	D

## Package Outline Dimensions

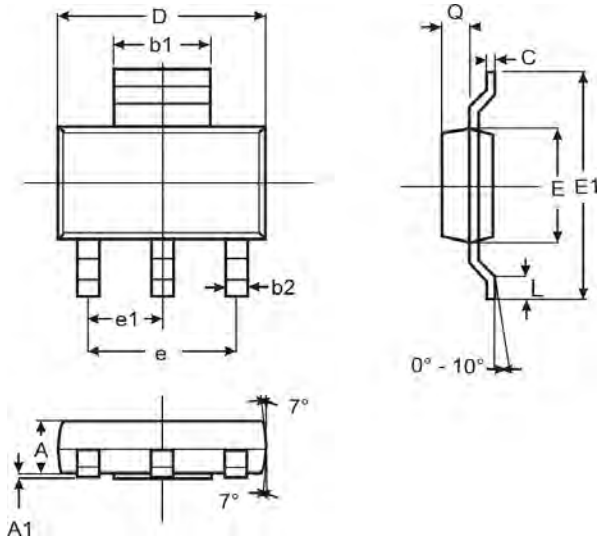

SOT-223			
Dim	Min	Max	Typ
A	1.55	1.65	1.60
A1	0.010	0.15	0.05
b1	2.90	3.10	3.00
b2	0.60	0.80	0.70
C	0.20	0.30	0.25
D	6.45	6.55	6.50
E	3.45	3.55	3.50
E1	6.90	7.10	7.00
e	—	—	4.60
e1	—	—	2.30
L	0.85	1.05	0.95
Q	0.84	0.94	0.89
All Dimensions in mm			

## Suggested Pad Layout: (Based on IPC-SM-782)

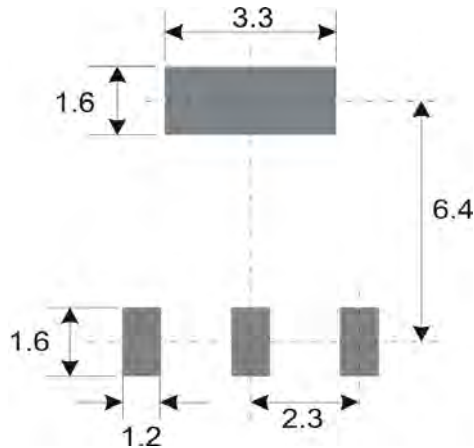

(Unit:mm)

### IMPORTANT NOTICE

Diodes Incorporated and its subsidiaries reserve the right to make modifications, enhancements, improvements, corrections or other changes without further notice to any product herein. Diodes Incorporated does not assume any liability arising out of the application or use of any product described herein; neither does it convey any license under its patent rights, nor the rights of others. The user of products in such applications shall assume all risks of such use and will agree to hold Diodes Incorporated and all the companies whose products are represented on our website, harmless against all damages.

### LIFE SUPPORT

Diodes Incorporated products are not authorized for use as critical components in life support devices or systems without the expressed written approval of the President of Diodes Incorporated.