



NPN Epitaxial Planar Transistor

BTN1053L3

Features

- 5W power dissipation
- Excellent H_{FE} Characteristics up to 1A
- Low Saturation Voltage
 $V_{CE(sat)}=0.15V(\text{typ})(I_C=1A, I_B=50mA)$.
- 5A peak pulse current

Absolute Maximum Ratings (Ta=25°C)

Parameter	Symbol	Limits	Unit
Collector-Base Voltage	VCBO	150	V
Collector-Emitter Voltage	VCEO	75	V
Emitter-Base Voltage	VEBO	5	V
Collector Current(DC)	IC	1.5	A
Collector Current(Pulsed)	ICP	5 (Note)	
Power Dissipation @Tc=25°C	PD	5	W
Junction Temperature	Tj	150	°C
Storage Temperature	Tstg	-55~+150	°C

Note : Single pulse, Pw≤300μs, Duty Cycle≤2%.



Characteristics (Ta=25°C)

Symbol	Min.	Typ.	Max.	Unit	Test Conditions
BV _{CB0}	150	300	-	V	I _C =100μA
BV _{CES}	150	300		V	I _C =100μA
BV _{CEO}	75	100	-	V	I _C =10mA
BV _{EBO}	5	7.7	-	V	I _E =100μA
I _{CB0}	-	0.9	10	nA	V _{CB} =120V
I _{CES}	-	0.9	10	nA	V _{CE} =120V
I _{EBO}	-	0.6	10	nA	V _{EB} =4V
V _{CE(sat) 1} *	-	-	40	mV	I _C =200mA, I _B =20mA
V _{CE(sat) 2} *	-	-	200	mV	I _C =500mA, I _B =20mA
V _{CE(sat) 3} *	-	-	1.2	V	I _C =1A, I _B =10mA
V _{CE(sat) 4} *	-	-	500	mV	I _C =2A, I _B =100mA
V _{BE(sat)} *	-	1.1	1.2	V	I _C =3A, I _B =100mA
V _{BE(on)} *	-	1.1	1.2	V	V _{CE} =2V, I _C =3A
h _{FE 1} *	270	-	-	-	V _{CE} =2V, I _C =10mA
h _{FE 2} *	300	600	1200	-	V _{CE} =2V, I _C =500mA
h _{FE 3} *	120	180-	-	-	V _{CE} =2V, I _C =1A
h _{FE 4} *	10	-	-	-	V _{CE} =2V, I _C =4.5A
f _T	-	140	-	MHz	V _{CE} =10V, I _C =50mA, f=100MHz
C _{ob}	-	20	-	pF	V _{CB} =10V, I _E =0A, f=1MHz

*Pulse Test: Pulse Width ≤300us, Duty Cycle ≤2%



Characteristic Curves

Current Gain vs Collector Current

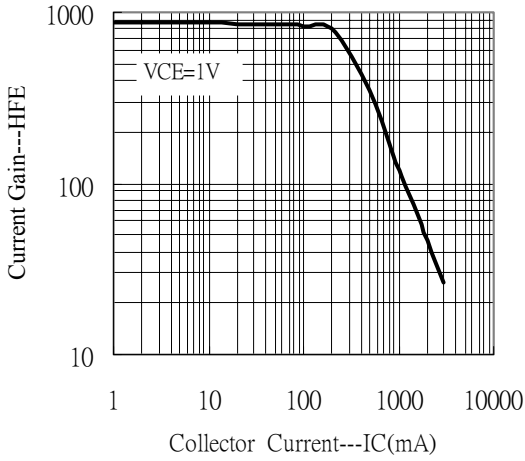

Current Gain vs Collector Current

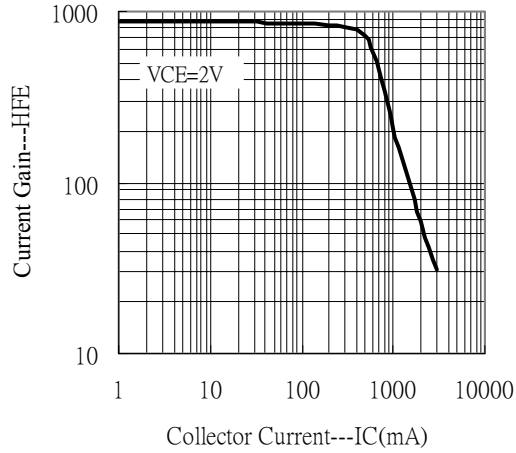

Current Gain vs Collector Current

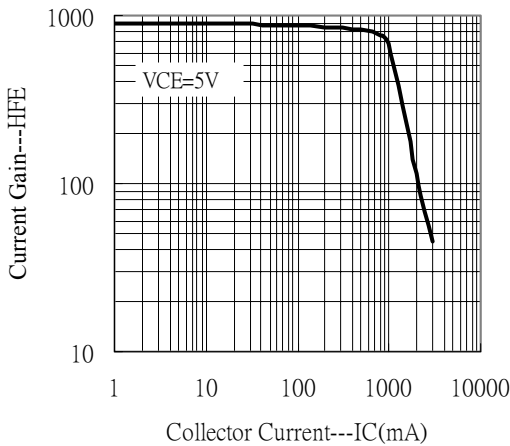

Saturation Voltage vs Collector Current

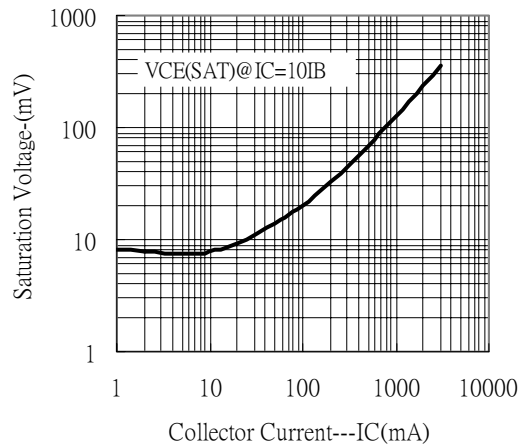

Saturation Voltage vs Collector Current

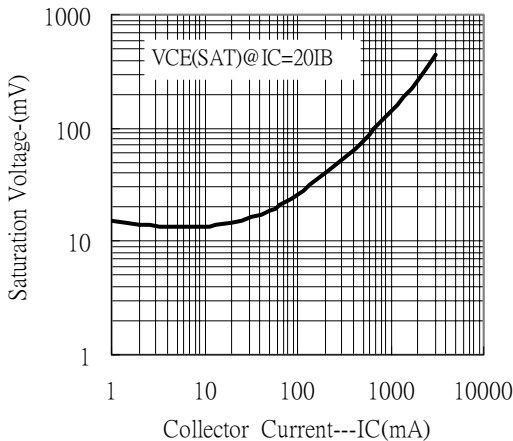

Saturation Voltage vs Collector Current

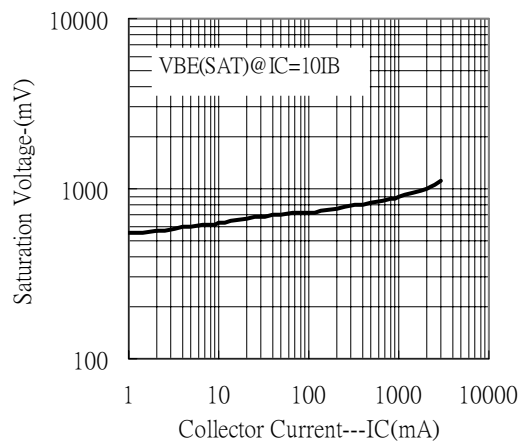



Power Derating Curve

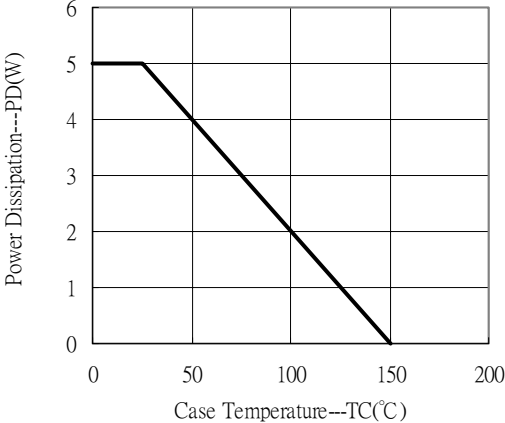

SOT-223 Dimension

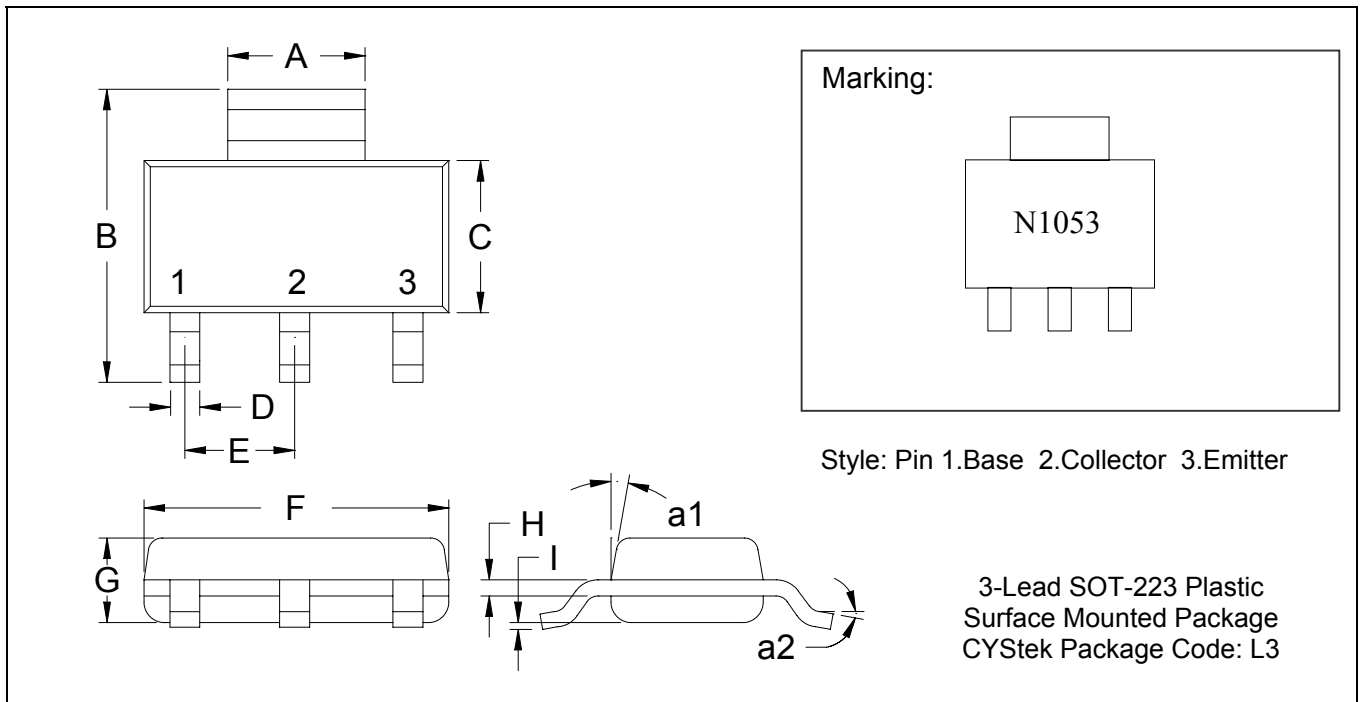

*: Typical

DIM	Inches		Millimeters		DIM	Inches		Millimeters	
	Min.	Max.	Min.	Max.		Min.	Max.	Min.	Max.
A	0.1142	0.1220	2.90	3.10	G	0.0551	0.0709	1.40	1.80
B	0.2638	0.2874	6.70	7.30	H	0.0098	0.0138	0.25	0.35
C	0.1299	0.1457	3.30	3.70	I	0.0008	0.0039	0.02	0.10
D	0.0236	0.0315	0.60	0.80	a1	*13°	-	*13°	-
E	*0.0906	-	*2.30	-	a2	0°	10°	0°	10°
F	0.2480	0.2638	6.30	6.70					

Notes: 1.Controlling dimension: millimeters.
 2.Maximum lead thickness includes lead finish thickness, and minimum lead thickness is the minimum thickness of base material.
 3.If there is any question with packing specification or packing method, please contact your local CYStek sales office.

Material:

- Lead: 42 Alloy; solder plating
- Mold Compound: Epoxy resin family, flammability solid burning class: UL94V-0

Important Notice:

- All rights are reserved. Reproduction in whole or in part is prohibited without the prior written approval of CYStek.
- CYStek reserves the right to make changes to its products without notice.
- CYStek **semiconductor products are not warranted to be suitable for use in Life-Support Applications, or systems.**
- CYStek assumes no liability for any consequence of customer product design, infringement of patents, or application assistance.