

Cree® SMD LED

Model # LP6-EWN1-03-N3

Data Sheet

120-degree, 6.0 x 5.0 mm, SMT LED in white color with water-transparent lens

Applications

- Indicators
- Illuminations
- LCD Back Lights
- Automobile Applications

Absolute Maximum Ratings ($T_A = 25^\circ\text{C}$)

Items	Symbol	Absolute Maximum Rating	Unit
Forward Current	I_F	3 x 50	mA
Peak Forward Current ^{Note 1}	I_{FP}	3 x 100	mA
Reverse Voltage	V_R	5	V
Power Dissipation	P_D	3 x 240	mW
Operation Temperature	T_{opr}	-40 ~ +100	°C
Storage Temperature	T_{stg}	-40 ~ +100	°C
Junction Temperature	T_J	110	°C
Junction/Ambient ^{Note 2}	R_{THJA}	3 x 300	°C/W
Junction/Solder Point	R_{THJS}	3 x 160	°C/W

Notes:

1. Pulse width ≤ 0.1 msec, duty $\leq 1/10$.
2. Rth test condition: mounted on PCB FR4 (pad size ≥ 40 mm²)

Typical Electrical & Optical Characteristics ($T_A = 25^\circ\text{C}$)

Characteristics	Symbol	Condition	Unit	Minimum	Typical	Maximum
Forward Voltage	V_F	$I_F = 3 \times 50$ mA	V		3.8	4.8
Reverse Current	I_R	$V_R = 5$ V	μA			10
Luminous Intensity	I_V	$I_F = 3 \times 50$ mA	mcd	7100	10000	
Luminous Flux	Φ_V	$I_F = 3 \times 50$ mA	mlm		27000	
Chromaticity Coordinates	x	$I_F = 3 \times 50$ mA			0.31	
	y	$I_F = 3 \times 50$ mA			0.32	
50% Power Angle	$2\theta_{1/2}$	$I_F = 3 \times 50$ mA	deg		120	

Standard Bins for LP6-EWN1-03-N3 ($I_f = 3 \times 50 \text{ mA}$)

Lamps are sorted to luminous intensity (I_v) and chromaticity coordinates (x,y) bins shown.

Orders for LP6-EWN1-03-N3 may be filled with any or all bins contained as below.

All luminous intensity (I_v) and chromaticity coordinates (x,y) values shown and specified are at $I_f = 3 \times 50 \text{ mA}$.

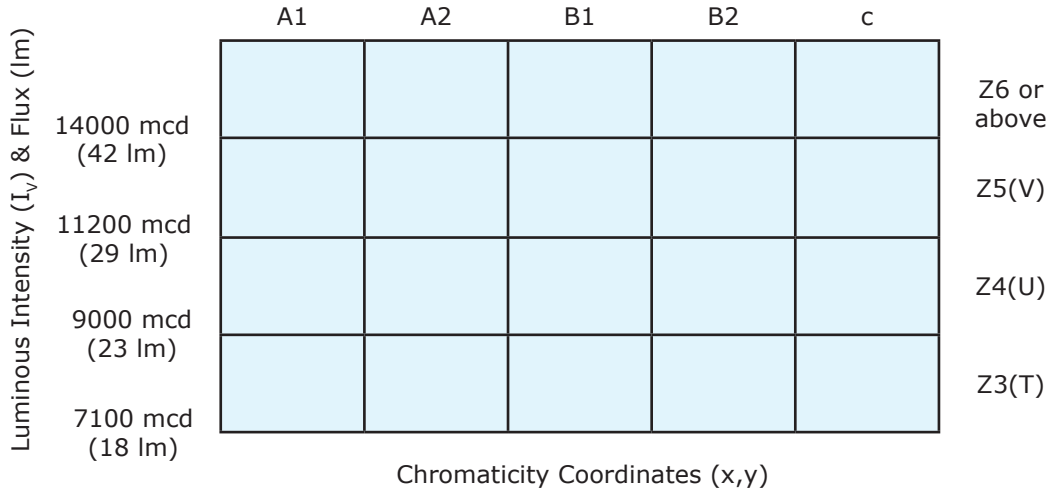

Rank		A1				A2				B1			
Chromaticity Coordinates	x	0.245	0.264	0.280	0.264	0.264	0.283	0.296	0.280	0.283	0.307	0.313	0.296
	y	0.229	0.267	0.248	0.220	0.267	0.305	0.276	0.248	0.305	0.337	0.297	0.276

Rank		B2				c			
Chromaticity Coordinates	x	0.307	0.330	0.330	0.313	0.330	0.361	0.356	0.330
	y	0.337	0.360	0.318	0.297	0.360	0.385	0.351	0.318

Important Notes:

1. All ranks will be included per delivery; rank ratio will be based on the dice distribution.
2. Tolerance of measurement of luminous intensity is $\pm 10\%$.
3. Tolerance of measurement of the color coordinates is ± 0.01 .
4. Tolerance of measurement of V_f is $\pm 0.05 \text{ V}$.
5. Packaging methods are available for selection; please refer to the "Cree LED Lamp Packaging" document.
6. Please refer to the "Cree LED Lamp Reliability Test Standards" document for reliability test conditions.
7. Please refer to the "Cree LED Lamp Soldering & Handling" document for information about how to use this LED product safely.
8. Do not handle the device by the SMD surface. Care must be taken to avoid damage to the SMD surface or the interior of the device, which can be damaged by excessive force to the SMD surface.

CIE Chromaticity Diagram

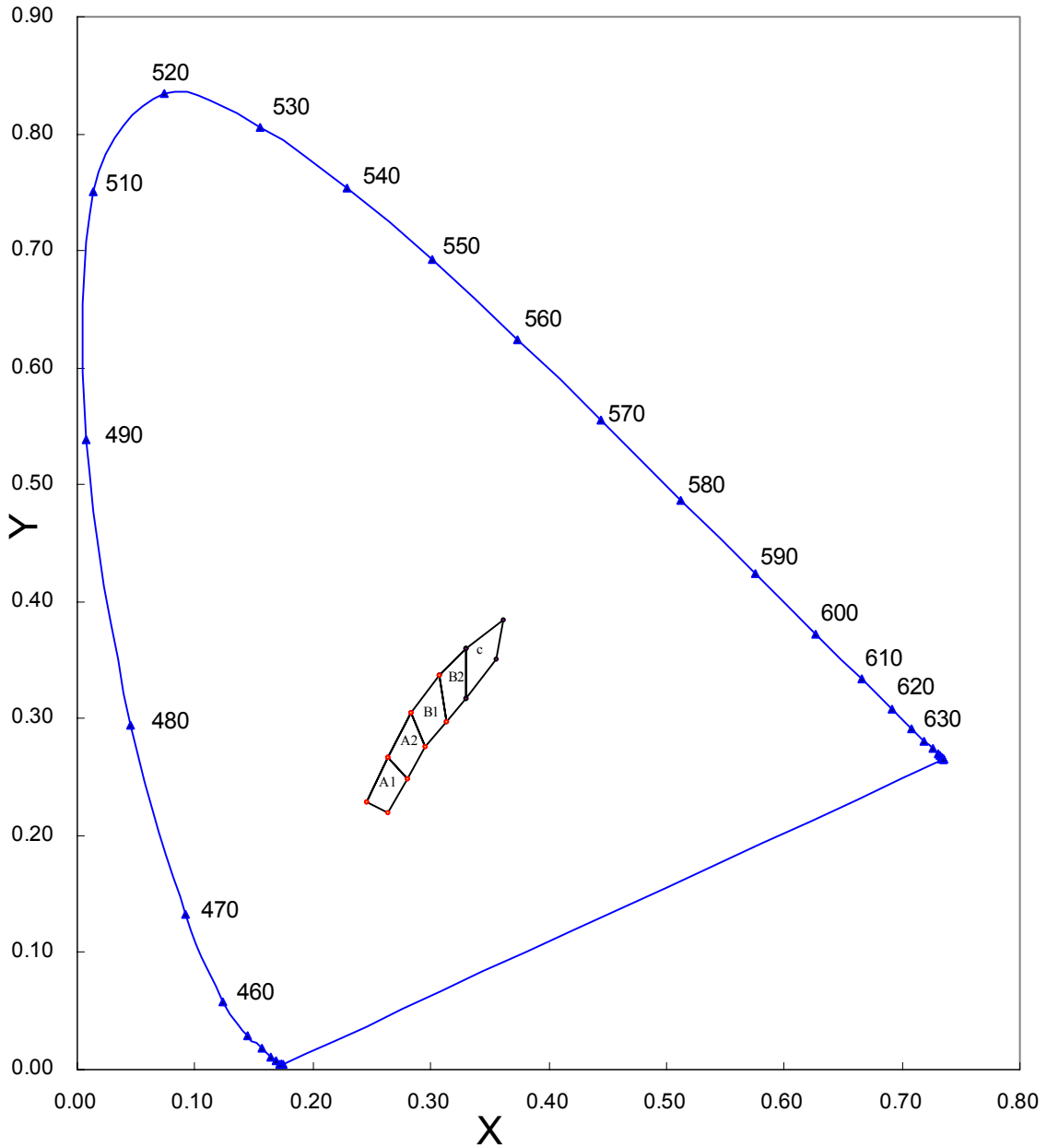

Graphs

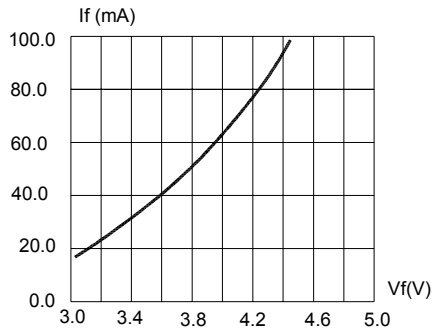

FIG.1 FORWARD CURRENT VS. FORWARD VOLTAGE.

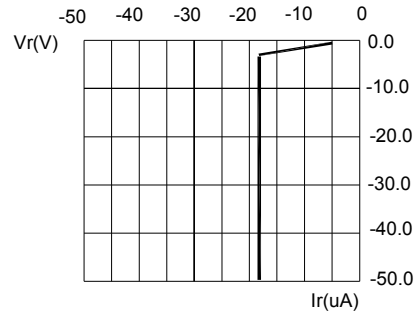

FIG.2 REVERSE CURRENT VS. REVERSE VOLTAGE.

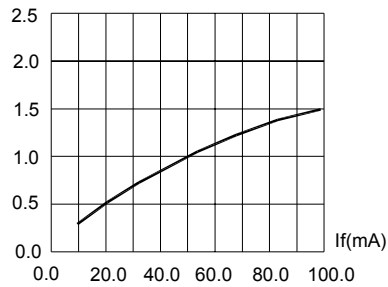

FIG.3 RELATIVE LUMINOUS INTENSITY VS. FORWARD CURRENT

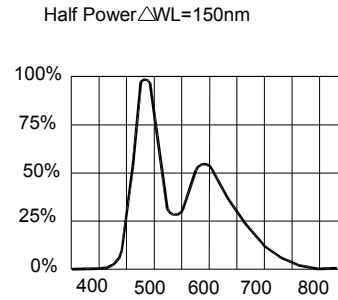

FIG.4 RELATIVE LUMINOUS INTENSITY VS. WAVELENGTH.

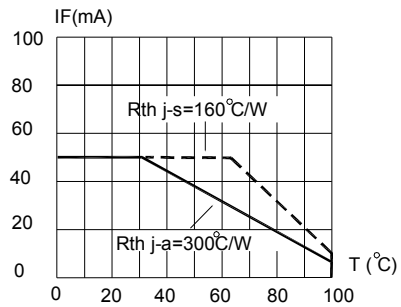

FIG.5 MAXIMUM FORWARD DC CURRENT VS TEMPERATURE. DERATING BASED ON Tjmax=110 °C

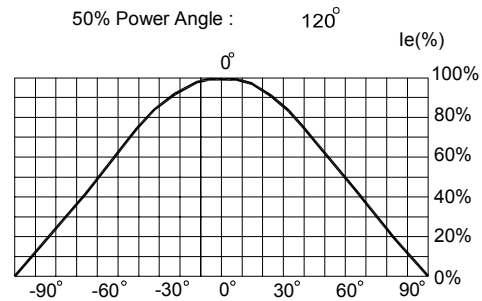
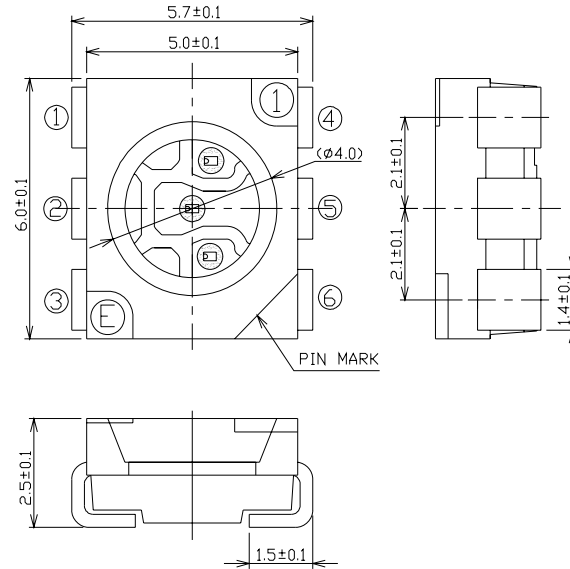

FIG.6 FAR FIELD PATTERN

Mechanical Dimensions

All dimensions are in mm.



PIN CONNECTIONS

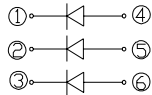

① ② ③ CATHODE
④ ⑤ ⑥ ANODE

Unit: mm

Notes

RoHS Compliance

The levels of environmentally sensitive, persistent biologically toxic (PBT), persistent organic pollutants (POP), or otherwise restricted materials in this product are below the maximum concentration values (also referred to as the threshold limits) permitted for such substances, or are used in an exempted application, in accordance with EU Directive 2002/95/EC on the restriction of the use of certain hazardous substances in electrical and electronic equipment (RoHS), as amended through April 21, 2006.

Vision Advisory Claim

Users should be cautioned not to stare at the light of this LED product. The bright light can damage the eye.

Kit Number System

Cree LED lamps are tested and sorted into performance bins. A bin is specified by ranges of color, forward voltage, and brightness. Sorted LEDs are packaged for shipping in various convenient options. Please refer to the "Cree LED Lamp Packaging Standard" document for more information about shipping and packaging options.

Cree LEDs are sold by order codes in combinations of bins called kits. Order codes are configured in the following manner:

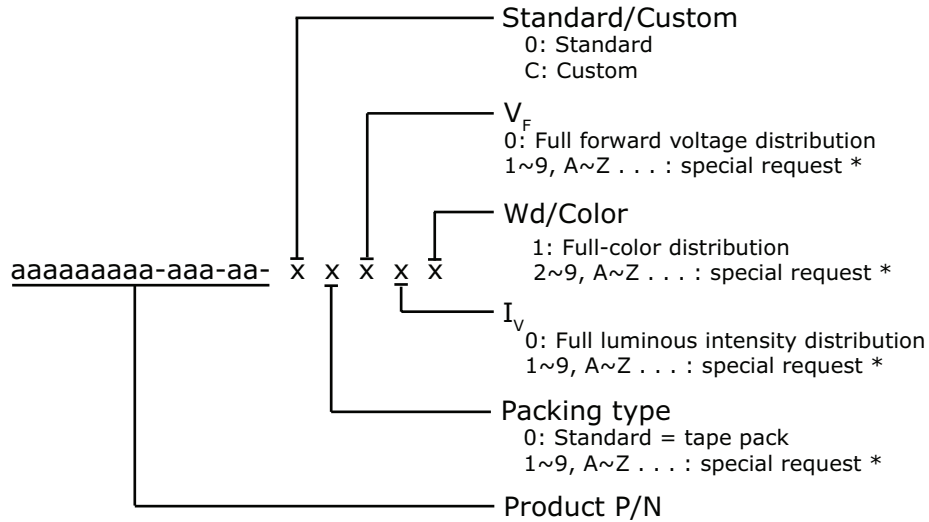

* Contact your Cree sales representative for ordering information.

Standard Available Kits*

Kit Number	Description
LP6-EWN1-03-N3-00001	SMD 120 White, FULL RANK, Tape & Reel
LP6-EWN1-03-N3-00002	SMD 120 White, A1, A2, B1, B2, Tape & Reel

* Please contact your Cree representative about the availability of non-standard kits.