

NCP1410

250 mA Sync-Rect PFM Step-Up DC-DC Converter with Low-Battery Detector

NCP1410 is a monolithic micropower high frequency Boost (step-up) voltage switching converter IC specially designed for battery operated hand-held electronic products up to 250 mA loading. It integrates Synchronous Rectifier for improving efficiency as well as eliminating the external Schottky Diode. High switching frequency (up to 600 kHz) allows low profile inductor and output capacitor being used. Low-Battery Detector, Logic-Controlled Shutdown and Cycle-by-Cycle Current Limit provide value-added features for various battery-operated applications. With all these functions ON, the device quiescent supply current is only 9.0 μ A typical. This device is available in space saving compact Micro8™ package.

Features

- High Efficiency up to 92%
- Very Low Device Quiescent Supply Current of 9.0 μ A Typical
- Allows use of Small Size Inductor and Capacitor
- Built-in Synchronous Rectifier (PFET) Eliminates One External Schottky Diode
- High Switching Frequency (up to 600 kHz) Allows Use of Small Size Inductor and Capacitor
- High Accuracy Reference Output, 1.19 V \pm 0.6% @ 25°C, can supply more than 2.5 mA when $V_{OUT} \geq 3.3$ V
- 1.0 V Startup at No Load Guaranteed
- Output Voltage from 1.5 V to 5.5 V Adjustable
- Output Current up to 250 mA @ $V_{in} = 2.5$ V, $V_{out} = 3.3$ V
- Logic-Controlled Shutdown
- Open Drain Low-Battery Detector Output
- 1.0 A Cycle-by-Cycle Current Limit
- Low Profile and Minimum External Parts
- Compact Micro8 Package
- Pb-Free Package is Available

Typical Applications

- Personal Digital Assistant (PDA)
- Handheld Digital Audio Product
- Camcorders and Digital Still Camera
- Hand-held Instrument
- Conversion from One or Two NiMH or NiCd, or One Li-ion Cell to 3.3 V/5.0 V



ON Semiconductor®

<http://onsemi.com>

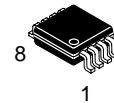

Micro8™
DM SUFFIX
CASE 846A

MARKING DIAGRAM

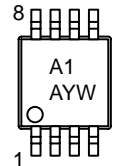

A1 = Device Marking
A = Assembly Location
Y = Year
W = Work Week

PIN CONNECTIONS

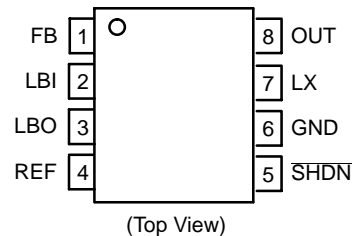

ORDERING INFORMATION

| Device | Package | Shipping† |
|--------------|------------------|------------------|
| NCP1410DMR2 | Micro8 | 4000 Tape & Reel |
| NCP1410DMR2G | Micro8 (Pb-Free) | 4000 Tape & Reel |

†For information on tape and reel specifications, including part orientation and tape sizes, please refer to our Tape and Reel Packaging Specifications Brochure, BRD8011/D.

NCP1410

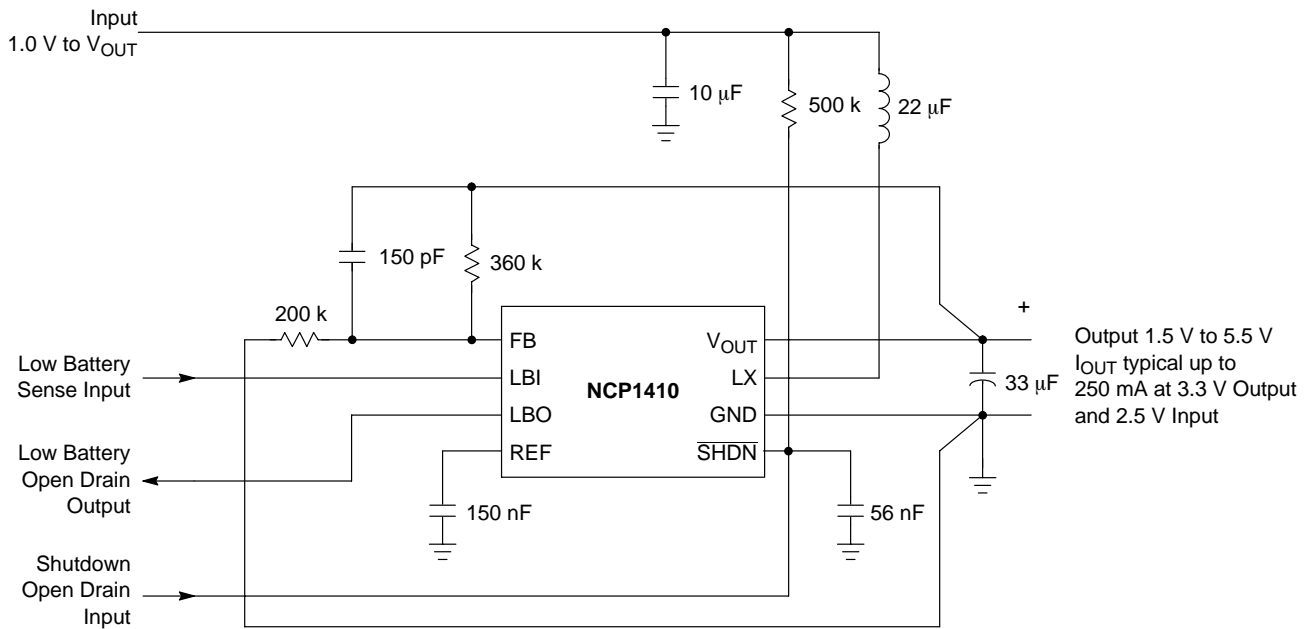

Figure 1. Typical Operating Circuit

MAXIMUM RATINGS (Note 1)

| Rating | Symbol | Value | Unit |
|--|--------------------------|-------------|--------------------------|
| Device Power Supply (Pin 8) | V_{OUT} | -0.3 to 6.0 | V |
| Input/Output Pins (Pin 1–5, Pin 7) | V_{IO} | -0.3 to 6.0 | V |
| Thermal Characteristics – Micro8 Plastic Package Maximum Power Dissipation @ $T_A = 25^\circ\text{C}$ Thermal Resistance Junction to Air | P_D $R_{\theta JA}$ | 520 240 | mW $^\circ\text{C/W}$ |
| Operating Junction Temperature Range | T_J | -40 to +150 | $^\circ\text{C}$ |
| Operating Ambient Temperature Range | T_A | -40 to +85 | $^\circ\text{C}$ |
| Storage Temperature Range | T_{stg} | -55 to +150 | $^\circ\text{C}$ |

Maximum ratings are those values beyond which device damage can occur. Maximum ratings applied to the device are individual stress limit values (not normal operating conditions) and are not valid simultaneously. If these limits are exceeded, device functional operation is not implied, damage may occur and reliability may be affected.

- This device series contains ESD protection and exceeds the following tests:
Human Body Model (HBM) ± 2.0 kV per JEDEC standard: JESD22-A114.
Machine Model Method (MM) ± 200 V per JEDEC standard: JESD22-A115.
- The maximum package power dissipation limit must not be exceeded.

$$P_D = \frac{T_{J(\max)} - T_A}{R_{\theta JA}}$$

- Latchup Current Maximum Rating: ± 150 mA per JEDEC standard: JESD78.
- Moisture Sensitivity Level: MSL 1 per IPC/JEDEC standard: J-STD-020A.

NCP1410

ELECTRICAL CHARACTERISTICS ($V_{OUT} = 3.3\text{ V}$, $T_A = 25^\circ\text{C}$ for typical value, $-40^\circ\text{C} \leq T_A \leq 85^\circ\text{C}$ for min/max values unless otherwise noted.)

| Characteristics | Symbol | Min | Typ | Max | Unit |
|---|---------------------------------|----------|-------|-------|----------------------------|
| Operating Voltage | V_{IN} | 1.0 | – | 5.5 | V |
| Output Voltage Range (Adjusted by external feedback) | V_{OUT} | V_{IN} | – | 5.5 | V |
| Reference Voltage ($C_{REF} = 150\text{ nF}$, under no loading, $T_A = 25^\circ\text{C}$) | V_{REF_NL} | 1.183 | 1.190 | 1.197 | V |
| Reference Voltage ($C_{REF} = 150\text{ nF}$, under no loading, $-40^\circ\text{C} \leq T_A \leq 85^\circ\text{C}$) | $V_{REF_NL_A}$ | 1.178 | – | 1.202 | V |
| Reference Voltage Temperature Coefficient | TC_{VREF} | – | 0.03 | – | $\text{mV}/^\circ\text{C}$ |
| Reference Voltage Load Current ($V_{OUT} = 3.3\text{ V}$, $V_{REF} = V_{REF_NL} \pm 1.5\%$, $C_{REF} = 1.0\text{ }\mu\text{F}$) (Note 5) | I_{REF} | 2.5 | – | – | mA |
| Reference Voltage Load Regulation ($V_{OUT} = 3.3\text{ V}$, $I_{REF} = 0$ to $100\text{ }\mu\text{A}$, $C_{REF} = 1.0\text{ }\mu\text{F}$) | V_{REF_LOAD} | – | 0.015 | 1.0 | mV |
| Reference Voltage Line Regulation (V_{OUT} from 1.5 V to 5.5 V , $C_{REF} = 1.0\text{ }\mu\text{F}$) | V_{REF_LINE} | – | 0.03 | 1.0 | mV/V |
| FB, LBI Input Threshold ($I_{LOAD} = 0\text{ mA}$) | V_{FB} , V_{LBI} | 1.174 | 1.190 | 1.200 | V |
| N-FET ON Resistance | $R_{DS(ON)-N}$ | | 0.6 | | Ω |
| P-FET ON Resistance | $R_{DS(ON)-P}$ | | 0.9 | | Ω |
| LX Switch Current Limit (NFET) | I_{LIM} | – | 1.0 | – | A |
| Operating Current into OUT ($V_{FB} = 1.4\text{ V}$, i.e. No switching, $V_{OUT} = 3.3\text{ V}$) | I_Q | – | 9.0 | 14 | μA |
| Shutdown Current into OUT ($\overline{\text{SHDN}} = \text{GND}$) | I_{SD} | – | 0.05 | 1.0 | μA |
| LX Switch MAX. ON-Time ($V_{FB} = 1.0\text{ V}$, $V_{OUT} = 3.3\text{ V}$) | t_{ON} | 1.2 | 1.4 | 1.8 | μs |
| LX Switch MIN. OFF-Time ($V_{FB} = 1.0\text{ V}$, $V_{OUT} = 3.3\text{ V}$) | t_{OFF} | 0.25 | 0.31 | 0.37 | μs |
| FB Input Current | I_{FB} | – | 1.5 | 9.0 | nA |
| LBI Input Current | I_{LBI} | – | 1.5 | 8.0 | nA |
| LBO Low Output Voltage ($V_{LBI} = 0$, $I_{SINK} = 1.0\text{ mA}$) | V_{LBO_L} | – | – | 0.05 | V |
| $\overline{\text{SHDN}}$ Input Current | $I_{\overline{\text{SHDN}}}$ | – | 1.5 | 8.0 | nA |
| $\overline{\text{SHDN}}$ Input Threshold, Low | $V_{\overline{\text{SHDN}}_L}$ | – | – | 0.3 | V |
| $\overline{\text{SHDN}}$ Input Threshold, High | $V_{\overline{\text{SHDN}}_H}$ | 0.6 | – | – | V |

5. Loading capability increases with V_{OUT} .

PIN FUNCTION DESCRIPTIONS

| Pin # | Symbol | Pin Description |
|-------|--------------------------|---|
| 1 | FB | Output Voltage Feedback Input. |
| 2 | LBI | Low-Battery Detector Input. |
| 3 | LBO | Open-Drain Low-Battery Detector Output. Output is LOW when V_{LBI} is $< 1.178\text{ V}$. LBO is high impedance during shutdown. |
| 4 | REF | 1.190 V Reference Voltage Output, bypass with 150 nF capacitor if this pin is not loaded, bypass with 1.0 μF if this pin is loaded up to 2.5 mA @ $V_{OUT} = 3.3\text{ V}$. |
| 5 | $\overline{\text{SHDN}}$ | Shutdown Input. HIGH ($> 0.6\text{ V}$) = operating; LOW ($< 0.3\text{ V}$) = shutdown. |
| 6 | GND | Ground. |
| 7 | LX | N-Channel and P-Channel Power MOSFET Drain Connection. |
| 8 | OUT | Power Output. OUT provides bootstrap power to the IC. |

NCP1410

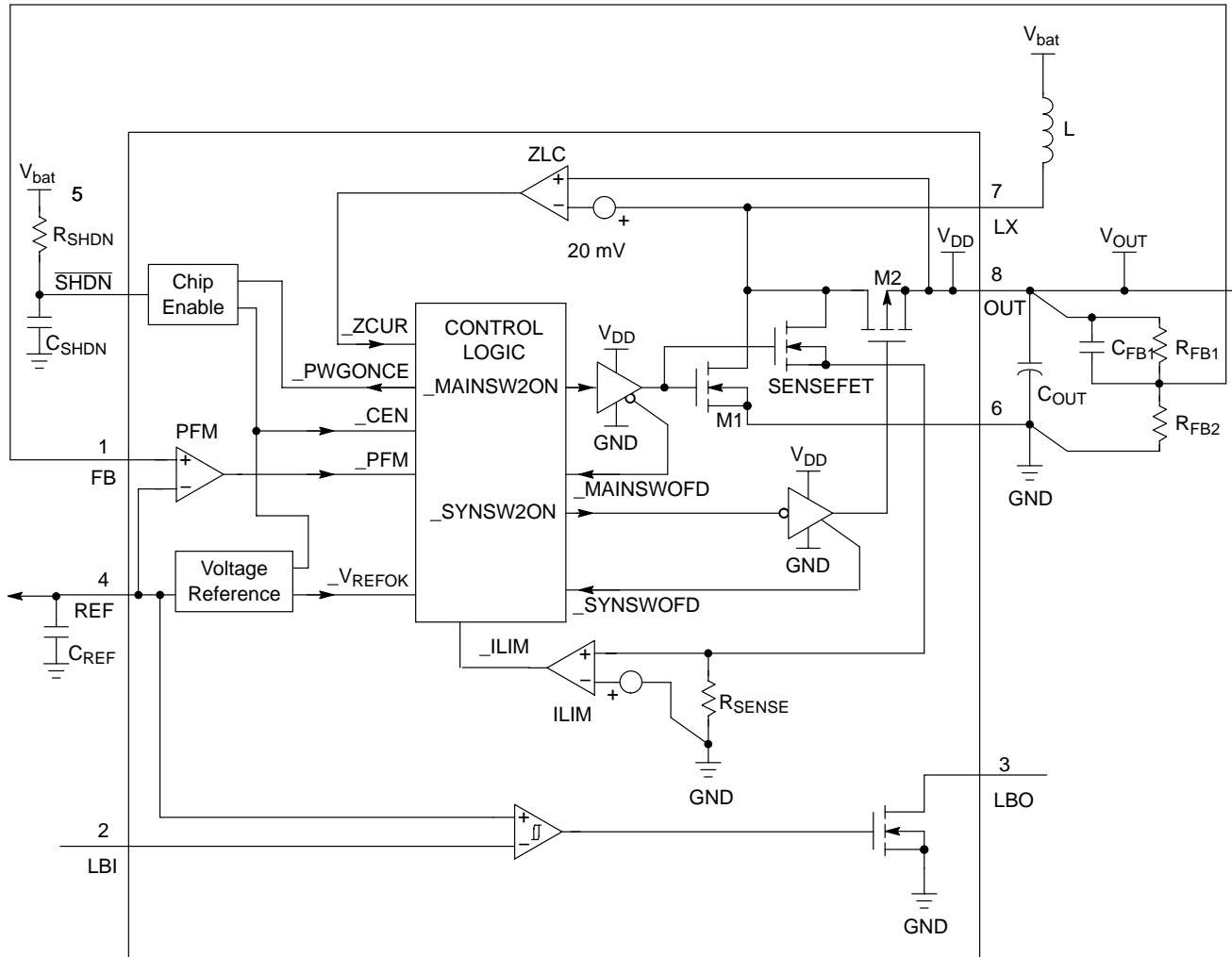

Figure 2. Simplified Functional Diagram

TYPICAL OPERATING CHARACTERISTICS

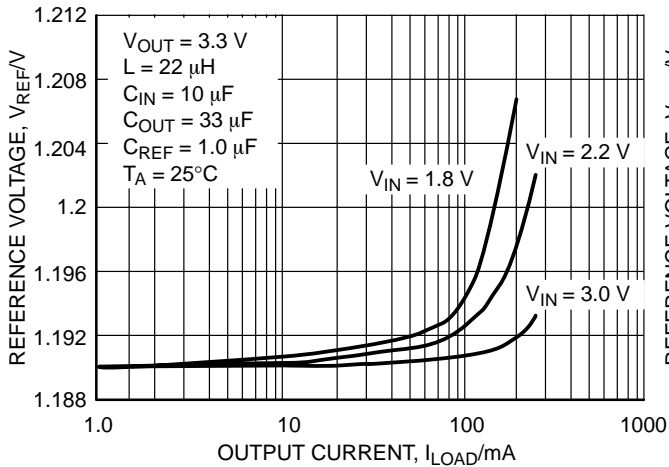

Figure 3. Reference Voltage vs. Output Current

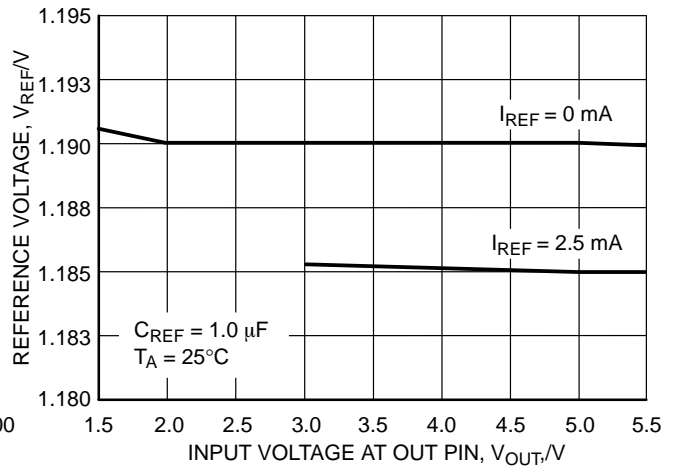

Figure 4. Reference Voltage vs. Input Voltage at OUT pin

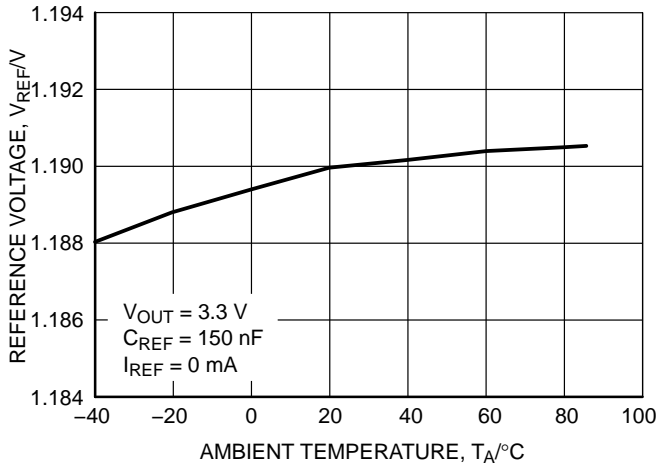

Figure 5. Reference Voltage vs. Temperature

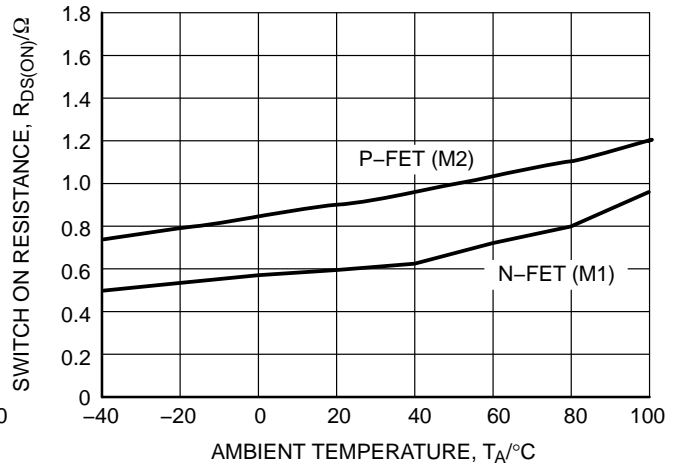

Figure 6. Switch ON Resistance vs. Temperature

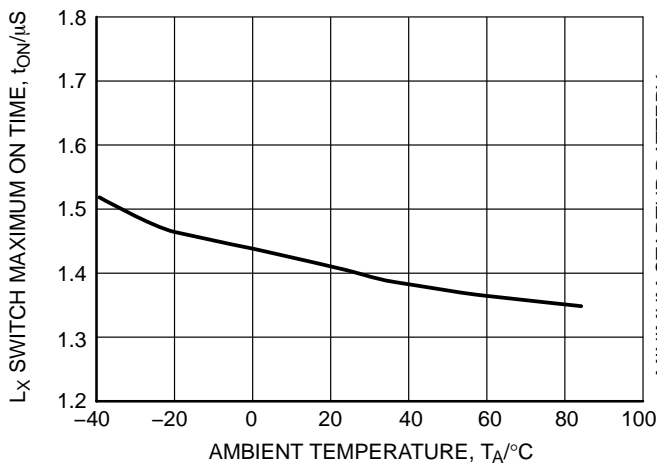

Figure 7. L_X Switch Maximum ON Time vs. Temperature

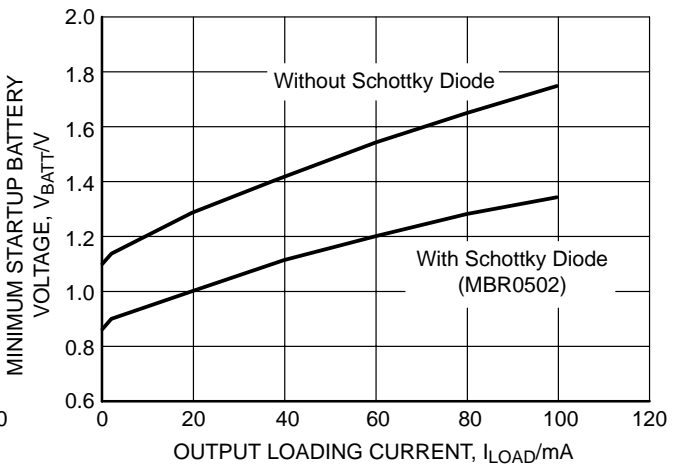

Figure 8. Minimum Startup Battery Voltage vs. Loading Current

TYPICAL OPERATING CHARACTERISTICS

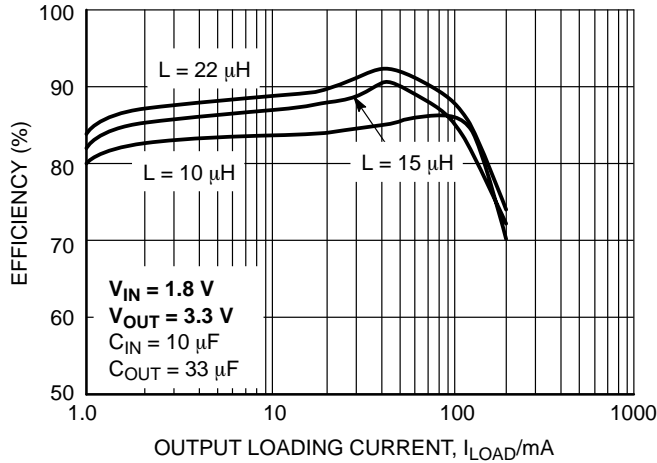

Figure 9. Efficiency vs. Load Current

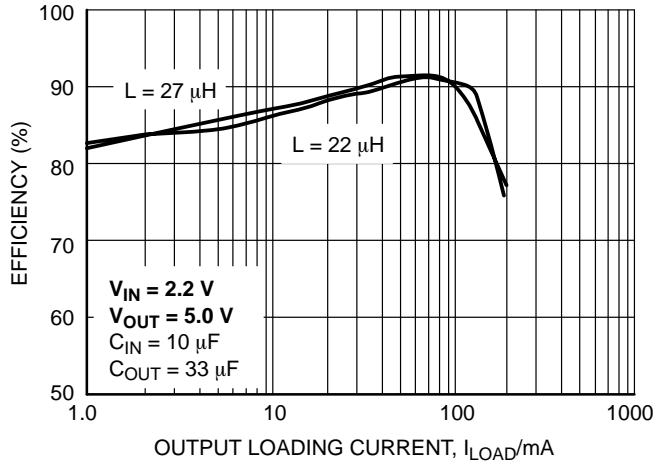

Figure 10. Efficiency vs. Load Current

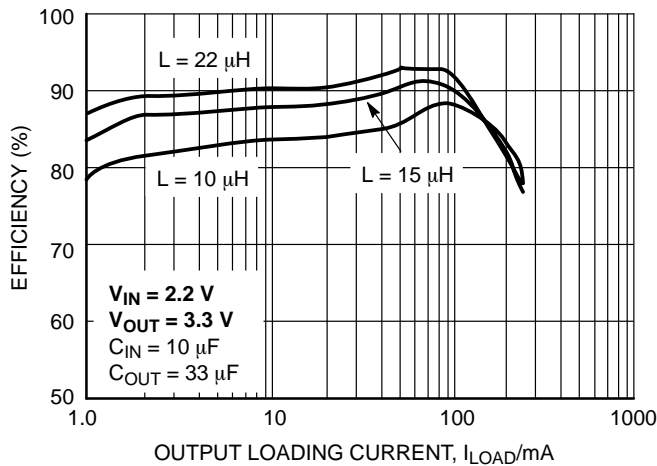

Figure 11. Efficiency vs. Load Current

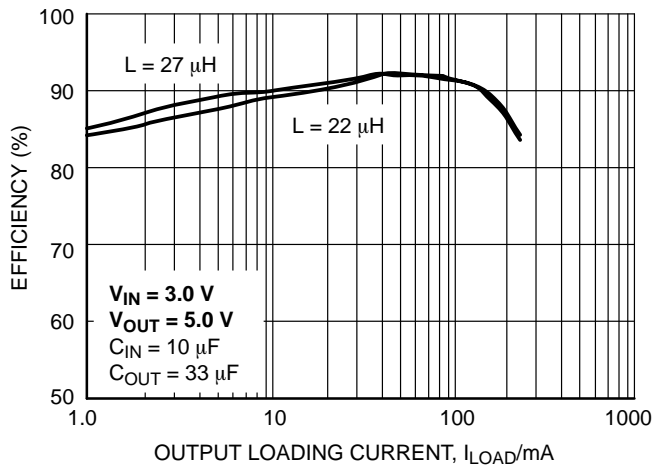

Figure 12. Efficiency vs. Load Current

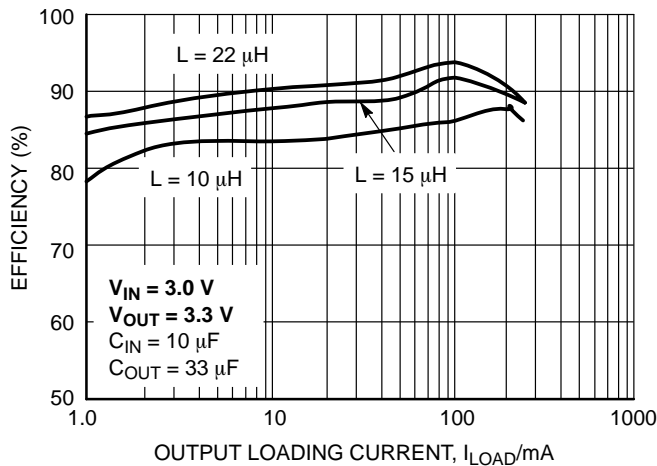

Figure 13. Efficiency vs. Load Current

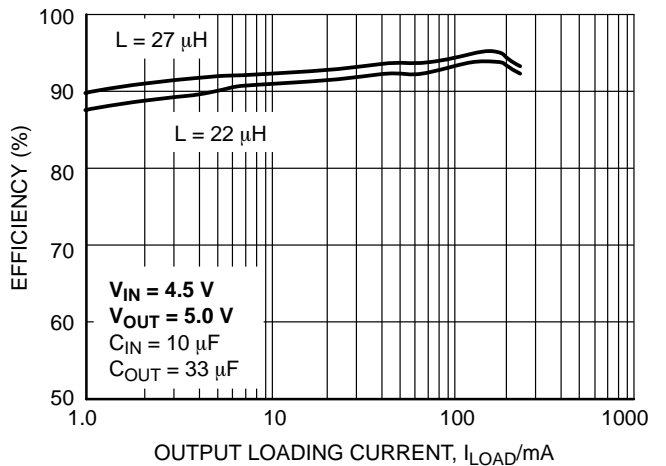

Figure 14. Efficiency vs. Load Current

TYPICAL OPERATING CHARACTERISTICS

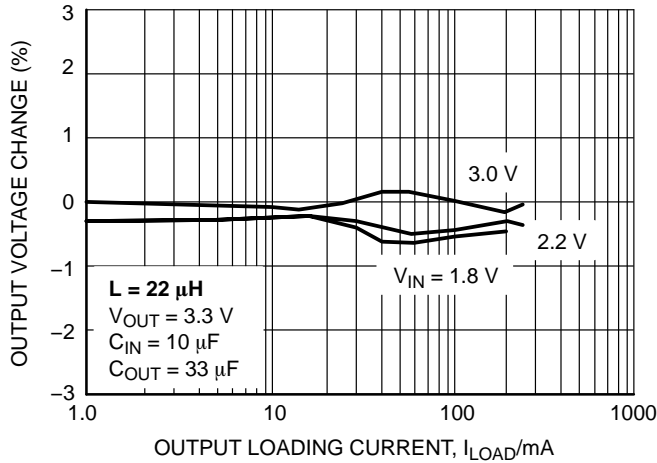

Figure 15. Output Voltage Change vs. Load Current

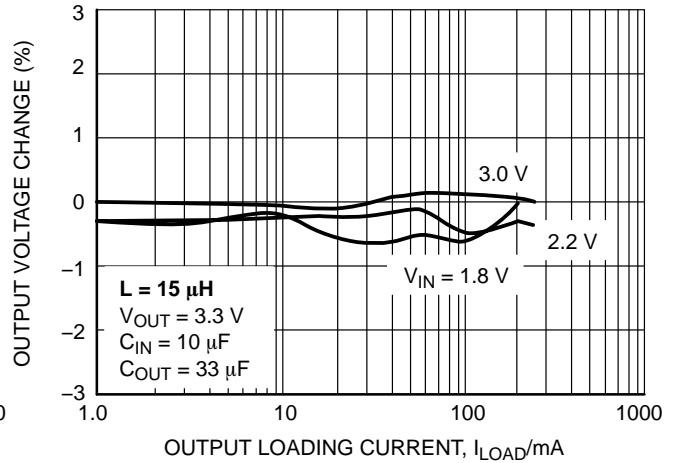

Figure 16. Output Voltage Change vs. Load Current

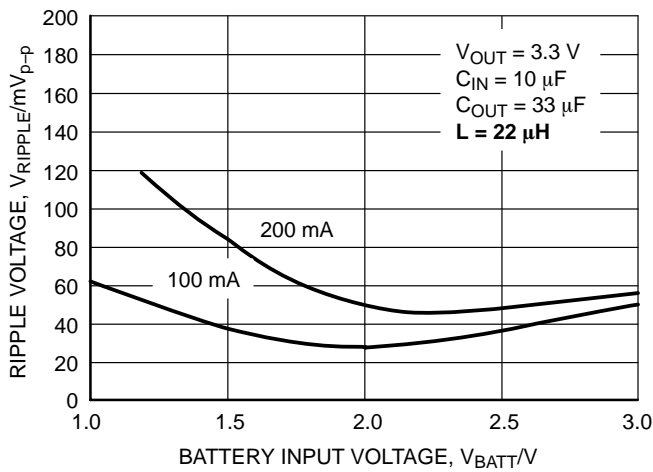

Figure 17. Output Ripple Voltage vs. Battery Input Voltage

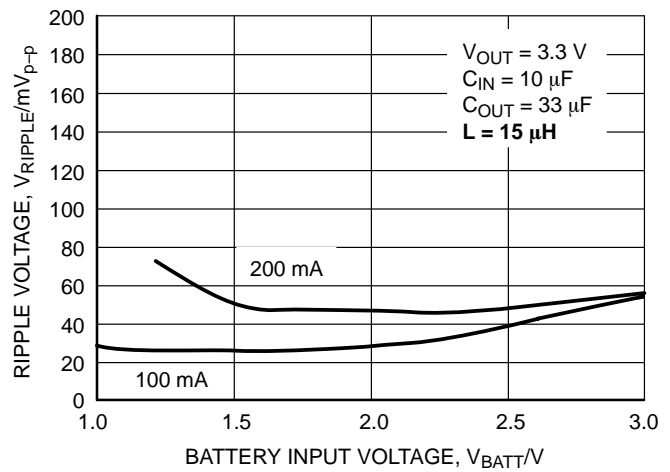

Figure 18. Output Ripple Voltage vs. Battery Input Voltage

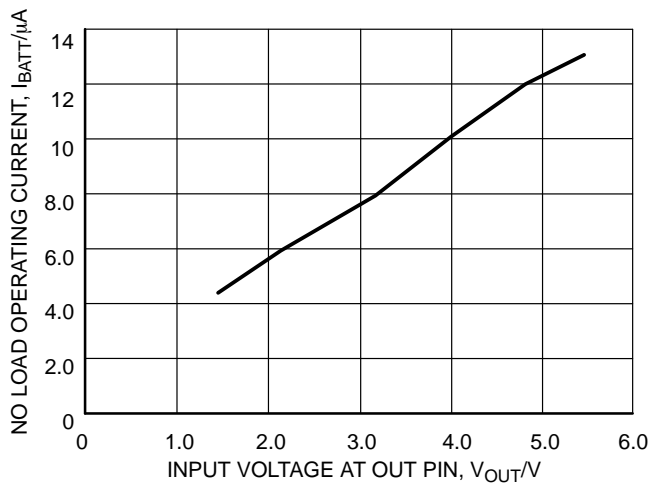
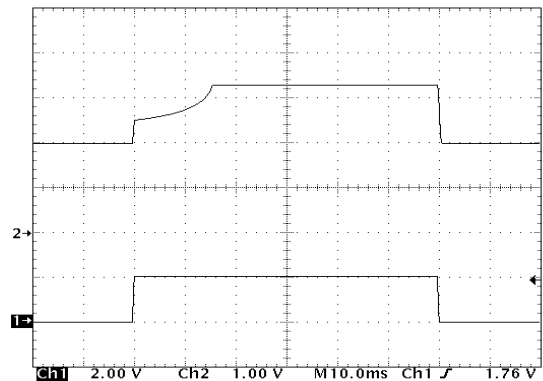

Figure 19. No Load Operating Current vs. Input Voltage at OUT Pin



Upper Trace: Output Voltage Waveform, 2.0 V/Division
Lower Trace: Shutdown Pin Waveform, 1.0 V/Division

Figure 20. Startup Transient Response

TYPICAL OPERATING CHARACTERISTICS

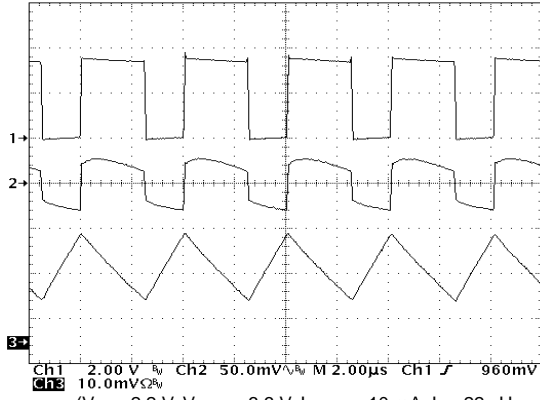

Upper Trace: Voltage at L_X pin, 2.0 V/Division
 Middle Trace: Output Voltage Ripple, 50 mV/Division
 Lower Trace: Inductor Current, I_L , 100 mA/Division
Figure 21. Continuous Conduction Mode Switching Waveform

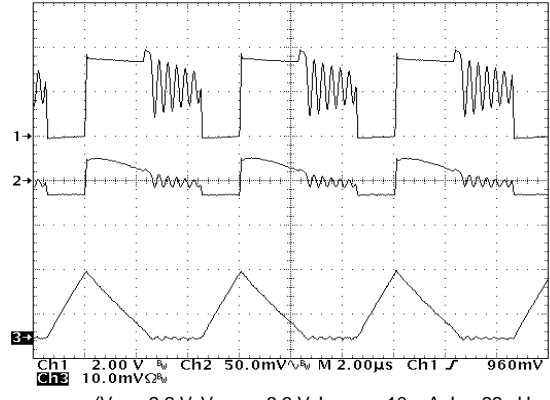

Upper Trace: Voltage at L_X pin, 2.0 V/Division
 Middle Trace: Output Voltage Ripple, 50 mV/Division
 Lower Trace: Inductor Current, I_L , 100 mA/Division
Figure 22. Discontinuous Conduction Mode Switching Waveform

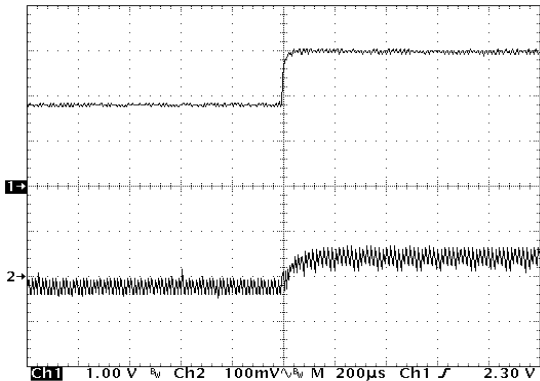

Upper Trace: Battery Voltage, V_{IN} , 1.0 V/Division
 Lower Trace: Output Voltage Ripple, 100 mV/Division
Figure 23. Line Transient Response for $V_{OUT} = 3.3$ V

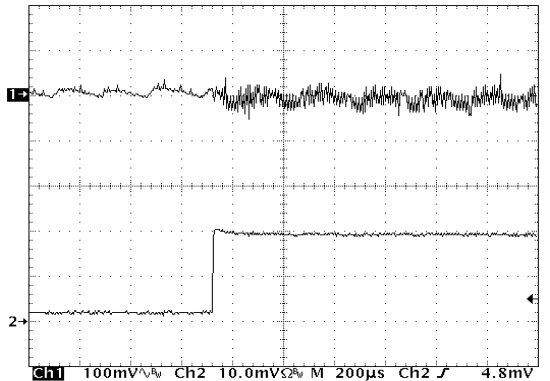

Upper Trace: Output Voltage Ripple, 100 mV/Division
 Lower Trace: Load Current, I_{LOAD} , 50 mA/Division
Figure 24. Load Transient Response for $V_{IN} = 1.8$ V

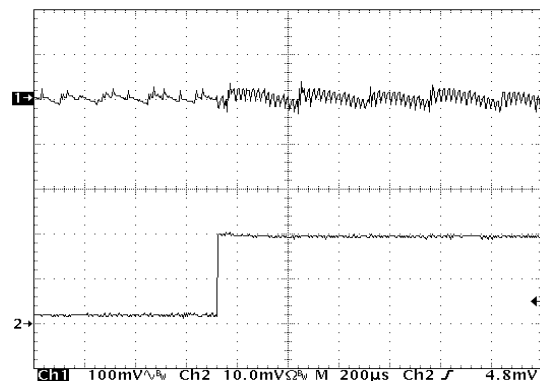

Upper Trace: Output Voltage Ripple, 100 mV/Division
 Lower Trace: Load Current, I_{LOAD} , 50 mA/Division
Figure 25. Load Transient Response for $V_{IN} = 2.4$ V

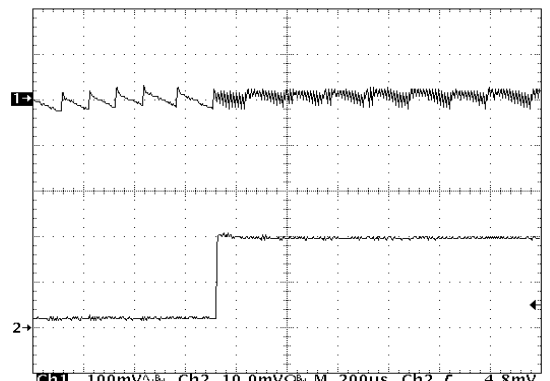

Upper Trace: Output Voltage Ripple, 100 mV/Division
 Lower Trace: Load Current, I_{LOAD} , 50 mA/Division
Figure 26. Load Transient Response for $V_{IN} = 3.3$ V

DETAILED OPERATION DESCRIPTIONS

NCP1410 is a monolithic micropower high frequency step-up voltage switching converter IC specially designed for battery operated hand-held electronic products up to 250 mA loading. It integrates Synchronous Rectifier for improving efficiency as well as eliminating the external Schottky Diode. High switching frequency (up to 600 kHz) allows low profile inductor and output capacitor being used. Low-Battery Detector, Logic-Controlled Shutdown and Cycle-by-Cycle Current Limit provide value-added features for various battery-operated application. With all these functions ON, the quiescent supply current is only 9.0 μ A typical. This device is available in a compact Micro8 package.

PFM Regulation Scheme

From the simplified Functional Diagram (Figure 2), the output voltage is divided down and fed back to pin 1 (FB). This voltage goes to the non-inverting input of the PFM comparator whereas the comparator's inverting input is connected to REF. A switching cycle is initiated by the falling edge of the comparator, at the moment, the main switch (M1) is turned ON. After the maximum ON-time (typical 1.4 μ S) elapses or the current limit is reached, M1 is turned OFF, and the synchronous switch (M2) is turned ON. The M1 OFF time is not less than the minimum OFF-time (typical 0.31 μ S), this is to ensure energy transfer from the inductor to the output capacitor. If the regulator is operating at continuous conduction mode (CCM), M2 is turned OFF just before M1 is supposed to be ON again. If the regulator is operating at discontinuous conduction mode (DCM), which means the coil current will decrease to zero before the next cycle, M1 is turned OFF as the coil current is almost reaching zero. The comparator (ZLC) with fixed offset is dedicated to sense the voltage drop across M2 as it is conducting, when the voltage drop is below the offset, the ZLC comparator output goes HIGH, and M2 is turned OFF. Negative feedback of closed loop operation regulates voltage at pin 1 (FB) equal to the internal voltage reference (1.190 V).

Synchronous Rectification

Synchronous Rectifier is used to replace Schottky Diode for eliminating the conduction loss contributed by forward voltage of the latter. Synchronous Rectifier is normally realized by powerFET with gate control circuitry which, however, involved relative complicated timing concerns.

As main switch M1 is being turned OFF, if the synchronous switch M2 is just turned ON with M1 not being completely turned OFF, current will be shunt from the output bulk capacitor through M2 and M1 to ground. This power loss lowers overall efficiency. So a certain amount of dead time is introduced to make sure M1 is completely OFF before M2 is being turned ON.

When the main regulator is operating in CCM, as M2 is being turned OFF, and M1 is just turned ON with M2 not being completely OFF, the above mentioned situation will occur. So dead time is introduced to make sure M2 is completely OFF before M1 is being turned ON.

When the regulator is operating in DCM, as coil current is dropped to zero, M2 is supposed to be OFF. Fail to do so, reverse current will flow from the output bulk capacitor through M2 and then the inductor to the battery input. It causes damage to the battery. So the ZLC comparator comes with fixed offset voltage to switch M2 OFF before any reverse current builds up. However, if M2 is switch OFF too early, large residue coil current flows through the body diode of M2 and increases conduction loss. Therefore, determination on the offset voltage is essential for optimum performance.

With the implementation of synchronous rectification, efficiency can be as high as 92%. For single cell input voltage, use an external Schottky diode such as MBR0520 connected from pin 7 to pin 8 to ensure start-up.

Cycle-by-Cycle Current Limit

From Figure 2, SENSEFET is applied to sample the coil current as M1 is ON. With that sample current flowing through a sense resistor, sense-voltage is developed. Threshold detector (ILIM) detects whether the sense-voltage is higher than preset level. If it happens, detector output signifies the CONTROL LOGIC to switch OFF M1, and M1 can only be switched ON as next cycle starts after the minimum OFF-time (typical 0.31 μ S). With properly sizing of SENSEFET and sense resistor, the peak coil current limit is set at 1.0 A typically.

Voltage Reference

The voltage at REF is set typically at +1.190 V. It can output up to 2.5 mA with load regulation $\pm 1.5\%$, at V_{OUT} equal to 3.3 V. If V_{OUT} is increased, the REF load capability can also be increased. A bypass capacitor of 0.15 μ F is required for proper operation when REF is not loaded. If REF is loaded, 1.0 μ F capacitor at REF is needed.

Shutdown

The IC is shutdown when the voltage at pin 5 (\overline{SHDN}) is pulled lower than 0.3 V. During shutdown, M1 and M2 are both switched OFF, however, the body diode of M2 allows current flow from battery to the output, the IC internal circuit will consume less than 0.05 μ A current typically. If the pin 5 voltage is pull higher than 0.6 V, for example, by a resistor connected to VIN, the IC is enabled, and the internal circuit will only consume 9.0 μ A current typically from the OUT pin. Refer to Figure 2, the product of R_{SHDN} and C_{SHDN} must be larger than (500 k \cdot 56 nF, i.e. 28 msec). This is to provide reset pulse for startup as battery is plugged in.

Low-Battery Detection

A comparator with 30 mV hysteresis is applied to perform the low-battery detection function. When pin 2 (LBI) is at a voltage, which can be defined by a resistor divider from the battery voltage, lower than the internal reference voltage, 1.190 V, the comparator output will cause a 50 Ohm low side switch to be turned ON. It will pull down the voltage at pin 3 (LBO) which has a hundreds kilo-Ohm of pull-high resistance. If the pin 2 voltage is higher than 1.190 V + 30 mV, the comparator output will cause the 50 Ohm low side switch to be turned OFF, pin 3 will become high impedance, and its voltage will be pulled high by the external resistor.

APPLICATIONS INFORMATION

Output Voltage Setting

The output voltage of the converter is determined by the external feedback network comprised of R_{FB1} and R_{FB2} and the relationship is given by:

$$V_{OUT} = 1.190 \text{ V} \times \left(1 + \frac{R_{FB1}}{R_{FB2}} \right)$$

where R_{F2} and R_{F1} are the upper and lower feedback resistors respectively.

Low Battery Detect Level Setting

The Low Battery Detect Voltage of the converter is determined by the external divider network comprised of R_{LB1} and R_{LB2} and the relationship is given by:

$$V_{LB} = 1.190 \text{ V} \times \left(1 + \frac{R_{LB1}}{R_{LB2}} \right)$$

where R_{LB1} and R_{LB2} are the upper and lower divider resistors respectively.

Inductor Selection

The NCP1410 is tested to produce optimum performance with a 22 μH inductor at V_{IN} = 3 V, V_{OUT} = 3.3 V supplying output current up to 250 mA. For other input/output requirements, inductance in the range 10 μH to 47 μH can be used according to end application specifications. Selecting an inductor is a compromise between output current capability and tolerable output voltage ripple. Of course, the first thing we need to obey is to keep the peak inductor current below its saturation limit at maximum current and the I_{LIM} of the device. In NCP1410, I_{LIM} is set at 1 A. As a rule of thumb, low inductance values supply higher output current, but also increase the ripple at output and reducing efficiency, on the other hand, high inductance values can improve output ripple and efficiency, however it also limit the output current capability at the same time. One other parameter of the inductor is its DC resistance, this resistance can introduce unwanted power loss and hence reduce overall efficiency, the basic rule is selecting an inductor with lowest DC resistance within the board space limitation of the end application.

Capacitors Selection

In all switching mode boost converter applications, both the input and output terminals sees pulsating voltage/current waveforms. The currents flowing into and out of the capacitors multiplying with the Equivalent Series Resistance (ESR) of the capacitor producing ripple voltage at the terminals. During the syn-rect switch off cycle, the charges stored in the output capacitor is used to sustain the output load current. Load current at this period and the ESR combined and reflected as ripple at the output terminals. For all cases, the lower the capacitor ESR, the lower the ripple voltage at output. As a general guide line, low ESR capacitors should be used. Ceramic capacitors have the lowest ESR, but low ESR tantalum capacitors can also be used as a cost effective substitute.

Optional Startup Schottky Diode for Low Battery Voltage

In general operation, no external Schottky diode is required, however, in case you are intended to operate the device close to 1 V level, a Schottky diode connected between the LX and OUT pins as shown in Figure 27 can help during startup of the converter. The effect of the additional Schottky was shown in Figure 8.

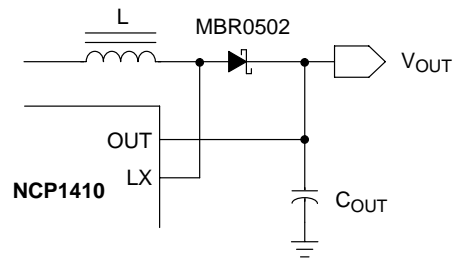

Figure 27. Schottky Device Between LX and OUT Pins

PCB Layout Recommendations

Good PCB layout plays an important role in switching mode power conversion. Careful PCB layout can help to minimize ground bounce, EMI noise and unwanted feedback that can affect the performance of the converter. Hints in the following paragraphs, can be used as guidelines in most situations.

Grounding

Star-ground connection should be used to connect the output power return ground, the input power return ground and the device power ground together at one point. All high current running paths must be thick enough for current flowing through and producing insignificant voltage drop along the path. Feedback signal path must be separated with the main current path and sensing directly at the anode of the output capacitor.

NCP1410

Components Placement

Power components, i.e. input capacitor, inductor and output capacitor, must be placed as close together as possible. All connecting traces must be short, direct and thick. High current flowing and switching paths must be kept away from the feedback (FB, pin 1) terminal to avoid unwanted injection of noise into the feedback path.

Feedback Network

Feedback of the output voltage must be a separate trace detached from the power path. External feedback network must be placed very close to the feedback (FB, pin 1) and sensing the output voltage directly at the anode of the output capacitor.

TYPICAL APPLICATION CIRCUIT

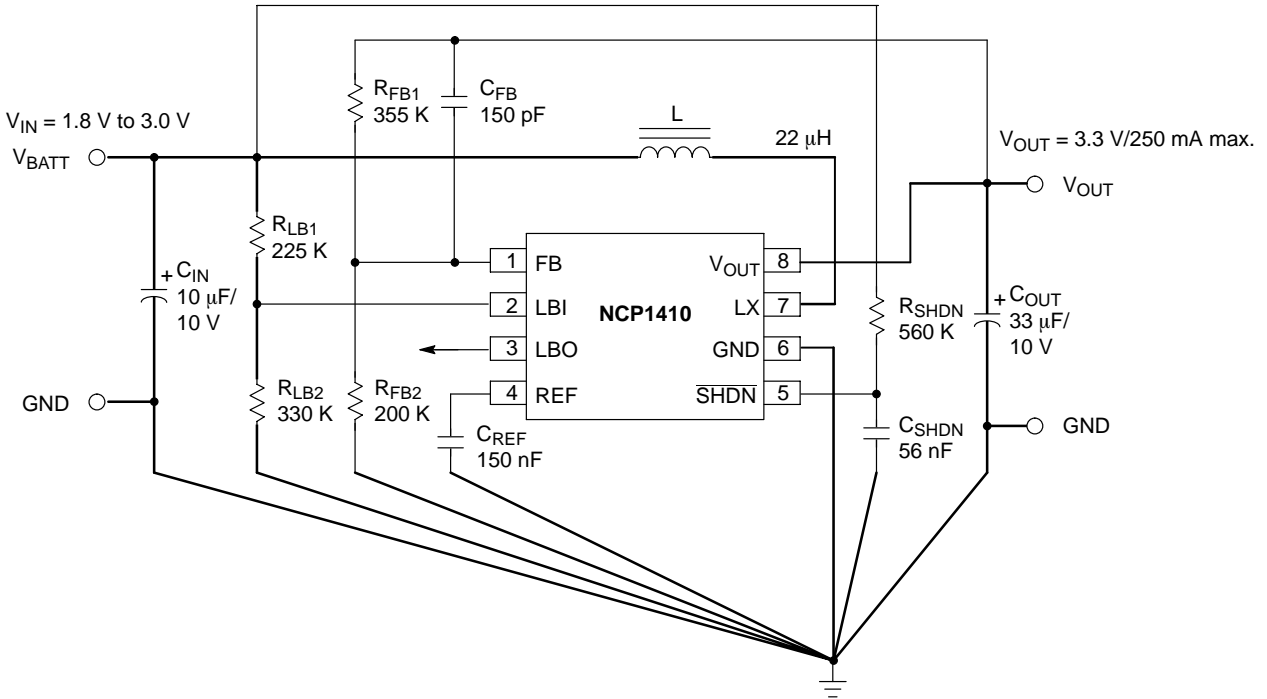

Figure 28. Typical Application Schematic for 2 Alkaline Cells Supply

GENERAL DESIGN PROCEDURES

Switching mode converter design is considered as black magic to most engineers, some complicate empirical formulae are available for reference usage. Those formulae are derived from the assumption that the key components, i.e. power inductor and capacitors are available with no tolerance. Practically, its not true, the result is not a matter of how accurate the equations you are using to calculate the component values, the outcome is still somehow away from the optimum point. In below a simple method base on the most basic first order equations to estimate the inductor and capacitor values for NCP1410 operate in Continuous Conduction Mode is introduced. The component value set can be used as a starting point to fine tune the circuit operation. By all means, detail bench testing is needed to get the best performance out of the circuit.

Design Parameters:

- $V_{IN} = 1.8 \text{ V to } 3.0 \text{ V, Typical } 2.4 \text{ V}$
- $V_{OUT} = 3.3 \text{ V}$
- $I_{OUT} = 200 \text{ mA (250 mA max)}$
- $V_{LB} = 2.0 \text{ V}$
- $V_{OUT-RIPPLE} = 40 \text{ mV}_{P-P} \text{ at } I_{OUT} = 250 \text{ mA}$

Calculate the feedback network:

Select $R_{FB2} = 200 \text{ K}$

$$R_{FB1} = R_{FB2} \left(\frac{V_{OUT}}{V_{REF}} - 1 \right)$$

$$R_{FB1} = 200 \text{ K} \left(\frac{3.3 \text{ V}}{1.19 \text{ V}} - 1 \right) = 355 \text{ K}$$

Calculate the Low Battery Detect divider:

- $V_{LB} = 2.0 \text{ V}$
- Select $R_{LB2} = 330 \text{ K}$

$$R_{LB1} = R_{LB2} \left(\frac{V_{LB}}{V_{REF}} - 1 \right)$$

$$R_{LB1} = 330 \text{ K} \left(\frac{2.0 \text{ V}}{1.19 \text{ V}} - 1 \right) = 225 \text{ K}$$

Determine the Steady State Duty Ratio, D for typical V_{IN} , operation will be optimized around this point:

$$\frac{V_{OUT}}{V_{IN}} = \frac{1}{1 - D}$$

$$D = 1 - \frac{V_{IN}}{V_{OUT}} = 1 - \frac{2.4 \text{ V}}{3.3 \text{ V}} = 0.273$$

Determine the average inductor current, I_{LAVG} at maximum I_{OUT} :

$$I_{LAVG} = \frac{I_{OUT}}{1 - D} = \frac{250 \text{ mA}}{1 - 0.273} = 344 \text{ mA}$$

Determine the peak inductor ripple current, $I_{RIPPLE-P}$ and calculate the inductor value:

Assume $I_{RIPPLE-P}$ is 20% of I_{LAVG} , the inductance of the power inductor can be calculated as in below:

$$I_{RIPPLE-P} = 0.20 \times 344 \text{ mA} = 68.8 \text{ mA}$$

$$L = \frac{V_{IN} \times t_{ON}}{2 I_{RIPPLE-P}} = \frac{2.4 \text{ V} \times 1.4 \mu\text{S}}{2(68.8 \text{ mA})} = 24.4 \mu\text{H}$$

Standard value of 22 μH is selected for initial trial.

Determine the output voltage ripple, $V_{OUT-RIPPLE}$ and calculate the output capacitor value:

$V_{OUT-RIPPLE} = 40 \text{ mV}_{P-P} \text{ at } I_{OUT} = 250 \text{ mA}$

$$C_{OUT} > \frac{I_{OUT} \times t_{ON}}{V_{OUT-RIPPLE} - I_{OUT} \times ESR_{COUT}}$$

where $t_{ON} = 1.4 \mu\text{S}$ and $ESR_{COUT} = 0.1 \Omega$,

$$C_{OUT} > \frac{250 \text{ mA} \times 1.4 \mu\text{S}}{40 \text{ mV} - 250 \text{ mA} \times 0.1 \Omega} = 23.33 \mu\text{F}$$

From above calculation, you need at least 23.33 μF in order to achieve the specified ripple level at conditions stated. Practically, a one level larger capacitor will be used to accommodate factors not take into account in the calculation, therefore a capacitor value of 33 μF is selected.

NCP1410

PACKAGE DIMENSIONS

Micro8
DM SUFFIX
CASE 846A-02
ISSUE F

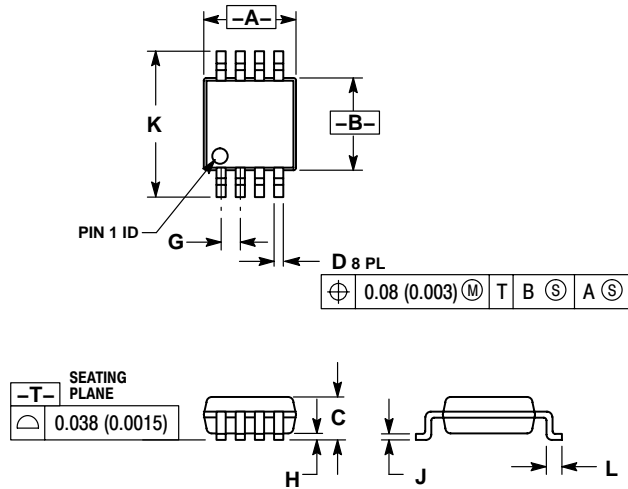

NOTES:

1. DIMENSIONING AND TOLERANCING PER ANSI Y14.5M, 1982.
2. CONTROLLING DIMENSION: MILLIMETER.
3. DIMENSION A DOES NOT INCLUDE MOLD FLASH, PROTRUSIONS OR GATE BURRS. MOLD FLASH, PROTRUSIONS OR GATE BURRS SHALL NOT EXCEED 0.15 (0.006) PER SIDE.
4. DIMENSION B DOES NOT INCLUDE INTERLEAD FLASH OR PROTRUSION. INTERLEAD FLASH OR PROTRUSION SHALL NOT EXCEED 0.25 (0.010) PER SIDE.
5. 846A-01 OBSOLETE, NEW STANDARD 846A-02.

| DIM | MILLIMETERS | | INCHES | |
|-----|-------------|------|-----------|-------|
| | MIN | MAX | MIN | MAX |
| A | 2.90 | 3.10 | 0.114 | 0.122 |
| B | 2.90 | 3.10 | 0.114 | 0.122 |
| C | --- | 1.10 | --- | 0.043 |
| D | 0.25 | 0.40 | 0.010 | 0.016 |
| G | 0.65 BSC | | 0.026 BSC | |
| H | 0.05 | 0.15 | 0.002 | 0.006 |
| J | 0.13 | 0.23 | 0.005 | 0.009 |
| K | 4.75 | 5.05 | 0.187 | 0.199 |
| L | 0.40 | 0.70 | 0.016 | 0.028 |

SOLDERING FOOTPRINT*

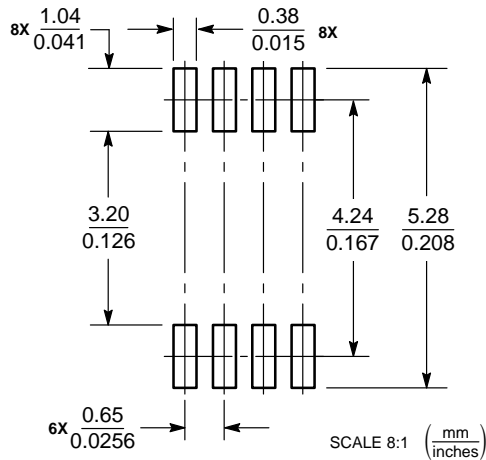

*For additional information on our Pb-Free strategy and soldering details, please download the ON Semiconductor Soldering and Mounting Techniques Reference Manual, SOLDERRM/D.

NCP1410

Micro8 is a trademark of International Rectifier.

ON Semiconductor and  are registered trademarks of Semiconductor Components Industries, LLC (SCILLC). SCILLC reserves the right to make changes without further notice to any products herein. SCILLC makes no warranty, representation or guarantee regarding the suitability of its products for any particular purpose, nor does SCILLC assume any liability arising out of the application or use of any product or circuit, and specifically disclaims any and all liability, including without limitation special, consequential or incidental damages. "Typical" parameters which may be provided in SCILLC data sheets and/or specifications can and do vary in different applications and actual performance may vary over time. All operating parameters, including "Typicals" must be validated for each customer application by customer's technical experts. SCILLC does not convey any license under its patent rights nor the rights of others. SCILLC products are not designed, intended, or authorized for use as components in systems intended for surgical implant into the body, or other applications intended to support or sustain life, or for any other application in which the failure of the SCILLC product could create a situation where personal injury or death may occur. Should Buyer purchase or use SCILLC products for any such unintended or unauthorized application, Buyer shall indemnify and hold SCILLC and its officers, employees, subsidiaries, affiliates, and distributors harmless against all claims, costs, damages, and expenses, and reasonable attorney fees arising out of, directly or indirectly, any claim of personal injury or death associated with such unintended or unauthorized use, even if such claim alleges that SCILLC was negligent regarding the design or manufacture of the part. SCILLC is an Equal Opportunity/Affirmative Action Employer. This literature is subject to all applicable copyright laws and is not for resale in any manner.

PUBLICATION ORDERING INFORMATION

LITERATURE FULFILLMENT:

Literature Distribution Center for ON Semiconductor
P.O. Box 61312, Phoenix, Arizona 85082-1312 USA
Phone: 480-829-7710 or 800-344-3860 Toll Free USA/Canada
Fax: 480-829-7709 or 800-344-3867 Toll Free USA/Canada
Email: orderlit@onsemi.com

N. American Technical Support: 800-282-9855 Toll Free
USA/Canada

Japan: ON Semiconductor, Japan Customer Focus Center
2-9-1 Kamimeguro, Meguro-ku, Tokyo, Japan 153-0051
Phone: 81-3-5773-3850

ON Semiconductor Website: <http://onsemi.com>

Order Literature: <http://www.onsemi.com/litorder>

For additional information, please contact your
local Sales Representative.