

Fiber Optic PIN Photodiode Type OPF420

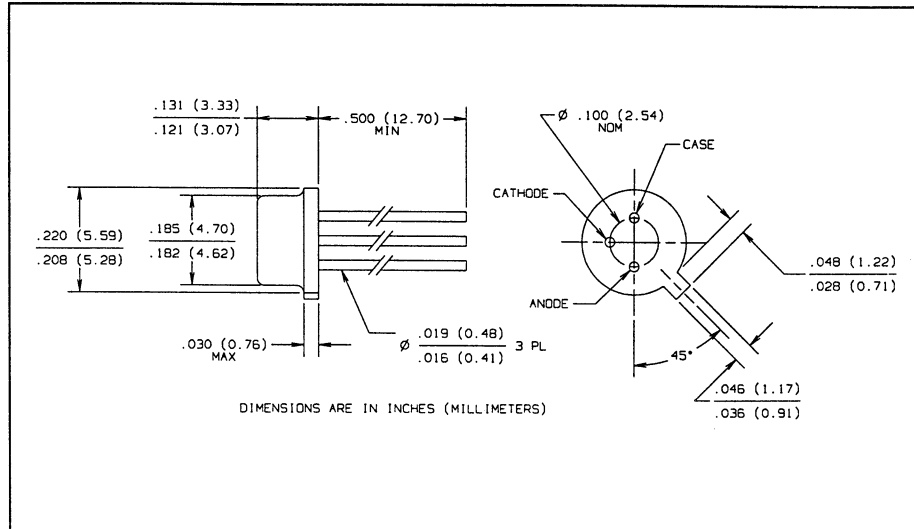
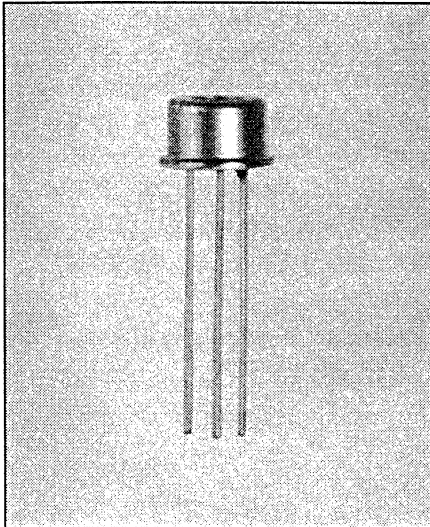

Features

- Electrically isolated TO-46 package
- High speed, low capacitance
- Optimized for fiber optic applications using 50 to 200 micron fiber

Description

The OPF420 is a low noise silicon PIN photodiode mounted in a special TO-46 package for fiber optic applications. It offers fast response at moderate bias and is compatible with LED and laser diode sources in the 800-900 nm wavelength region. Low capacitance improves signal to noise performance in typical short haul LAN applications.

The PIN Photodiodes are designed to interface with multimode optical fibers from 50/125 to 200/300 microns.

Absolute Maximum Ratings (T_A = 25° C unless otherwise noted)

Reverse Voltage	100 VDC
Continuous Power Dissipation	200 mW ⁽¹⁾
Storage Temperature Range	-65° C to +150° C
Operating Temperature Range	-55° C to +125° C
Lead Soldering Temperature [1/16 inch (1.6 mm) from case for 5 sec. with soldering iron]	240° C ⁽²⁾

Notes:

- (1) Derate linearly @ 2.0 mW/° C above 25° C.
- (2) RMA flux is recommended. Duration can be extended to 10 sec. max when flow soldering.
- (3) Test @ V_R = 5 V with 50/125 micron, 0.20 N.A. fiber, @ 10 μW optical power @ 850 nm. Responsivity levels apply to 50 μm, 62.5 μm and 100 μm core optical fibers.
- (4) R_L = 50 Ω, 10%-90%

Typical Performance Curves

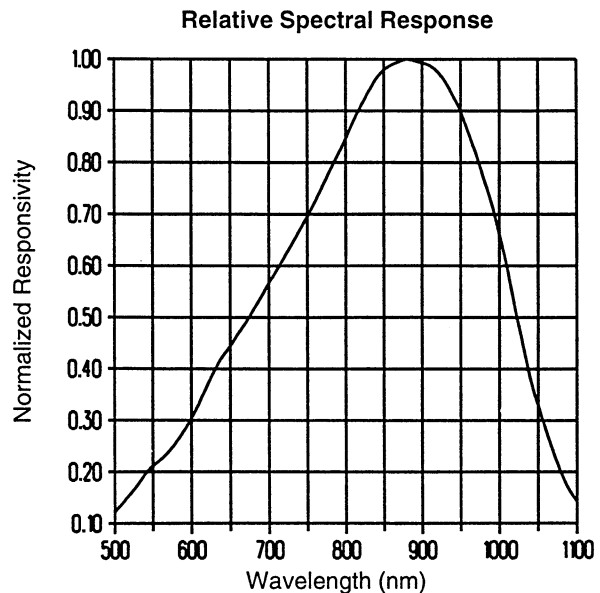

Type OPF420

Electrical Characteristics ($T_A = 25^\circ\text{C}$ unless otherwise noted)

SYMBOL	PARAMETER	MIN	TYP	MAX	UNITS	TEST CONDITIONS
R	Flux Responsivity	0.45	0.55		A/W	$V_R = 5.0\text{ V}^{(3)}$
I_D	Dark Current		0.1	5.0	nA	$V_R = 5.0\text{ V}$
λ_p	Peak Response Wavelength		880		nm	
t_r	Output Rise Time		6.0		ns	$V_R = 15\text{ V}^{(4)}$
C_T	Total Capacitance		3.0		pF	$V_R = 20\text{ V}$
FoV	Field of View		80		Deg.	

TYPICAL PERFORMANCE CURVES

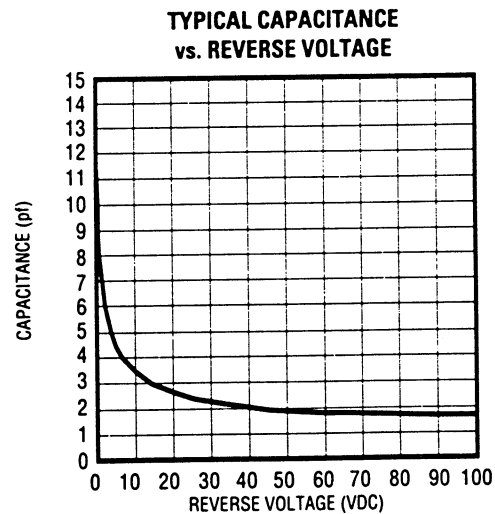
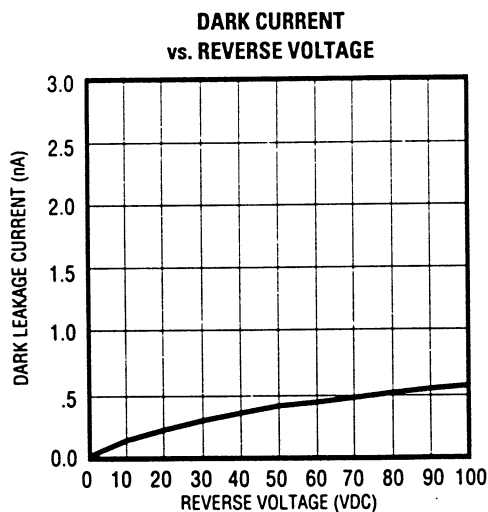
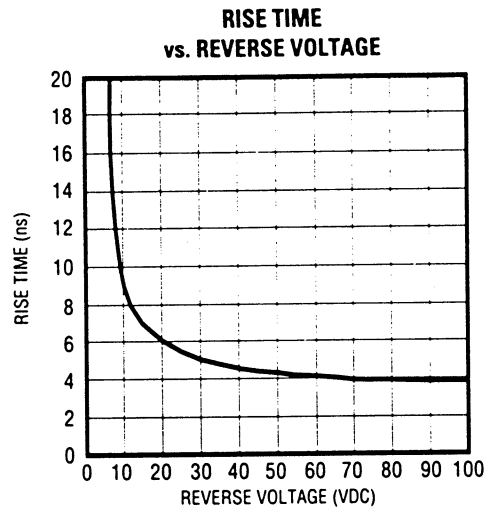
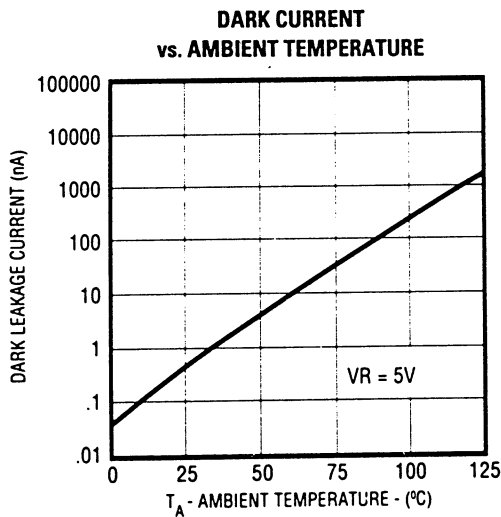

FIBER OPTIC
COMPONENTS