



P-Channel 60-V (D-S) MOSFET

PRODUCT SUMMARY		
V_{DS} (V)	$r_{DS(on)}$ (Ω)	I_D (A)
-60	0.065 @ $V_{GS} = -10$ V	-5.7
	0.110 @ $V_{GS} = -4.5$ V	-4.4

FEATURES

- TrenchFET® Power MOSFET
- New PowerPAK™ Package
 - Low Thermal Resistance, R_{thJC}
 - Low 1.07-mm Profile
- Fast Switching

APPLICATIONS

- Load Switches
- Half-Bridge Motor Drives
- High voltage Non-Synchronous Buck Converters

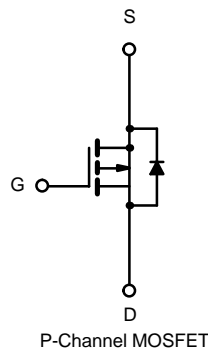
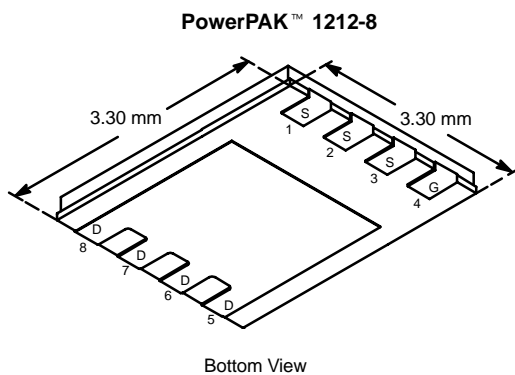

ABSOLUTE MAXIMUM RATINGS ($T_A = 25^\circ\text{C}$ UNLESS OTHERWISE NOTED)					
Parameter	Symbol	10 secs	Steady State	Unit	
Drain-Source Voltage	V_{DS}	-60		V	
Gate-Source Voltage	V_{GS}	± 20			
Continuous Drain Current ($T_J = 150^\circ\text{C}$) ^a	I_D	$T_A = 25^\circ\text{C}$	-5.7	-3.6	A
		$T_A = 70^\circ\text{C}$	-4.6	-2.9	
Pulsed Drain Current	I_{DM}	-20			
continuous Source Current (Diode Conduction) ^a	I_S	-3.2	-1.3		
Maximum Power Dissipation ^a	P_D	$T_A = 25^\circ\text{C}$	3.8	1.5	W
		$T_A = 70^\circ\text{C}$	2.0	0.8	
Operating Junction and Storage Temperature Range	T_J, T_{stg}	-55 to 150		$^\circ\text{C}$	

THERMAL RESISTANCE RATINGS					
Parameter	Symbol	Typical	Maximum	Unit	
Maximum Junction-to-Ambient ^a	R_{thJA}	$t \leq 10$ sec	26	33	$^\circ\text{C/W}$
		Steady State	65	81	
Maximum Junction-to-Case (Drain)	R_{thJC}	1.9	2.4		

Notes

a. Surface Mounted on 1" x 1" FR4 Board.

SPECIFICATIONS (T_J = 25 °C UNLESS OTHERWISE NOTED)

Parameter	Symbol	Test Condition	Min	Typ	Max	Unit
Static						
Gate Threshold Voltage	V _{GS(th)}	V _{DS} = V _{GS} , I _D = -250 μA	-1			V
Gate-Body Leakage	I _{GSS}	V _{DS} = 0 V, V _{GS} = ±20 V			±100	nA
Zero Gate Voltage Drain Current	I _{DSS}	V _{DS} = -48 V, V _{GS} = 0 V			-1	μA
		V _{DS} = -48 V, V _{GS} = 0 V, T _J = 70 °C			-5	
On-State Drain Current ^a	I _{D(on)}	V _{DS} ≤ -5 V, V _{GS} = -10 V	-20			A
Drain-Source On-State Resistance ^a	r _{DS(on)}	V _{GS} = -10 V, I _D = -5.7 A		0.054	0.065	Ω
		V _{GS} = -4.5 V, I _D = -4.4 A		0.090	0.110	
Forward Transconductance ^a	g _{fs}	V _{DS} = -15 V, I _D = -5.7 A		11		S
Diode Forward Voltage ^a	V _{SD}	I _S = -3.2 A, V _{GS} = 0 V		-0.8	-1.2	V
Dynamic^b						
Total Gate Charge	Q _g	V _{DS} = -30 V, V _{GS} = -10 V, I _D = -5.7 A		15	25	nC
Gate-Source Charge	Q _{gs}			4		
Gate-Drain Charge	Q _{gd}			3.2		
Turn-On Delay Time	t _{d(on)}	V _{DD} = -30 V, R _L = 30 Ω I _D ≅ -1 A, V _{GEN} = -10 V, R _G = 6 Ω		12	20	ns
Rise Time	t _r			12	20	
Turn-Off Delay Time	t _{d(off)}			22	35	
Fall Time	t _f			16	25	
Source-Drain Reverse Recovery Time	t _{rr}		I _F = -3.2 A, di/dt = 100 A/μs		45	

Notes

- a. Pulse test; pulse width ≤ 300 μs, duty cycle ≤ 2%.
b. Guaranteed by design, not subject to production testing.

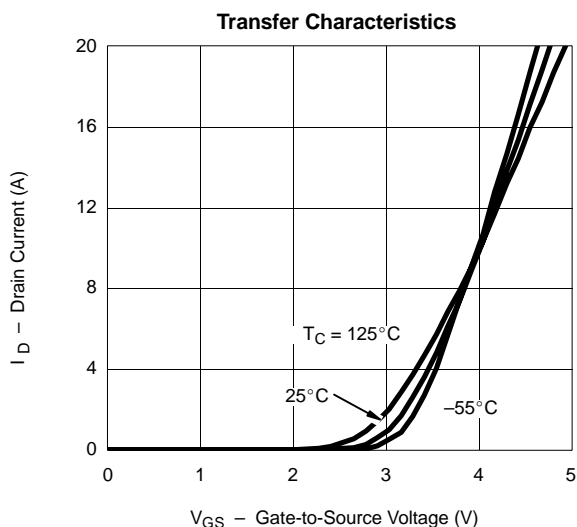
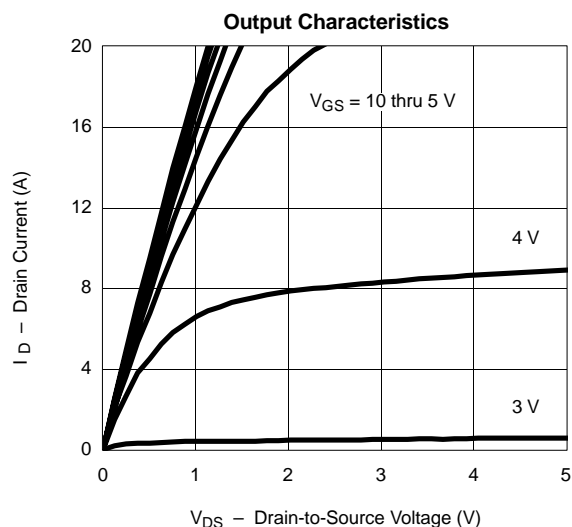
TYPICAL CHARACTERISTICS (25 °C UNLESS NOTED)



TYPICAL CHARACTERISTICS (25 °C UNLESS NOTED)

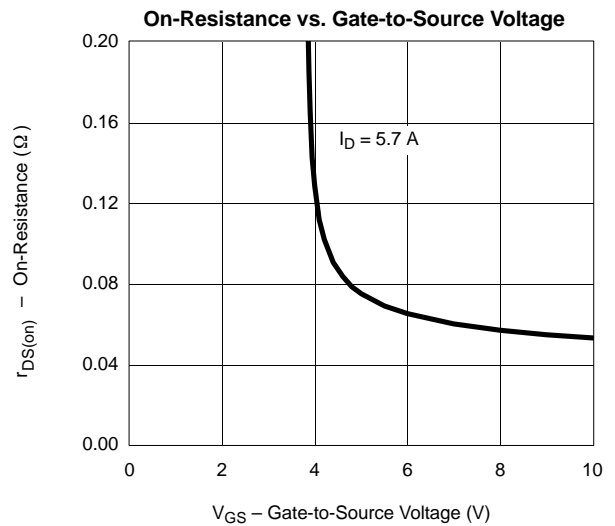
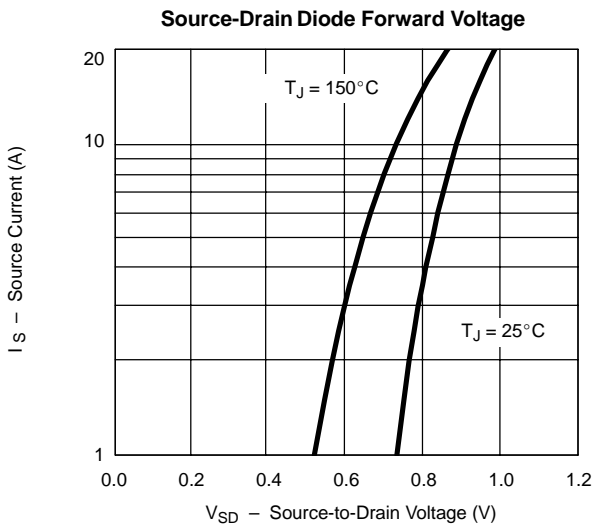
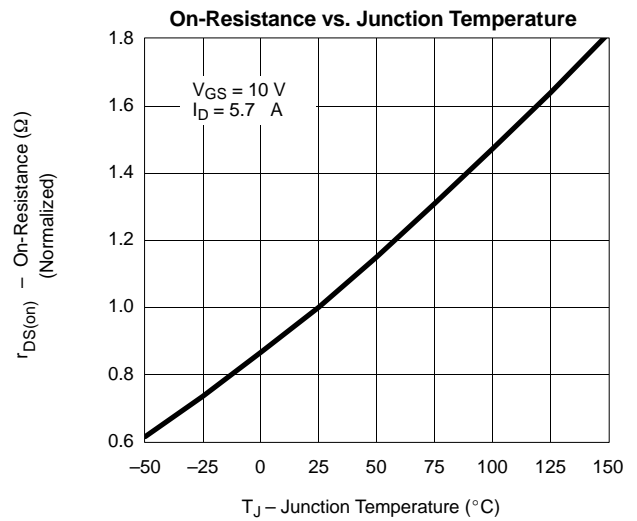
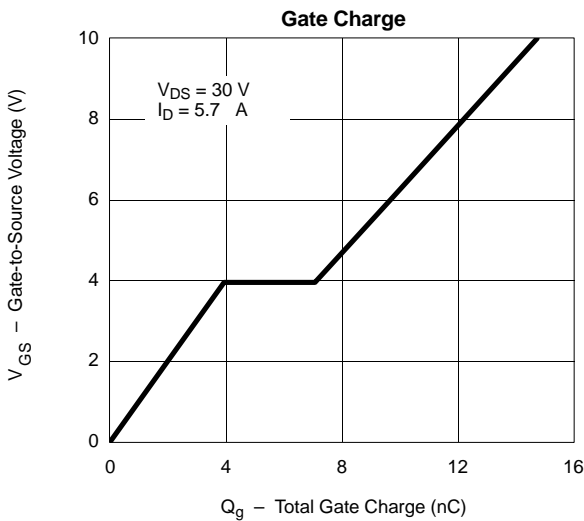
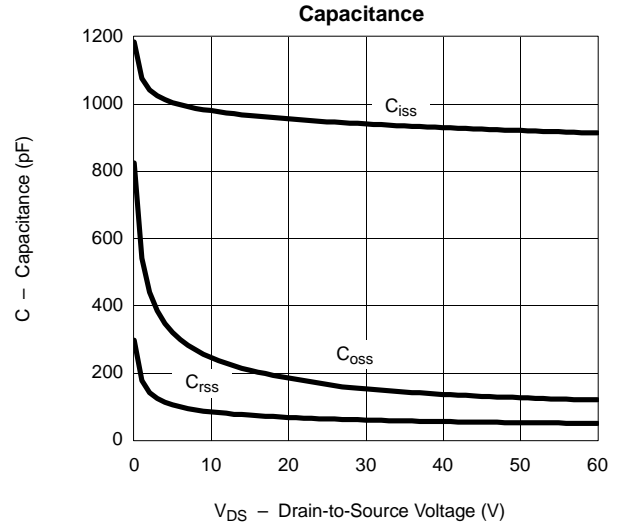
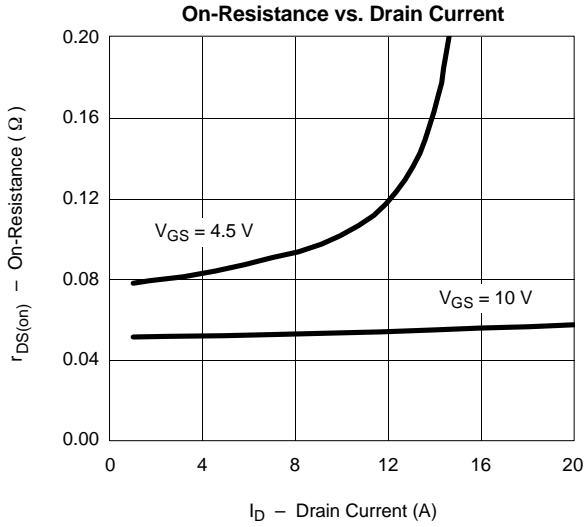

TYPICAL CHARACTERISTICS (25 °C UNLESS NOTED)

