

SP - 1KL

The SP - 1KL, a silicon photodiode mounted in durable, hermetically sealed TO - 18metal can package, provides years of reliable performance even under demanding conditions such as use outdoors.

FEATURES

- Narrow angular response
- Durable
- High reliability in demanding environments

APPLICATIONS

- Optical counters
- Optical switches
- Infrared sensors
- Encoders
- Smoke detectors
- Car electronics

DIMENSIONS

(Unit : mm)

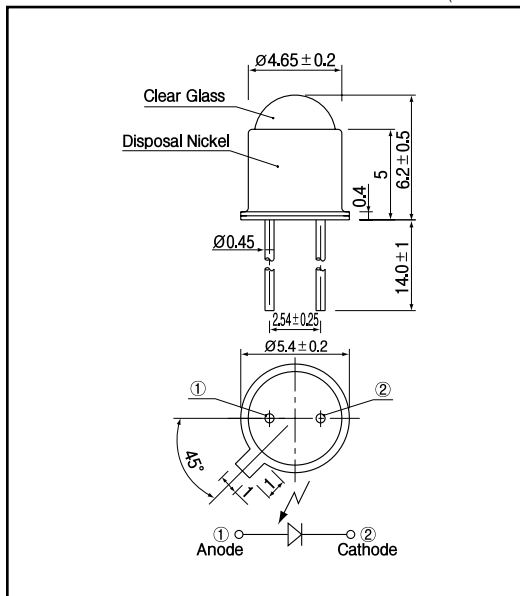

MAXIMUM RATINGS

(Ta=25)

Item	Symbol	Rating	Unit
Reverse voltage	V _r	20	V
Operating temp.	Topr.	- 25 ~ + 120	
Storage temp.	Tstg.	- 30 ~ + 150	
Soldering temp. *1	Tsol.	260	

*1. For MAX.5 seconds at the position of 2 mm from the package

ELECTRO-OPTICAL CHARACTERISTICS

(Ta=25)

Item	Symbol	Conditions	Min.	Typ.	Max.	Unit.
Open circuit voltage	V _{oc}	E _v = 1,000lx ⁻²	18	0.4		V
Short circuit current	I _{sc}			35		μA
Dark current	I _d	V _r = 5V			0.1	μA
Curve factor	C.F.		0.55			-
Capacitance	C _t	V = 0V, f = 1MHz		50		pF
Temperature coefficient of V _{oc}	t			- 2.2		mV/
Temperature coefficient of I _{sc}	t			0.18		%/
Spectral sensitivity				450 ~ 1,050		nm
Peak wavelength	ρ			900		nm
Half angle				± 15		deg.

*2. Color temp. = 2856K standard Tungsten lamp

Photo diodes

SP - 1KL

Light current Vs. Forward voltage

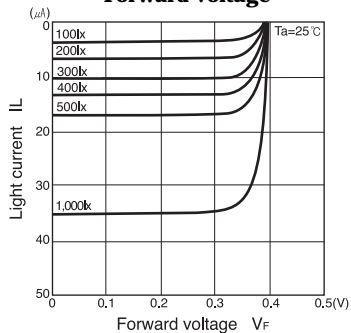

Short circuit current Vs. Illuminance

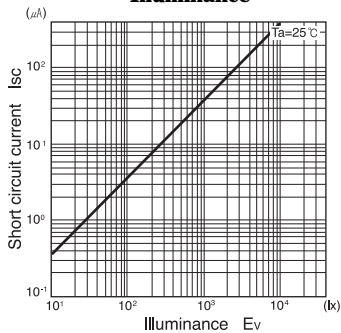

Dark current Vs. Ambient temperature

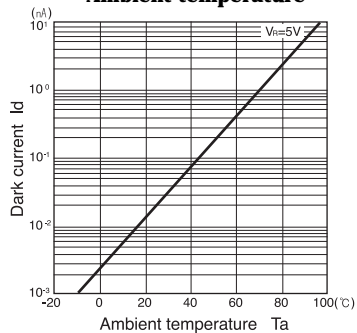

Relative sensitivity Vs. Wavelength

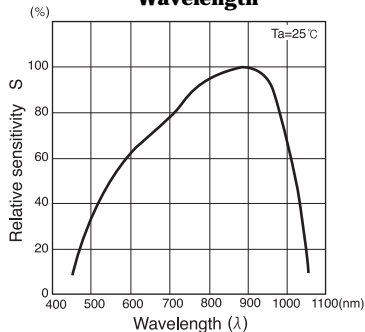

Dark current Vs. Reverse voltage

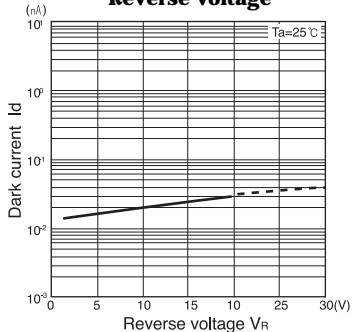

Radiant Pattern

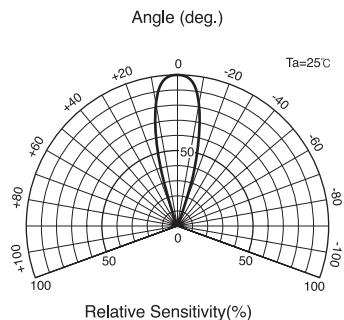

Capacitance between terminals Vs. Reverse voltage

