

# SR20200



## 20 AMP SCHOTTKY BARRIER RECTIFIERS



### FEATURES

- \* Low forward voltage drop
- \* High current capability
- \* High reliability
- \* High surge current capability
- \* Epitaxial construction

### MECHANICAL DATA

- \* Case: Molded plastic
- \* Epoxy: UL 94V-0 rate flame retardant
- \* Lead: Lead solderable per MIL-STD-202, method 208 guaranteed
- \* Polarity: As Marked
- \* Mounting position: Any
- \* Weight: 2.24 grams

### VOLTAGE RANGE

200 Volts

### CURRENT

20 Ampere

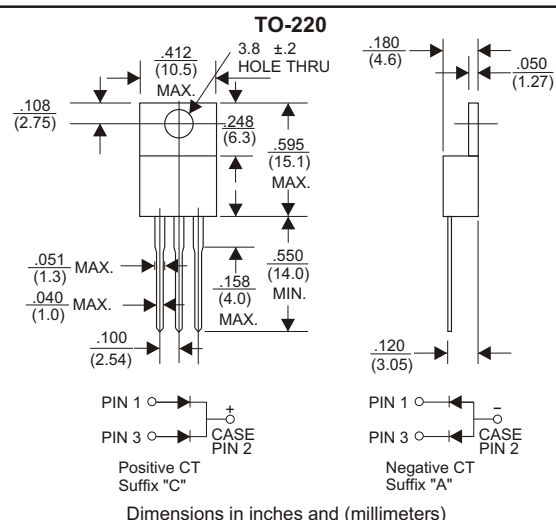

## MAXIMUM RATINGS AND ELECTRICAL CHARACTERISTICS

Rating 25°C ambient temperature unless otherwise specified.  
Single phase half wave, 60Hz, resistive or inductive load.  
For capacitive load, derate current by 20%.

TYPE NUMBER	SR20200	UNITS
Maximum Recurrent Peak Reverse Voltage	200	V
Maximum RMS Voltage	140	V
Maximum DC Blocking Voltage	200	V
Maximum Average Forward Rectified Current .375"(9.5mm) Lead Length at Tc=105°C	20	A
Peak Forward Surge Current, 8.3 ms single half sine-wave superimposed on rated load (JEDEC method)	200	A
Maximum Instantaneous Forward Voltage at 10A	0.90	V
Maximum DC Reverse Current Ta=25°C	0.02	mA
at Rated DC Blocking Voltage Ta=125°C	10	mA
Typical Junction Capacitance (Note1)	350	pF
Typical Thermal Resistance R JA (Note 2)	2.0	°C/W
Operating Temperature Range Tj	-55 — +150	°C
Storage Temperature Range Tstg	-55 — +175	°C

#### NOTES:

1. Measured at 1MHz and applied reverse voltage of 4.0V D.C.
2. Thermal Resistance Junction to Ambient Vertical PC Board Mounting 0.5"(12.7mm) Lead Length.

# RATING AND CHARACTERISTIC CURVES (SR20200)

FIG.1-TYPICAL FORWARD CURRENT DERATING CURVE

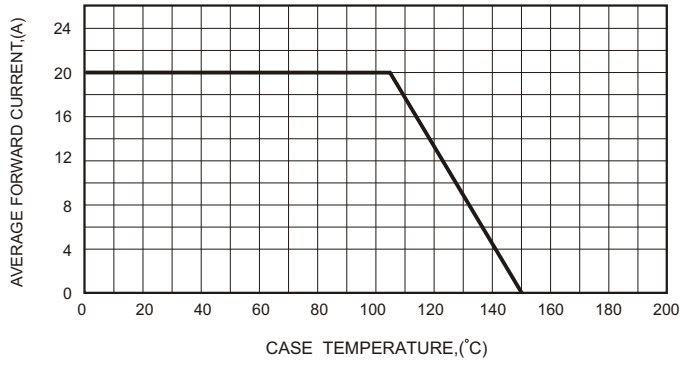

FIG.2-TYPICAL FORWARD CHARACTERISTICS

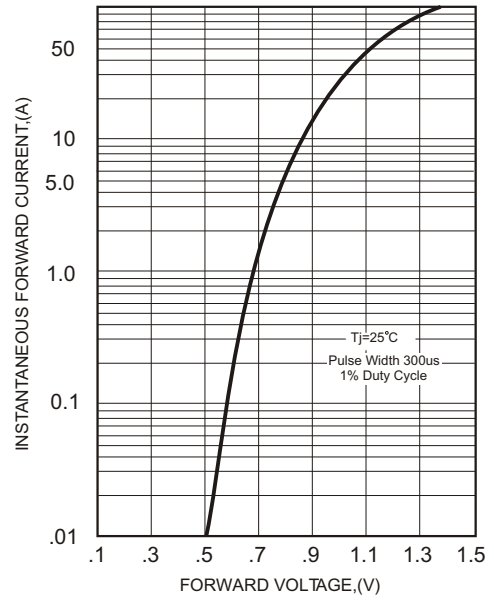

FIG.3-MAXIMUM NON-REPETITIVE FORWARD SURGE CURRENT

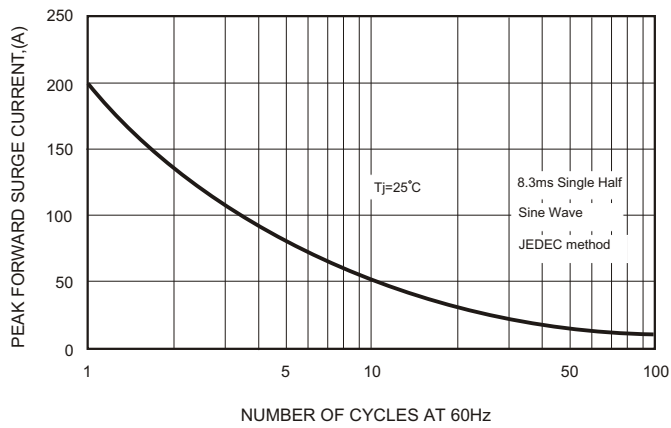

FIG.4-TYPICAL JUNCTION CAPACITANCE

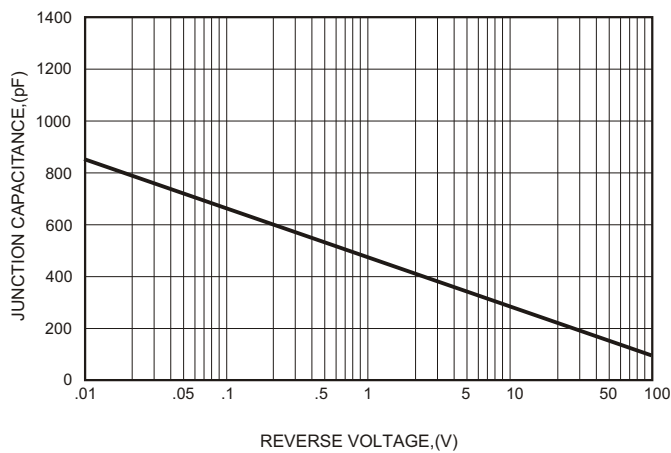

FIG.5 - TYPICAL REVERSE CHARACTERISTICS

