



# SRN3 THRU SRN7

## SURFACE MOUNT FAST SWITCHING RECTIFIER

Reverse Voltage - 50 to 600 Volts

Forward Current - 1.0 Ampere

### Features

- For surface mounted applications
- Low profile package
- Built-in strain relief
- Easy pick and place
- Fast recovery times for high efficiency
- Plastic package has Underwriters Laboratory Flammability Classification 94V-0
- High temperature soldering: 260°C/10 seconds at terminals

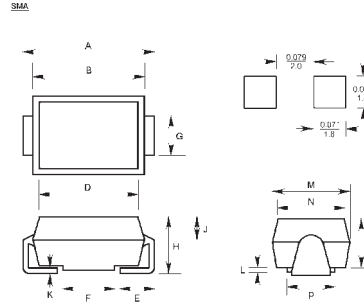

### Mechanical Data

- **Case:** SMA molded plastic
- **Terminals:** Solder plated solderable per MIL-STD-750, method 2026
- **Polarity:** Indicated by cathode band
- **Weight:** 0.004 ounce, 0.113 gram

DIM	DIMENSIONS				Note
	Inches		mm		
A	Min.	Max.	Min.	Max.	
A	0.216	0.226	5.48	5.74	
B	0.176	0.182	4.48	4.63	
C	0.094	0.100	2.40	2.55	
D	0.170	0.176	4.33	4.48	
E	0.039	0.055	1.00	1.40	
F	0.060	0.081	2.03	2.07	
G	0.068	0.083	1.72	2.10	
H	0.112	0.118	2.85	3.00	
J	0.057	-	1.44	-	
K	-	0.018	-	0.45	
L	0.016	-	0.40	-	
M	0.109	0.115	2.77	2.93	
N	0.105	0.107	2.67	2.73	
P	0.078	0.081	2.00	2.05	

### Maximum Ratings and Electrical Characteristics

Ratings at 25°C ambient temperature unless otherwise specified.

Resistive or inductive load.

For capacitive load, derate current by 20%.

	Symbols	SRN3	SRN4	SRN5	SRN6	SRN7	Units
Maximum repetitive peak reverse voltage	$V_{RRM}$	50	100	200	400	600	Volts
Maximum RMS voltage	$V_{RMS}$	35	70	140	280	420	Volts
Maximum DC blocking voltage	$V_{DC}$	50	100	200	400	600	Volts
Maximum average forward rectified current at $T_c=90^\circ\text{C}$	$I_{(AV)}$	1.0					Amp
Peak forward surge current 8.3mS single half sine-wave superimposed on rated load (MIL-STD-750D 4066 method)	$I_{FSM}$	30.0					Amps
Maximum instantaneous forward voltage at 1.0A	$V_F$	1.3					Volts
Maximum DC reverse current at rated DC blocking voltage $T_A=25^\circ\text{C}$ $T_A=125^\circ\text{C}$	$I_R$	5.0 300.0					$\mu\text{A}$
Maximum reverse recovery time (Note 1) $T_J=25^\circ\text{C}$	$T_{rr}$	150			250	500	nS
Typical junction capacitance (Note 2)	$C_J$	10.0					$\mu\text{F}$
Maximum thermal resistance (Note 3)	$R_{\theta JL}$	30.0					$^\circ\text{C/W}$
Operating and storage temperature range	$T_J, T_{STG}$	-50 to +150					$^\circ\text{C}$

Notes:

- (1) Reverse recovery test conditions:  $I_F=0.5\text{A}$ ,  $I_R=1.0\text{A}$ ,  $I_{rr}=0.25\text{A}$
- (2) Measured at 1.0MHz and applied reverse voltage of 4.0 volts
- (3) 8.0mm<sup>2</sup> (0.013mm thick) land areas

# RATINGS AND CHARACTERISTIC CURVES

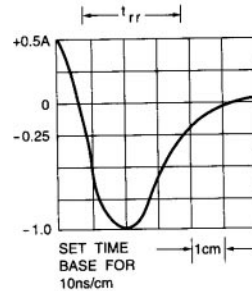
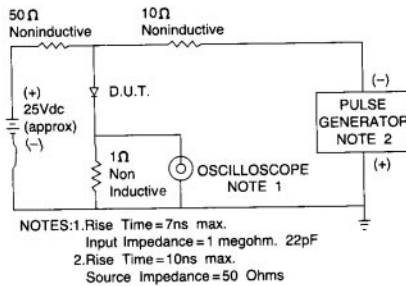
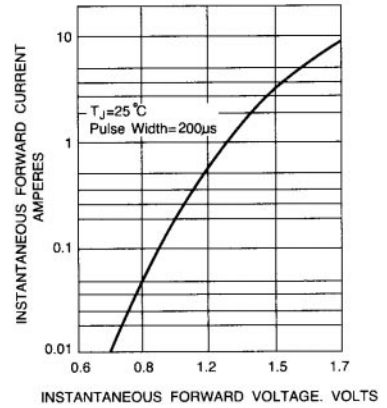
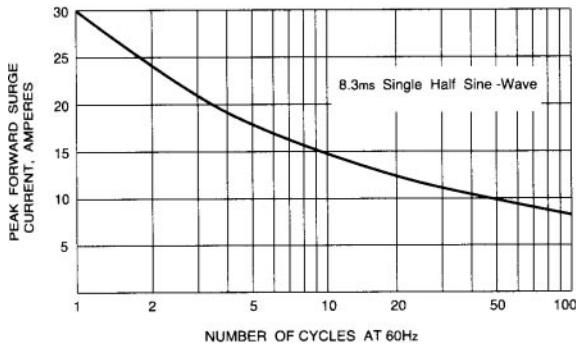
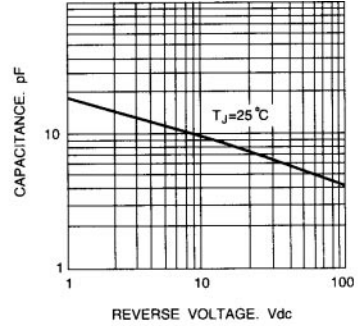
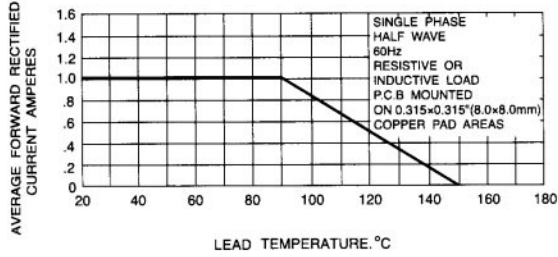

Fig. 5-REVERSE RECOVERY TIME CHARACTERISTIC AND TEST CIRCUIT DIAGRAM