



STANDARD
MICROSYSTEMS
CORPORATION

USB97C201
Rev 1.6



USB 2.0 ATA/ ATAPI Controller

FEATURES

- 2.5 Volt, Low Power Core Operation
- 3.3 Volt I/O with 5V input tolerance
- Complete USB Specification 2.0 Compatibility
 - Includes USB 2.0 Transceiver
 - A Bi-directional Control, a Bi-directional Interrupt, and a Bi-directional Bulk Endpoint are provided.
- Complete System Solution for interfacing ATA or ATAPI devices to USB 2.0 bus
 - Supports USB Mass Storage Compliant Bootable BIOS
 - Support for ATAPI Devices:
 - CD-ROM
 - CD-R
 - CD-RW
 - DVD
 - DVD/R/W
- 8051 8 bit microprocessor
 - Provides low speed control functions
 - 30 Mhz execution speed at 4 cycles per instruction average
 - 768 Bytes of internal SRAM for general purpose scratchpad or program execution while re-flashing external ROM
- Double Buffered Bulk Endpoint
 - Bi-directional 512 Byte Buffer for Bulk Endpoint
 - 64 Byte RX Control Endpoint Buffer
 - 64 Byte TX Control Endpoint Buffer
 - 64 Byte TX Interrupt Endpoint Buffer
 - 64 Byte RX Interrupt Endpoint Buffer
- External Program Memory Interface
 - 64K Byte Code Space
 - Flash, SRAM, or EPROM Memory
- On Board 12Mhz Crystal Driver Circuit
- Internal PLL for 480Mhz USB2.0 Sampling, 30Mhz MCU clock, and 60Mhz ATA clock
- Supports firmware upgrade via USB bus if “boot block” Flash program memory is used
- 8 GPIOs for special function use : LED indicators, button inputs, etc.
 - Inputs capable of generating interrupts with either edge sensitivity
 - One GPIO has automatic ½ sec toggle capability for flashing an LED indicator.
- 100 Pin TQFP Package (14.0 x 14.0 mm footprint)
 - 25% smaller body size than other 100 pin TQFP Packages
- 100 Pin QFP Package

ORDERING INFORMATION

Order Number(s):

USB97C201-MN
for 100 pin TQFP package

USB97C201-MC
for 100 pin QFP package

© STANDARD MICROSYSTEMS CORPORATION (SMSC) 2003



80 Arkay Drive
Hauppauge, NY 11788
(631) 435-6000
FAX (631) 273-3123

Standard Microsystems and SMSC are registered trademarks of Standard Microsystems Corporation. Product names and company names are the trademarks of their respective holders. Circuit diagrams utilizing SMSC products are included as a means of illustrating typical applications; consequently complete information sufficient for construction purposes is not necessarily given. Although the information has been checked and is believed to be accurate, no responsibility is assumed for inaccuracies. SMSC reserves the right to make changes to specifications and product descriptions at any time without notice. Contact your local SMSC sales office to obtain the latest specifications before placing your product order. The provision of this information does not convey to the purchaser of the semiconductor devices described any licenses under the patent rights of SMSC or others. All sales are expressly conditional on your agreement to the terms and conditions of the most recently dated version of SMSC's standard Terms of Sale Agreement dated before the date of your order (the "Terms of Sale Agreement"). The product may contain design defects or errors known as anomalies which may cause the product's functions to deviate from published specifications. Anomaly sheets are available upon request. SMSC products are not designed, intended, authorized or warranted for use in any life support or other application where product failure could cause or contribute to personal injury or severe property damage. Any and all such uses without prior written approval of an Officer of SMSC and further testing and/or modification will be fully at the risk of the customer. Copies of this document or other SMSC literature, as well as the Terms of Sale Agreement, may be obtained by visiting SMSC's website at <http://www.smisc.com>.

SMSC DISCLAIMS AND EXCLUDES ANY AND ALL WARRANTIES, INCLUDING WITHOUT LIMITATION ANY AND ALL IMPLIED WARRANTIES OF MERCHANTABILITY, FITNESS FOR A PARTICULAR PURPOSE, TITLE, AND AGAINST INFRINGEMENT AND THE LIKE, AND ANY AND ALL WARRANTIES ARISING FROM ANY COURSE OF DEALING OR USAGE OF TRADE.

IN NO EVENT SHALL SMSC BE LIABLE FOR ANY DIRECT, INCIDENTAL, INDIRECT, SPECIAL, PUNITIVE, OR CONSEQUENTIAL DAMAGES, OR FOR LOST DATA, PROFITS, SAVINGS OR REVENUES OF ANY KIND; REGARDLESS OF THE FORM OF ACTION, WHETHER BASED ON CONTRACT, TORT, NEGLIGENCE OF SMSC OR OTHERS, STRICT LIABILITY, BREACH OF WARRANTY, OR OTHERWISE; WHETHER OR NOT ANY REMEDY IS HELD TO HAVE FAILED OF ITS ESSENTIAL PURPOSE; AND WHETHER OR NOT SMSC HAS BEEN ADVISED OF THE POSSIBILITY OF SUCH DAMAGES.

TABLE OF CONTENTS

1.0	GENERAL DESCRIPTION	6
2.0	PIN TABLE	7
3.0	PIN CONFIGURATION	8
3.1	QFP/TQFP 100 Pin	8
4.0	BLOCK DIAGRAM	9
5.0	PIN DESCRIPTIONS	10
5.1	BUFFER TYPE DESCRIPTIONS	13
6.0	FUNCTIONAL BLOCK DESCRIPTIONS	14
6.1	MCU	14
6.1.1	MCU Memory Map: Code Space	14
6.1.2	MCU Memory Map: XData Space	15
6.1.3	MCU Block Register Summary	16
6.1.4	MCU Register Descriptions	19
6.2	SIE Block	42
6.2.1	Autonomous USB Protocol	43
6.2.2	USB Events	43
6.2.3	Standard Device Requests	44
6.2.4	SIE Configurations	44
6.3	IDE Controller Description	45
6.3.1	IDE Configurations	45
6.3.2	PIO IDE Operations	45
6.3.3	PIO IDE Data Prefetching and Posting	46
6.3.4	DMA Transfers	46
6.3.5	Ultra ATA/66 Synchronous DMA Operation	46
6.3.6	Ultra ATA/66 Operation	47
6.4	SRAM Buffers	48
6.5	8051 Options	48
6.6	Address Multiplexing	48
6.7	SRAM Time Multiplexer Operation	49
6.7.1	Phase 0 (Ø0)	49
6.7.2	Phase 1 (Ø1)	49
6.7.3	Phase 2 (Ø2)	49
6.7.4	Phase 3 (Ø3)	50
6.8	EP2 SRAM Buffer Operation	50
6.9	EP2 Automatic Buffer Operations	50
6.9.1	Receive Auto-Toggle	50
6.9.2	Transmit Buffer Operation	52
6.9.3	Automatic Transfer Operation	52
7.0	DC PARAMETERS	54
8.0	AC SPECIFICATIONS	56
8.1	ATA/ATAPI	56
8.2	USB2.0 Timing	56
9.0	PACKAGING	57
10.0	USB97C201 REVISIONS	59

TABLES

Table 1 - USB97C201 Buffer Type Descriptions	13
Table 2 - MCU Code Memory Map	14
Table 3 - MCU XData Memory Map	15
Table 4 - MCU Block Register Summary.....	16
Table 5 - 8051 Core SFR Register Summary.....	18
Table 6 - Interrupt 0 Source Register	19
Table 7 - Interrupt 0 Mask	20
Table 8 - Interrupt 1 Source Register	20
Table 9 - Interrupt 1 Mask	21
Table 10 - Device Revision Register	21
Table 11 - Device Identification Register.....	21
Table 12 - GPIO Direction Register.....	22
Table 13 - GPIO Output Register	24
Table 14 - GPIO Input Register.....	24
Table 15 - GPIO Interrupt Status Register (INT4)	24
Table 16 - GPIO Interrupt Mask Register	25
Table 17 - Utility Configuration Register.....	26
Table 18 - SRAM Data Port Register	26
Table 19 - SRAM Address Register 1	27
Table 20 - SRAM Address Register 2	27
Table 21 - MCU Clock Source Select.....	27
Table 22 - Wakeup Source 1 Register (INT2)	28
Table 23 - Wakeup Mask 1 Register	28
Table 24 - USB Address Register	29
Table 25 - SIE Configuration Register	29
Table 26 - USB Bus Status Register	30
Table 27 - USB Bus Status Mask Register.....	30
Table 28 - SIE Status Register	31
Table 29 - SIE Status Mask Register	31
Table 30 - USB Configuration Number Register.....	32
Table 31 - Endpoint 0 Receive Control Register	32
Table 32 - Endpoint 0 Transmit Control Register	32
Table 33 - Endpoint 1 Receive Control Register	32
Table 34 - Endpoint 1 Transmit Control Register	33
Table 35 - Endpoint 2 Control Register	33
Table 36 - Endpoint 0 Receive Byte Count Register	34
Table 37 - Endpoint 0 Transmit Byte Count Register	35
Table 38 - Endpoint 1 Receive Byte Count Register	35
Table 39 - Endpoint 1 Transmit Byte Count Register	35
Table 40 - RAM Buffer Write Byte Count Register A1	35
Table 41 - RAM BUFFER WRITE Byte Count Register A2 Register.....	35
Table 42 - RAM Buffer Write Byte Count Register B1	36
Table 43 - RAM Buffer Write Byte Count Register B2 Register	36
Table 44 - RAM Buffer Read Byte Count Register A1	36
Table 45 - RAM Buffer Read Byte Count Register A2 Register.....	36
Table 46 - RAM Buffer Read Byte Count Register B1	36
Table 47 - RAM Buffer Read Byte Count Register B2 Register.....	36
Table 48 - NAK Register (INT5)	36
Table 49 - NAK Mask Register	37
Table 50 - USB Error Register.....	37
Table 51 - MSB ATA Data Register.....	38
Table 52 - LSB ATA Data Register.....	38
Table 53 - ATA Transfer Count Register 0	38
Table 54 - ATA Transfer Count Register 1	38
Table 55 - ATA Transfer Count Register 2	38
Table 56 - ATA Transfer Count Register 3	39
Table 57 - ATA Control Register	39
Table 58 - ATA Ultra DMA Timing Register.....	40
Table 59 - IDE Timing Register	40
Table 60 - ATA Slew Rate Control A Register.....	42
Table 61 - ATA Slew Rate Control B Register.....	42
Table 62 - IDE Transaction Timing.....	46
Table 63 - ULTRA ATA/66 Control Signal Assignments.....	47
Table 64 - Buffer SRAM Mapping.....	48

Table 65 – RAMWR_TOGGLE State Control 51

FIGURES

Figure 1 - MCU to EXTERNAL CODE SPACE MAP 14
Figure 2 - GPIO MUXING BLOCK DIAGRAM 23
Figure 3 - RECEIVE BUFFER OPERATION 51
Figure 4 - TRANSMIT BUFFER OPERATION 52
Figure 5 - AUTOMATIC DATA TRANSFER OPERATION 53
Figure 6 - 100 PIN TQFP PACKAGE 57
Figure 7 – 100 PIN QFP PACKAGE 58

1.0 GENERAL DESCRIPTION

The USB97C201 is a USB2.0 Mass Storage Class Peripheral Controller intended for use with standard ATA hard drives and standard ATAPI-5 devices.

The device consists of a USB 2.0 PHY and SIE, buffers, Fast 8051 microprocessor with expanded scratchpad and 768 of program SRAM, and an ATA-66 compatible interface.

Provisions for external Flash Memory up to 64K bytes for program storage is provided.

Internal 768 Bytes of program SRAM are also provided.. This internal SRAM is used for program storage to implement program upgrade via USB download to "boot block" Flash program memory, if desired.

Eight GPIO pins are provided for controlling external power control elements and sensing specialized drive functions. Provisions are made to allow dynamic attach and re-attach to the USB bus to allow hot swap of drives to be implemented.

2.0 PIN TABLE

DISK DRIVE INTERFACE (27 Pins)			
IDE_D0	IDE_D1	IDE_D2	IDE_D3
IDE_D4	IDE_D5	IDE_D6	IDE_D7
IDE_D8	IDE_D9	IDE_D10	IDE_D11
IDE_D12	IDE_D13	IDE_D14	IDE_D15
IDE_nIOR	IDE_nIOW	IDE_IRQ	IDE_DACK
IDE_DRQ	IDE_nCS0	IDE_nCS1	IDE_SA0
IDE_SA1	IDE_SA2	IORDY	
USB INTERFACE (7 Pins)			
USB+	USB-	LOOPFLTR	RBIAS
RTERM	FS+	FS-	
MEMORY/IO INTERFACE (28 Pins)			
MD0	MD1	MD2	MD3
MD4	MD5	MD6	MD7
MA0	MA1	MA2	MA3
MA4	MA5	MA6	MA7
MA8	MA9	MA10	MA11
MA12	MA13	MA14	MA15
nMRD	nIOR	nMWR	nIOW
MISC (15 Pins)			
GPIO0	GPIO1	GPIO2	GPIO3
GPIO4/nWE	GPIO5	GPIO6	GPIO7
XTAL1/CLKIN	XTAL2	nRESET	nTEST/nDBGSTR
TST_OUT/DBGOUT	nTESTEN	CLKOUT	
POWER, GROUNDS, and NO CONNECTS (23 Pins)			

3.0 PIN CONFIGURATION

3.1 QFP/TQFP 100 Pin

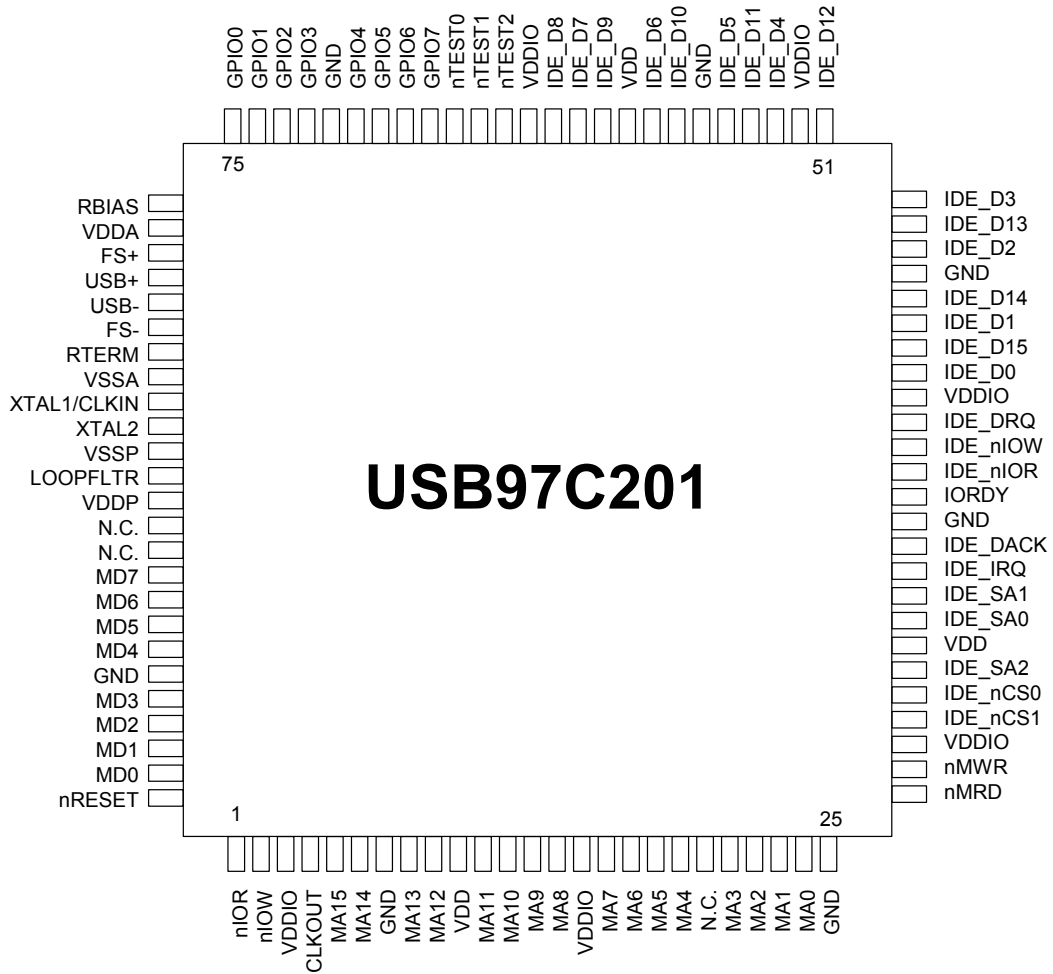

4.0 BLOCK DIAGRAM

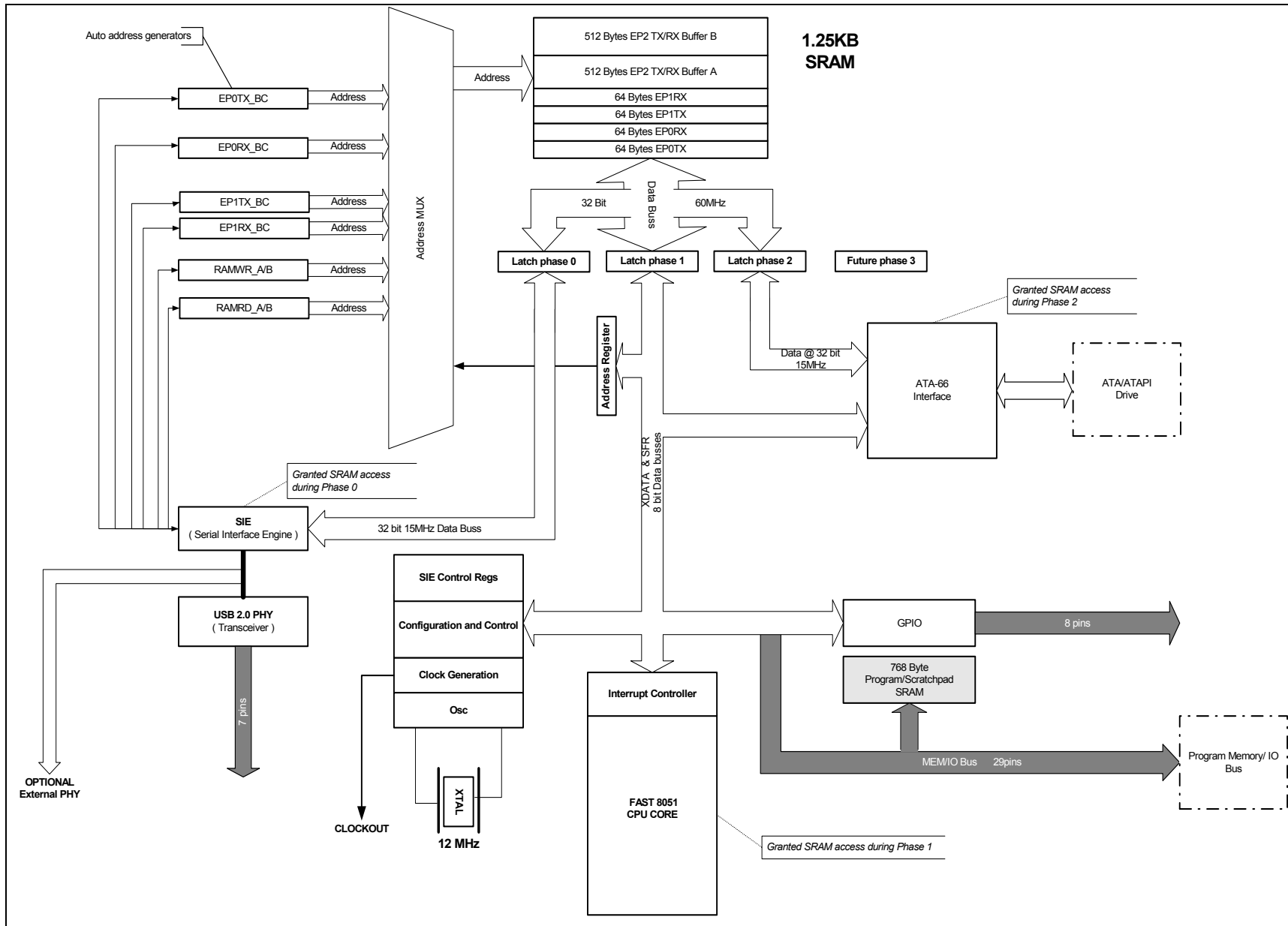

5.0 PIN DESCRIPTIONS

DISK DRIVE INTERFACE			
IDE DMA Request	IDE_DRQ	IS	This pin is the active high DMA request from the ATA/ATAPI interface.
IDE IO Read Strobe	IDE_nIOR	O20	This pin is the active low read signal for the interface.
IDE Register Address 1	IDE_SA1	O20	This pin is the register select address bit 1 signal for the ATA/ATAPI interface.
IDE Register Address 0	IDE_SA0	O20	This pin is the register select address bit 0 signal for the ATA/ATAPI interface.
IDE Register Address 2	IDE_SA2	O20	This pin is the register select address bit 2 signal for the ATA/ATAPI interface.
IDE Data	IDE_D15	IO20	This pin is the bi-directional data bus bit 15 signal for the ATA/ATAPI interface.
IDE IO Write Strobe	IDE_nIOW	O20	This pin is active low write signal for the ATA/ATAPI interface.
IDE DMA Acknowledge	IDE_nDACK	O20	This pin is the active low DMA acknowledge signal for the ATA/ATAPI interface.
IDE Interrupt Request	IDE_IRQ	IS	This pin is the active high interrupt request signal for the ATA/ATAPI interface.
IDE Data	IDE_D13	IO20	This pin is the bi-directional data bus bit 13 signal for the ATA/ATAPI interface.
IDE Data	IDE_D14	IO20	This pin is the bi-directional data bus bit 14 signal for the ATA/ATAPI interface.
IDE Chip Select 0	IDE_nCS0	O20	This pin is the active low chip select 0 signal for the ATA/ATAPI interface.
IDE Chip Select 1 0	IDE_nCS1	O20	This pin is the active low select 1 signal for the ATA/ATAPI interface.
IDE Data	IDE_D[0:12]	IO20	These pins are bits 0-12 of the ATA/ATAPI bi-directional data bus.
IO Ready	IORDY	I	This pin is the active high IORDY signal from the IDE drive.

USB INTERFACE			
USB Bus Data	USB- USB+	IO-U	These pins connect to the USB bus data signals.
USB Transceiver Filter	LOOPFLTR		This pin provides the ability to supplement the internal filtering of the transceiver with an external network, if required.
USB Transceiver Bias	RBIAS		A 9.09 Kohm precision resistor is attached from ground to this pin to set the transceiver's internal bias currents.
Termination Resistor	RTERM		A precision 1.5Kohm precision resistor is attached to this pin from a 3.3V supply.
Full Speed USB Data	FS- FS+	IO-U	These pins connect to the USB- and USB+ pins through 31.6 ohm series resistors.

MEMORY/IO INTERFACE			
Memory Data Bus	MD[7:0]	IO12	These signals are used to transfer data between the internal CPU and the external program memory.
Memory Address Bus	MA[15:0]	O12	These signals address memory locations within the external memory.
Memory Write Strobe	nMWR	O12	Program Memory Write; active low
Memory Read Strobe	nMRD	O12	Program Memory Read; active low
IO Read Strobe	nIOR	O12	XDATA space Read; active low
IO Write Strobe	nIOW	O12	XDATA space Write; active low

MISC			
Crystal Input/External Clock Input	XTAL1/CLKIN	ICLKx	12Mhz Crystal or external clock input. This pin can be connected to one terminal of the crystal or can be connected to an external 12Mhz clock when a crystal is not used.
Crystal Output	XTAL2	OCLKx	12Mhz Crystal This is the other terminal of the crystal, or left open when an external clock source is used to drive XTAL1/CLKIN. It may not be used to drive any external circuitry other than the crystal circuit.
Clock Output	CLKOUT	O8	This pin produces a 30Mhz clock signal independent of the processor clock divider. It is held inactive and low whenever the internal processor clock is stopped or is being obtained from the ring oscillator.
General Purpose I/O	GPIO[0:7]	IO20	These general purpose pins may be used either as inputs, edge sensitive interrupt inputs, or outputs. In addition, GPIO0 has the capability of auto-toggling at a 1Hz rate when used as an output.
RESET input	nRESET	IS	This active low signal is used by the system to reset the chip. The active low pulse should be at least 100ns wide.
Test input	nTest{0:2}	IP	These signals are used for testing the chip. User should normally leave them unconnected. For board testing, all pads except these test inputs are included in an XNOR chain, such that by tying nTEST2 low, nIOR will reflect the toggling of a signal on each pin. Circuit board continuity of the pin solder connections after assembly can be checked in this manner
POWER, GROUNDS, and NO CONNECTS			
	VDD		+2.5V Core power
	VDDIO		+3.3V I/O power
	VDDP		+2.5 Analog power
	VSSP		Analog Ground Reference
	VDDA		+3.3V Analog power
	VSSA		Analog Ground Reference
	GND		Ground Reference
	NC		No Connect. These pins should not be connected externally.

5.1 BUFFER TYPE DESCRIPTIONS

Table 1 - USB97C201 Buffer Type Descriptions

BUFFER	DESCRIPTION
I	Input
IS	Input with Schmitt trigger
IO8	Input/Output with 8 mA drive
O8	Output with 8mA drive
O12	Output with 12mA drive
IO20	Input/output with 20mA drive
OD12	Open drain....12mA sink
O20	Output with 20mA drive
ICLKx	XTAL clock input
OCLKx	XTAL clock output
I/O-U	Defined in USB specification

6.0 FUNCTIONAL BLOCK DESCRIPTIONS

6.1 MCU

The 64K memory map is as follows from the 8051's viewpoint:

6.1.1 MCU MEMORY MAP: CODE SPACE

The 8051 has a single flat 64K Code space. External memory requires *80ns* access times from Address to Data and less than *80ns* output enable access times, assuming the use of the nMEMR signal as OE on the memory.

Table 2 - MCU Code Memory Map

8051 ADDRESS	CODE SPACE	ACCESS
0x0700-0xFFFF	Fixed Memory	External Program Memory
0x0400-0x06FF	768 Bytes of Fixed 16k FLASH Page OR 768 Bytes of Internal SRAM for program execution (see bit 7 of the UTIL_CFG register for more information)	External Program Memory OR Internal Program SRAM
0x0000-0x03FF	Fixed Memory	External Program Memory

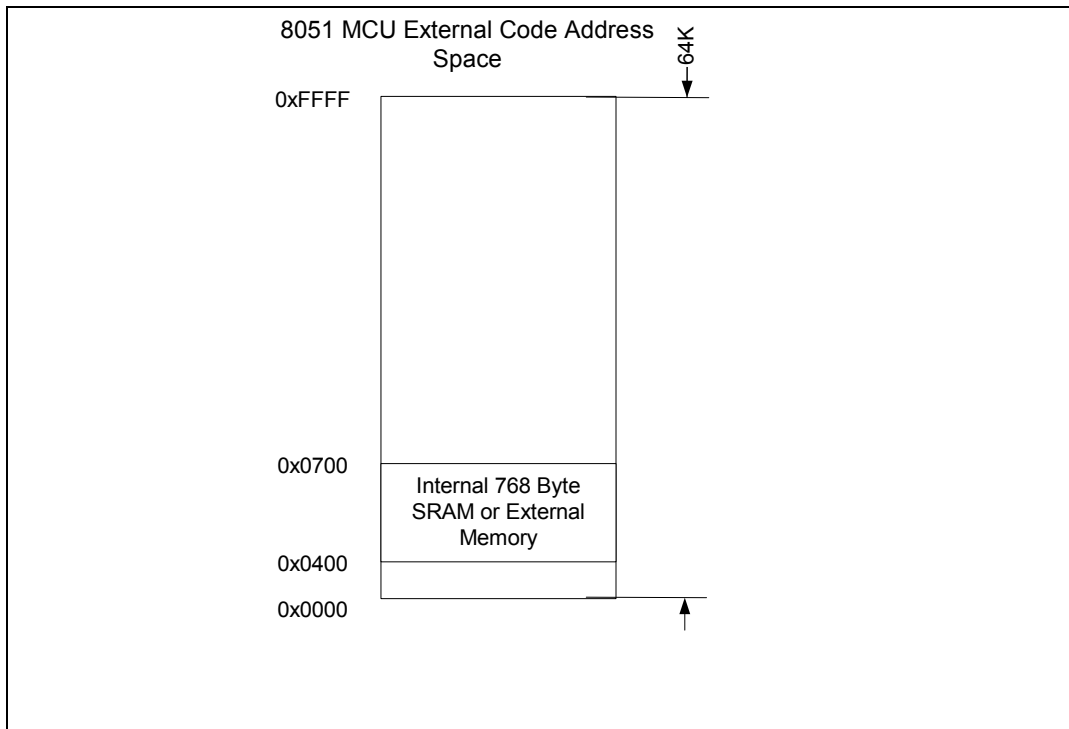

FIGURE 1 - MCU TO EXTERNAL CODE SPACE MAP

6.1.2 MCU MEMORY MAP: XDATA SPACE

Table 3 - MCU XData Memory Map

8051 ADDRESS	DATA SPACE	ACCESS
0x3F30-0xFFFF	External Memory or I/O Devices	External (IOR or IOW active)
0x3F00-0x3F2F	Internal Test Registers (reserved access)	DO NOT ACCESS
0x33F7-0X3EFF	External Memory or I/O Devices	External (IOR or IOW active)
033F6	External ATA Interface I/O	External (IOR or IOW active)
0x31F8-0x33F5	External Memory or I/O Devices	External (IOR or IOW active)
0x31F0-0x31F7	External ATA Interface I/O	External (IOR or IOW active)
0x30F4-0x31EF	External Memory or I/O Devices	External (IOR or IOW active)
0X30F0-0X30F3	Internal Test Registers (reserved access)	DO NOT ACCESS
0X0700-0X30EF	External Memory or I/O Devices	External (IOR or IOW active)
0x0400-0x06FF	768 Byte SRAM	Internal
0x0000-0x03FF	(see Note 1)	External (IOR or IOW active)(see Note 1)

Note 1: This XDATA space is accessed using MOVX instructions. A region of 8051 Special Function Registers (SFR) is also accessible at 0x0100 to 0x01FF addresses using the MOV instructions. In addition to the normal 8051 SFRs, there are also numerous Runtime Registers in this SFR space. These Runtime Registers are external to the 8051, but internal to the USB97C201.

6.1.3 MCU BLOCK REGISTER SUMMARY

Table 4 - MCU Block Register Summary
(These registers are external to the 8051 design core)

ADDRESS	NAME	R/W	DESCRIPTION	PAGE
RUNTIME REGISTERS				
80	ISR_0	R/W	INT0 Source Register	19
93	IMR_0	R/W	INT0 Mask Register	20
90	ISR_1	R/W	INT1 Source Register	20
94	IMR_1	R/W	INT1 Mask Register	21
95	DEV_REV	R	Device Revision Register	21
96	DEV_ID	R	Device ID Register	21
UTILITY REGISTERS				
97	GPIO_DIR	R/W	GPIO Direction Register	22
9A	GPIO_OUT	R/W	GPIO Data Output Register	24
9B	GPIO_IN	R	GPIO Data Input Register	24
C0	GPIO_IRQ	R/W	GPIO Interrupt Status Register (INT4)	24
9C	GPIO_MSK	R/W	GPIO Interrupt Mask Register (INT4)	25
9D	UTIL_CONFIG	R/W	Miscellaneous Configuration Register	26
9F	SRAM_DATA	R/W	SRAM Data Port Register	26
A1	SRAM_ADD1	R/W	SRAM Address 1 Register	27
A2	SRAM_ADD2	R/W	SRAM Address 2 Register	27
POWER MANAGEMENT REGISTERS				
A5	CLOCK_SEL	R/W	8051 Clock Select Register	27
A0	WU_SRC_1	R/W	Wakeup Source 1 Register (INT2)	28
A6	WU_MSK_1	R/W	Wakeup Mask 1 Register (INT2)	28

SIE & BUFFER CONTROL REGISTERS				
A9	USB_ADD	R/W	USB Address Register	29
AA	SIE_CONF	R/W	SIE Configuration Register	29
AB	USB_STAT	R/W	USB Bus Status Register	30
AC	USB_MSK	R/W	USB Bus Status Mask Register	30
B0	SIE_STAT	R	SIE Status Register	31
AD	USB_CONF	R/W	USB Configuration Number Register	32
AE	SIE_MSK	R/W	SIE Status Mask Register	31
AF	EP0RX_CTL	R/W	Endpoint 0 Receive Control Register	32
B1	EP0TX_CTL	R/W	Endpoint 0 Transmit Control Register	32
B2	EP1RX_CTL	R/W	Endpoint 1 Receive Control Register	32
B3	EP1TX_CTL	R/W	Endpoint 1 Transmit Control Register	33
B4	EP2_CTL	R/W	Endpoint 2 Control Register	33
B5	EP0RX_BC	R/W	Endpoint 0 Receive Byte Count Register	34
B6	EP0TX_BC	R/W	Endpoint 0 Transmit Byte Count Register	35
B7	EP1RX_BC	R/W	Endpoint 1 Receive Byte Count Register	35
C7	EP1TX_BC	R/W	Endpoint 1 Transmit Byte Count Register	35
CE	RAMWRBC_A1	R/W	RAM Buffer Write Byte Count Register A1	35
CF	RAMWRBC_A2	R/W	RAM Buffer Write Byte Count Register A2	35
D1	RAMWRBC_B1	R/W	RAM Buffer Write Byte Count Register B1	36
D2	RAMWRBC_B2	R/W	RAM Buffer Write Byte Count Register B2	36
D3	RAMRDBC_A1	R/W	RAM Buffer Read Byte Count Register A1	36
D4	RAMRDBC_A2	R/W	RAM Buffer Read Byte Count Register A2	36
D5	RAMRDBC_B1	R/W	RAM Buffer Read Byte Count Register B1	36
D6	RAMRDBC_B2	R/W	RAM Buffer Read Byte Count Register B2	36
D7	NAK	R/W	NAK Status Register	36
D9	NAK_MSK	R/W	NAK Mask Register	37
DA	USB_ERR	R	USB Error Register	39
ATA CONFIGURATION REGISTERS				
DB	MSB_ATA	R/W	MSB ATA Data Register	38
DC	LSB_ATA	R/W	LSB ATA Data Register	38
DD	ATA_CTL	R/W	ATA Control Register	39
DE	ATA_DMA	R/W	ATA Ultra DMA Timing Register	40
DF	IDE_TIM	R/W	IDE Timing Register	40
E1	ATA_CNT0	R/W	ATA Transfer Count Register 0	38
E2	ATA_CNT1	R/W	ATA Transfer Count Register 1	38
E3	ATA_CNT2	R/W	ATA Transfer Count Register 2	38
E4	ATA_CNT3	R/W	ATA Transfer Count Register 3	39
E5	ATA_SRCA	R/W	ATA Slew Rate Control A Register	42
E6	ATA_SRCB	R/W	ATA Slew Rate Control B Register	42

Table 5 - 8051 Core SFR Register Summary

These registers are part of the 8051 design core itself.

REGISTER	BIT7	BIT6	BIT5	BIT4	BIT3	BIT2	BIT1	BIT0	ADDRESS
SP									81h
DPL0									82h
DPH0									83h
DPL1									84h
DPH1									85h
DPS	0	0	0	0	0	0	0	SEL	86h
PCON	SMOD0	–	1	1	GF1	GF0	STOP	IDLE	87h
TCON	TF1	TR1	TF0	TR0	IE1	IT1	IE0	IT0	88h
TMOD	GATE	C/T	M1	M0	GATE	C/T	M1	M0	89h
TL0									8Ah
TL1									8Bh
TH0									8Ch
TH1									8Dh
CKCON			T2M	T1M	T0M	MD2	MD1	MD0	8Eh
SPC_FNC	0	0	0	0	0	0	0	WRS	8Fh
EXIF	IE5	IE4	IE3	IE2	1	0	0	0	91h
MPAGE									92h
SCON0	SM0_0	SM1_0	SM2_0	REN_0	TB8_0	RB8_0	TI_0	RI_0	98h
SBUF0									99h
IE	EA	ES1	ET2	ES0	ET1	EX1	ET0	EX0	A8h
IP	1	PS1	PT2	PS0	PT1	PX1	PT0	PX0	B8h
TL2									CCh
TH2									CDh
PSW	CY	AC	F0	RS1	RS0	OV	F1	P	D0h
EICON	SMOD1	1	EPFI	PFI	WDTI	0	0	0	D8h
ACC									E0h
EIE	1	1	1	EWDI	EX5	EX4	EX3	EX2	E8h
B									F0h
EIP	1	1	1	PWDI	PX5	PX4	PX3	PX2	F8h

Notes:

- Bit WRS of the SPC_FNC register controls the operation of MOVX writes the program or XDATA bus of the 8051. Setting it to 0 (the reset state), will direct writes to the XDATA bus, either to internal or external destinations, while setting it to 1 will allow writes to the program memory bus to occur, either internally(if the 768 SRAM is the target) or externally.
- Bits MD2:0 of the CKCON SFR register (8Eh) control the cycle timing for external accesses using the nIOR and nIOW signals. This allows slow peripheral devices to be attached. The values and corresponding strobe widths are shown below:

MD2	MD1	MD0	NIOR/NIOW STROBE (CLKS)	NIOR/NIOW STROBE (AT 30MHZ)
0	0	0	2	66ns
0	0	1	4	133ns
0	1	0	8	267ns
0	1	1	12	400ns
1	0	0	16	533ns
1	0	1	20	667ns
1	1	0	24	800ns
1	1	1	28	933ns

Note: the strobe width will vary with the actual clock divider used for the processor. For example if, 16 Mhz is used, an MD[2:0] value of 111 will result in a 28 clock strobe or 1866ns.

6.1.4 MCU REGISTER DESCRIPTIONS

6.1.4.1 MCU Runtime Registers

Table 6 - Interrupt 0 Source Register

ISR_0 (0x80 - RESET=0x0C)			INTERRUPT 0 SOURCE REGISTER
BIT	NAME	R/W	DESCRIPTION
7	USB_STAT	R	1= USB Bus System Event has occurred. Check USB_STAT register for the specific event(s). This must be cleared by clearing the USB_STAT register.
6	SETUP	R/W	1= A SETUP packet was received on Endpoint 0. The EP0RX bit of ISR_1 will not be set. If another SETUP packet is received on Endpoint 0 while this bit is high, the bit will go low and then immediately high again, to signal the duplicate SETUP. If all other bits in this register are clear and the INTO of the 8051 is configured for edge triggering, then another interrupt will be generated within the 8051. The firmware must clear this bit by writing a "1" to it to allow the Endpoint 0 buffer to receive subsequent data packets during the SETUP transaction. Receipt of these packets will set EP0RX in ISR_1.
5	Reserved	R	This bit always reads a "0".
4	ATA_IRQ	R/W	External interrupt input from the ATA-66 Interface. 1 = An ATA interrupt has occurred.
3	RAMRD_B	R/W	1 = The current transfer from the SRAM B Buffer has been completed. See Sections 6.7 and 6.9 for more detail. This bit is also cleared by writing a "1" to the RAMRD_TOGGLE bit of the EP2_CTL register.
2	RAMRD_A	R/W	1 = The current transfer from the SRAM A Buffer has been completed. See Sections 6.7 and 6.9 for more detail. . This bit is also cleared by writing a "0" to the RAMRD_TOGGLE bit of the EP2_CTL register.
1	RAMWR_B	R/W	1 = The current transfer to the SRAM B Buffer has been completed. This bit may be cleared by the internal hardware state machine while operating in "Auto Transfer" mode. See Sections 6.7 and 6.9 for more detail.
0	RAMWR_A	R/W	1 = The current transfer to the SRAM A Buffer has been completed. This bit may be cleared by the internal hardware state machine while operating in "Auto Transfer" mode. See Sections 6.7 and 6.9 for more detail.

The bits in this register (except bit 7) are set to their POR values by writing a '1' to the corresponding bit. If not masked by the corresponding bit in the IMR0 mask register, a "1" on any of these bits will generate a "1" on the 8051 core's external INTO input.

Table 7 - Interrupt 0 Mask

IMR_0 (0x93- RESET=0xFF)			INTERRUPT 0 MASK REGISTER
BIT	NAME	R/W	DESCRIPTION
7	USB_STAT	R/W	USB Bus System Event interrupt mask 0 = Enable Interrupt 1 = Mask Interrupt
6	SETUP	R/W	SETUP interrupt mask 0 = Enable Interrupt 1 = Mask Interrupt
5	Reserved	R/W	Reserved.
4	ATA_IRQ	R/W	External ATA-66 interrupt input mask 0 = Enable Interrupt 1 = Mask Interrupt
3	RAMRD_B	R/W	SRAM Buffer B Output Interrupt Mask 0 = Enable Interrupt 1 = Mask Interrupt
2	RAMRD_A	R/W	SRAM Buffer A Output Interrupt Mask 0 = Enable Interrupt 1 = Mask Interrupt
1	RAMWR_B	R/W	SRAM Buffer B Input Interrupt Mask 0 = Enable Interrupt 1 = Mask Interrupt
0	RAMWR_A	R/W	SRAM Buffer A Input Interrupt Mask 0 = Enable Interrupt 1 = Mask Interrupt

Note1: The mask bits do not prevent the status in the ISR_0 register from being set, only from generating an interrupt.

Table 8 - Interrupt 1 Source Register

ISR_1 (0x90- RESET=0x00)			INTERRUPT 1 SOURCE REGISTER
BIT	NAME	R/W	DESCRIPTION
7	ZLP_EP0	R/W	1= A ZLP has been received on EP0RX.
6	Reserved	R	This bit always reads a "0".
5	ATA_PIO	R	This bit reflects that state of the PIO_COMPLETE bit (bit 6) of the ATA_CTL register. It cannot be written directly.
4	EP1RX	R/W	1 = A Packet was successfully received on Endpoint 1 and stored in the Buffer SRAM. OUT tokens will be NAK'd until this bit is cleared.
3	EP1TX	R/W	1 = A Packet was successfully transmitted on Endpoint 1 from the Buffer SRAM. IN tokens will be NAK'd until this bit is cleared.
2	EP0RX	R/W	1 = A non-SETUP, non ZLP Packet (see ISR_0 SETUP bit) was successfully received on Endpoint 0 and stored in the Buffer SRAM. OUT tokens will be NAK'd until this bit is cleared.
1	EP0TX	R/W	1 = A Packet was successfully transmitted on Endpoint 0 from the Buffer SRAM. IN tokens will be NAK'd until this bit is cleared.
0	SUSPEND	R/W	Suspend – If 3ms of IDLE state are detected by the hardware, then this bit will be set.

Note 1: The bits (except for bit 5)in this register are cleared by writing a '1' to the corresponding bit. If not masked by the corresponding bit in the IMR1 mask register, a "1" on any of these bits will generate a "1" on the 8051 core's external INT1 input.

Table 9 - Interrupt 1 Mask

IMR_1 (0x94- RESET=0xFF)			INTERRUPT 1 MASK REGISTER
BIT	NAME	R/W	DESCRIPTION
7	ZLP_EP0	R/W	Zero Length Packet Interrupt Mask 0 = Enable Interrupt 1 = Mask Interrupt
6	Resereved	R/W	Reserved. This bit should never be written to a "0".
5	ATA_PIO	R/W	ATA PIO Complete Interrupt Mask 0 = Enable Interrupt 1 = Mask Interrupt
4	EP1RX	R/W	Endpoint 1 Received Packet Interrupt Mask 0 = Enable Interrupt 1 = Mask Interrupt
3	EP1TX	R/W	Endpoint 1 Transmitted Packet Interrupt Mask 0 = Enable Interrupt 1 = Mask Interrupt
2	EP0RX	R/W	Endpoint 0 Received Packet Interrupt Mask 0 = Enable Interrupt 1 = Mask Interrupt
1	EP0TX	R/W	Endpoint 0 Transmitted Packet Interrupt Mask 0 = Enable Interrupt 1 = Mask Interrupt
0	SUSPEND	R/W	SUSPEND Interrupt Mask 0 = Enable Interrupt 1 = Mask Interrupt

Note 1: The mask bits do not prevent the status in the ISR_1 register from being set, only from generating an interrupt.

Table 10 - Device Revision Register

DEV_REV (0x95- RESET=0xFF)			DEVICE REVISION REGISTER
BIT		R/W	DESCRIPTION
[7:0]	XXh	R	This register defines additional revision information used internally by SMSC. The value is silicon revision dependent.

Table 11 - Device Identification Register

DEV_ID (0x96- RESET=0x12)			DEVICE IDENTIFICATION REGISTER
BIT		R/W	DESCRIPTION
[7:0]	12h	R	This register defines additional revision information used internally by SMSC

6.1.4.2 Utility Registers

Table 12 - GPIO Direction Register

GPIO_DIR (0x97- RESET=0x00)			GPIO DIRECTION REGISTER
BIT	NAME	R/W	DESCRIPTION
7	GPIO7	R/W	GPIO7 Direction 0 = In 1 = Out
6	GPIO6	R/W	GPIO6 Direction 0 = In 1 = Out
5	GPIO5	R/W	GPIO5 Direction 0 = In 1 = Out
4	GPIO4/nWE	R/W	GPIO4 Direction 0 = In 1 = Out
3	GPIO3/T1	R/W	GPIO3 Direction 0 = In 1 = Out
2	GPIO2/T0	R/W	GPIO2 Direction 0 = In 1 = Out
1	GPIO1/TXD	R/W	GPIO1 Direction 0 = In 1 = Out
0	GPIO0/RXD	R/W	GPIO0 Direction 0 = In 1 = Out

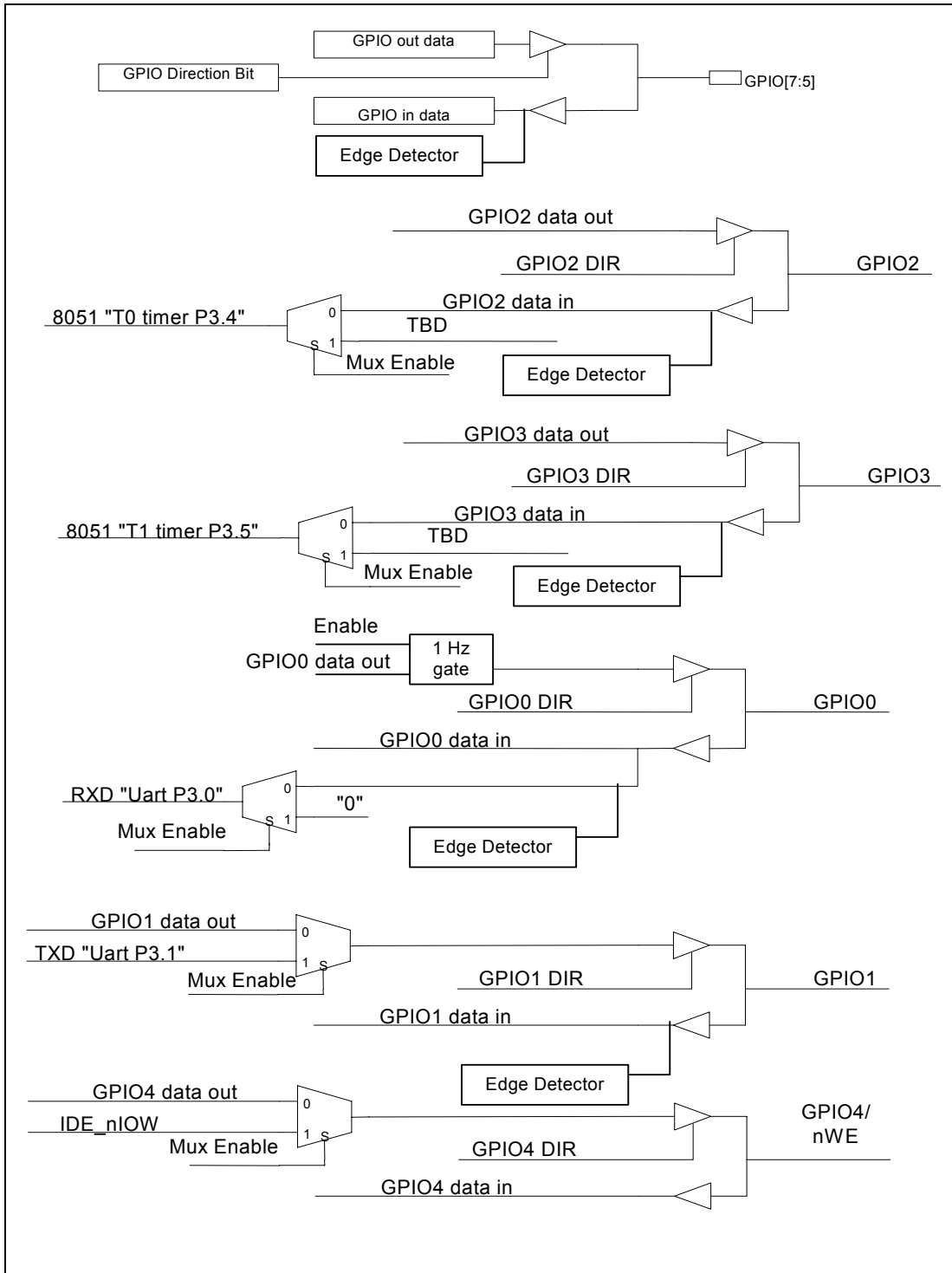

FIGURE 2 - GPIO MUXING BLOCK DIAGRAM

Table 13 - GPIO Output Register

GPIO_OUT (0x9A- RESET=0x00)			GPIO DATA OUTPUT REGISTER
BIT	NAME	R/W	DESCRIPTION
7	GPIO7	R/W	GPIO7 Output Buffer Data
6	GPIO6	R/W	GPIO6 Output Buffer Data
5	GPIO5	R/W	GPIO5 Output Buffer Data
4	GPIO4/nWE	R/W	GPIO4 Output Buffer Data
3	GPIO3/T1	R/W	GPIO3 Output Buffer Data
2	GPIO2/T0	R/W	GPIO2 Output Buffer Data
1	GPIO1/TXD	R/W	GPIO1 Output Buffer Data
0	GPIO0/RXD	R/W	GPIO0 Output Buffer Data

Table 14 - GPIO Input Register

GPIO_IN (0x9B- RESET=0x00)			GPIO INPUT REGISTER
BIT	NAME	R/W	DESCRIPTION
7	GPIO7	R	GPIO7 Input Buffer Data
6	GPIO6	R	GPIO6 Input Buffer Data
5	GPIO5	R	GPIO5 Input Buffer Data
4	GPIO4/nWE	R	GPIO4 Input Buffer Data
3	GPIO3/T1	R	GPIO3 Input Buffer Data
2	GPIO2/T0	R	GPIO2 Input Buffer Data
1	GPIO1/TXD	R	GPIO1 Input Buffer Data
0	GPIO0/RXD	R	GPIO0 Input Buffer Data

Table 15 – GPIO Interrupt Status Register (INT4)

GPIO_IRQ (0XC0- RESET=0x00)			GPIO INTERRUPT STATUS REGISTER
BIT	NAME	R/W	DESCRIPTION
7	GPIO7_IRQ	R/W	1 = A level change has occurred on GPIO7.
6	GPIO6_IRQ	R/W	1 = A level change has occurred on GPIO6.
5	GPIO5_IRQ	R/W	1 = A level change has occurred on GPIO5.
4	GPIO4_IRQ	R/W	1 = A level change has occurred on GPIO4.
3	GPIO3_IRQ	R/W	1 = A level change has occurred on GPIO3.
2	GPIO2_IRQ	R/W	1 = A level change has occurred on GPIO2.
1	GPIO1_IRQ	R/W	1 = A level change has occurred on GPIO1.
0	GPIO0_IRQ	R/W	1 = A level change has occurred on GPIO0.

Note 1: Writing a “1” (one) to a bit clears the bit and enables the detection of the next level transition. If not masked by the corresponding bit in the GPIO_MSK register, “1” in any bit in this register will force a “1” on the 8051 core’s external INT4 interrupt input.

Table 16 – GPIO Interrupt Mask Register

GPIO_MSK (0x9C- RESET=0xFF)			GPIO INTERRUPT MASK REGISTER
BIT	NAME	R/W	DESCRIPTION
7	GPIO7_MSK	R/W	1 = Prevents a high in the corresponding bit in the GPIO_IRQ register from generating an interrupt on the INT4 input to the 8051..
6	GPIO6_MSK	R/W	1 = Prevents a high in the corresponding bit in the GPIO_IRQ register from generating an interrupt on the INT4 input to the 8051..
5	GPIO5_MSK	R/W	1 = Prevents a high in the corresponding bit in the GPIO_IRQ register from generating an interrupt on the INT4 input to the 8051...
4	GPIO4_MSK	R/W	1 = Prevents a high in the corresponding bit in the GPIO_IRQ register from generating an interrupt on the INT4 input to the 8051...
3	GPIO3_MSK	R/W	1 = Prevents a high in the corresponding bit in the GPIO_IRQ register from generating an interrupt on the INT4 input to the 8051...
2	GPIO2_MSK	R/W	1 = Prevents a high in the corresponding bit in the GPIO_IRQ register from generating an interrupt on the INT4 input to the 8051...
1	GPIO1_MSK	R/W	1 = Prevents a high in the corresponding bit in the GPIO_IRQ register from generating an interrupt on the INT4 input to the 8051...
0	GPIO0_MSK	R/W	1 = Prevents a high in the corresponding bit in the GPIO_IRQ register from generating an interrupt on the INT4 input to the 8051...

Table 17 - Utility Configuration Register

UTIL_CONFIG (9D RESET=0x00)			UTILITY CONFIGURATION REGISTER
BIT	NAME	R/W	DESCRIPTION
7	SRAMSW	R/W	1 = The 768 byte SRAM is located at 0x0400-0x06FF in the Code Space, instead of external Memory. 0 = The 768 byte SRAM is located at 0x0400-0x06FF in the XDATA space.
6	Reserved	R/W	Reserved. This bit should never be written to a "1".
5	GPIO0_TOG	R/W	1 = GPIO0 Output Auto Toggle enabled. 0 = Disabled, normal operation occurs.
4	GPIO4/nWE	R/W	GPIO4/SOF Output Select Mux 0 = GPIO4 1 = The IDE_nIOW signal is output.
3	GPIO3/T1	R/W	P3.5 Timer 1 input trigger source 0 = GPIO3 1 = TBD
2	GPIO2/T0	R/W	P3.4 Timer 0 input trigger source 0 = GPIO2 1 = TBD
1	GPIO1/TXD	R/W	GPIO1/TXD Output Select Mux 0 = GPIO1 1 = P3.1
0	GPIO0/RXD	R/W	P3.0 RXD/GPIO0 Input Select Mux 0 = RXD<=GPIO0 1 = RXD<='0'

Note 1: GPIO0, when used as an output, will automatically toggle with 1second period and 50% duty cycle if GPIO0_TOG is high.

Table 18 – SRAM Data Port Register

SRAM_DATA (0x9F- RESET=0x00)			SRAM DATA PORT REGISTER
BIT	NAME	R/W	DESCRIPTION
[7:0]	SRAM_DATA [7:0]	R/W	Data to be read or written from/to the buffer SRAM. The address of the data is determined by the SRAM_ADD1/2 registers. Data to be written will be done so upon write of this register. While reads of the register always reflects the data at the memory location. Note: a delay equal to at least one NOP must exist between setting the address in the SRAM_ADDx registers and reading or writing this register. No delay is required in auto-increment operation.

Table 19 – SRAM Address Register 1

SRAM_ADD1 (A1 RESET=0x00)			SRAM ADDRESS REGISTER 1
BIT	NAME	R/W	DESCRIPTION
[7:0]	SRAM_ADD [7:0]	R/W	This register contains lower bits of the address in the buffer RAM that the SRAM_DATA register reads or writes.

Table 20 – SRAM Address Register 2

SRAM_ADD2 (0XA2- RESET=0x00)			SRAM ADDRESS REGISTER 2
BIT	NAME	R/W	DESCRIPTION
[7:3]	Reserved	R	These bits always read “0”.
[2:0]	SRAM_ADD [10:8]	R/W	This register contains upper bits of the address in the buffer RAM that the SRAM_DATA register reads or writes.

Note: These registers will auto increment upon each read or write to the SRAM_DATA register.

6.1.4.3 MCU Power Management Registers

Table 21 - MCU Clock Source Select

CLOCK_SEL (0XA5 - RESET=0x40)			MCU CLOCK SOURCE SELECT
BIT	NAME	R/W	DESCRIPTION
7	SLEEP	R/W	When PCON. 0 = 1 and SLEEP has been set to 1, the ring oscillator will be gated off, then all oscillators will be turned off for maximum power savings.
6	ROSC_EN	R/W	0 = Ring Oscillator Disable. 1 = Ring Oscillator Enable. ROSC_EN must be set to 1 before the MCU can be switched to the internal Ring Oscillator Clock source.
5	MCUCLK_SRC	R/W	MCUCLK_SRC overrides MCUCLK_x clock select and switches the MCU to the Ring Oscillator. 0 = Use Ring Oscillator. ROSC_EN must be enabled by the MCU first. 1 = Use clock specified in MCU_CLK_[1:0]
[4:3]	MCU_CLK[1:0]	R/W	[4:3] = 00: 3.75MHz [4:3] = 01: 7.5MHz [4:3] = 10: 15MHz [4:3] = 11: 30MHz
2	CLKVALID	R	Reflects the state of the PHY CLKVALID signal. When 1, indicates that the internal clocks are stable and can be used instead of the ring oscillator. After restarting the clocks with the SUSPEND bit in the SIE_CONF register, the code should wait 50us before polling this bit. This bit is polled until it reads a “1” to see if the clocks are settled before accessing any other non 8051 registers.
1:0]	Reserved	R	Always reads “0”.

Note 1: The 8051 may program itself to run off of an internal Ring Oscillator having a frequency range between 8 and 24MHz. This is not a precise clock, but is meant to provide the 8051 with a clock source, without running the 30MHz crystal oscillator or the PLL

Note 2: Switching between fast and slow clocks is recommended to save power.

Note 3: Clock switching can be done on the fly as long as both clocks are running. When switching, it takes a total of six clocks (3 clocks of the original clock plus 3 clocks of the switching clock) to guarantee the switching.

Note 4: Time TBD is required from ROOSC_EN=1 to MCUCLK_SRC=0.

Table 22 - Wakeup Source 1 Register (INT2)

WU_SRC_1 (0XA0 – RESET=0x00)			WAKEUP SOURCE 1
BIT	NAME	R/W	DESCRIPTION
[7:3]	Reserved	R/W	Reserved
2	USB_Reset	R/W	This bit is set when the SIE detects simultaneous logic lows on D+ and D- (Single-Ended 0) for 32 to 64 full speed bit times, or 4 to 8 low speed bit times (or $2.5 < t < 5.5\mu s$). The USB_Reset signal may be as long as 10ms. SETUP tokens can be NAK'd for up to 10ms after the Reset signal is released.
1	Resume	R/W	This bit is set on detection of Global Resume state (when there is a transition from the "J" state while in Global Suspend).
0	EXT_INT	R	This bit will be set if the ATA_IRQ bit of the ISR_0 register is set OR if the 8051 INT4 signal (GPIO Interrupts) is high.

Note 1: The bits 1 and 2 in this register are cleared by writing a '1' to the corresponding bit.

Note 2: Unmasked Wakeup Source bits restart the 8051 when its clock is stopped. This restarts the Ring Oscillator and crystal oscillator for the MCU to resume from $500\mu A$ operation.

Note 3: To initiate USB Remote Wakeup, the SIE_Resume bit should be used in the SIE_CONF register.

Table 23 - Wakeup Mask 1 Register

WU_MSK_1 (Note 1) (0XA6 - RESET=0xFF)			WAKEUP MASK 1
BIT	NAME	R/W	DESCRIPTION
[7:3]	Reserved	R	This bit always reads "1".
2	USB_Reset	R/W	External wakeup event. 0 = Enabled 1 = Masked
1	Resume	R/W	External wakeup event. 0 = Enabled 1 = Masked
0	EXT_INT	R/W	External wakeup event. 0 = Enabled 1 = Masked

Note 1: Interrupt events enabled by these bits are Ored and routed to the INT2 external interrupt input of the 8051 core.

6.1.4.4 SIE & Buffer Control Registers

Table 24 –USB Address Register

USB_ADD (0xA9 – RESET=0x00)			USB ADDRESS REGISTER
BIT	NAME	R/W	DESCRIPTION
7	Reserved	R	This bit always reads a “1”.
[6:0]	ADDR[6:0]	R	This is the USB bus address that the device will respond to when the EN bit is set. These bits are cleared for a USB_RESET condition. This is automatically set during enumeration by the SIE.

Table 25 – SIE Configuration Register

SIE_CONF (0xAA - RESET=0x40)			SIE CONFIGURATION REGISTER
BIT	NAME	R/W	DESCRIPTION
7	Reserved	R	This bit always reads a “0”.
6	DISCONNECT	R/W	1 = Forces the PHY to the DISCONNECT state, removing the RTERM resistor from the USB+ pin and forcing the PHY to ignore signaling on the USB bus. 0= Normal operation.
[5:4]	Reserved	R	These bits always read “0”.
3	Reserved	R/W	This bit is reserved. It must never be written to a “1”.
2	SPEED	R	1 = High speed operation, if host is capable (See USB_STAT register). 0 = Full Speed operation. <i>This bit is automatically set by the internal SIE during enumeration.</i>
1	RESUME	R/W	1 = Forces the SIE to transmit Resume Signaling (“K” State) on the line, if this capability has been enabled by the SET_FEATURE_REMOTE_WAKEUP command from the host. This bit is set by the 8051 after it wakes up from a power down state, for remote wakeup operation. The USB97C201 appropriately times the duration of this signaling in accordance with the USB specifications. This bit will not be automatically cleared at the end of the RESUME signaling. Note: In order for the USB97C201 to generate a remote wake-up, the SUSPEND bit in this register MUST be cleared (0). 0 = Normal operation
0	SUSPEND	R/W	1 = Forces the USB97C201’s PHY into power down mode for SUSPEND operation and to enable the detection of resume events and the setting of the RESUME interrupts in USB_STAT and WU_SRC_1 registers. 0 = This bit is cleared by the 8051 during wake-up operations (RESUME or Remote RESUME) to re-power the PHY and enable its clocks. Note: In order for the USB97C201 to generate a remote wake-up using bit 1 of this register, this bit MUST be cleared (0).

Note 1: If a SETUP packet is received on Endpoint 0 that is not automatically handled by the SIE (See Section 6.2.36.2.1) :

1. Any STALL conditions will be cleared for EP0.
2. An interrupt is generated, if unmasked, by the SETUP bit in the ISR_0 register.

The reception of the packet will be indicated by the SETUP bits in the ISR_0 register being set. The pid sequence is set to DATA-1 for both directions after a valid setup/DATA-0 transaction.

Table 26 - USB Bus Status Register

USB_STAT (0xAB - RESET=0x00)			USB BUS STATUS REGISTER
BIT	NAME	R/W	DESCRIPTION
[7]	Reserved	R	This bit always reads "0".
6	EP2_ERR	R/W	1 = Indicates that a token in the opposite direction inferred by the DIR bit of EP2_CTL register was received, ie an unexpected IN or OUT token.
5	2.0	R/W	1 = Host is high speed capable. This bit is set if high speed signaling is received from the host.
4	USB_RESUME	R/W	1 = Indicates that RESUME signaling has been detected. This is only valid if the USB97C201 is in the SUSPEND state via bit 0 of the SIE_CONF register.
3	USB_RESET	R/W	1 = Indicates that a USB Reset has been detected.
2	ERROR	R	1 = Indicates that a USB Error has been detected. See the USB_ERR register for details. This bit is cleared by clearing the USB_ERR register.
1	Reserved	R	This bit always reads "0".
0	Reserved	R	This bit always reads "0".

The bits in this register (except bit 2) are cleared by writing a '1' to the corresponding bit. These bits are ORed, if unMASKED in the USB_MSK register, and drive a latch for the USB_STAT bit in the ISR_0 register.

Table 27 – USB Bus Status Mask Register

USB_MSK (0xAC - RESET=0xFF)			USB BUS STATUS MASK REGISTER
BIT	NAME	R/W	DESCRIPTION
[7]	Reserved	R	This bit always reads "1".
6	EP2_ERR	R/W	1 = Prevents generation of the USB_STAT bit in the ISR_0 register when the EP2_ERR bit is set in the USB_STAT register.
5	2.0	R/W	1 = Prevents generation of the USB_STAT bit in the ISR_0 register when the 2.0 bit is set in the USB_STAT register.
4	USB_RESUME	R/W	1 = Prevents generation of the USB_STAT bit in the ISR_0 register when the USB_RESUME bit is set in the USB_STAT register.
3	USB_RESET	R/W	1 = Prevents generation of the USB_STAT bit in the ISR_0 register when the USB_RESET bit is set in the USB_STAT register.
2	ERROR	R/W	1 = Prevents generation of the USB_STAT bit in the ISR_0 register when the ERROR bit is set in the USB_STAT register.
1	Reserved	R	This bit always reads "1".
0	Reserved	R	This bit always reads "1".

Note1: The mask bits do not prevent the status in the USB_STAT register from being set, only from setting the USB_STAT bit in the ISR_0 register.

Table 28 – SIE Status Register

SIE_STAT (0xB0 - RESET=0x00)			SIE STATUS REGISTER
BIT	NAME	R/W	DESCRIPTION
[7]	SET_STALL	R/W	Set to “1” if a SET_FEATURE_ENDPOINT_HALT command is received on any endpoint by the SIE. Which endpoint is STALLED can be determined by examining their CTL registers.
6	CLR_STALL	R/W	Set to “1” if a CLEAR_FEATURE_ENDPOINT_HALT command is received on any endpoint by the SIE. Which endpoint’s STALL condition is cleared can be determined by examining their CTL registers.
5	SET_CONF	R/W	Set to “1” if a SET_CONFIGURATION command is received on endpoint 0 by the SIE and the resulting configuration is set and reported in the USB_CONFIG register.
4	Reserved	R	This read only bit always returns the value of “0”.
3	SET_INTF	R/W	Set to “1” if a SET_INTERFACE command is received on endpoint 0 by the SIE.
2	Reserved	R-	This read only bit always returns the value of “0”.
1	SET_REMWU	R/W	Set to “1” if a SET_FEATURE_REMOTE_WAKE_UP command is received on endpoint 0 by the SIE.
0	CLR_REMWU	R/W	Set to “1” if a CLEAR_FEATURE_ENDPOINT_REMOTE_WAKE_UP command is received on endpoint 0 by the SIE.

Note: These bits are masked by the SIE_MSK register and OR'd to drive the INT3 interrupt line into the 8051 core. They may be cleared writing a “1” to the bit location.

Table 29 – SIE Status Mask Register

SIE_MSK (0xAE - RESET=0xFF)			SIE STATUS MASK REGISTER
BIT	NAME	R/W	DESCRIPTION
[7]	SET_STALL	R/W	1= Disable interrupt generation. 0= Enable interrupt generation.
6	CLR_STALL	R/W	1= Disable interrupt generation. 0= Enable interrupt generation.
5	SET_CONF	R/W	1= Disable interrupt generation. 0= Enable interrupt generation.
4	Reserved	R	This read only bit always returns the value of “1”.
3	SET_INTF	R/W	1= Disable interrupt generation. 0= Enable interrupt generation.
2	Reserved	R	This read only bit always returns the value of “1”.
1	SET_REMWU	R/W	1= Disable interrupt generation. 0= Enable interrupt generation.
0	CLR_REMWU	R/W	1= Disable interrupt generation. 0= Enable interrupt generation.

Note: The mask bits do not prevent the status in the SIE_STAT register from being set, only from driving the INT3 line of the 8051 core high.

Table 30 – USB Configuration Number Register

USB_CONF (0xAD - RESET=0x00)			USB CONFIGURATION NUMBER REGISTER
BIT	NAME	R/W	DESCRIPTION
[7:4]	Reserved	R	Always returns a “0”.
{3:0}	CONFIG	R	Reflects the current configuration number of the USB97C201 system as set by the host.

Table 31 – Endpoint 0 Receive Control Register

EP0RX_CTL (0xAF - RESET=0x00)			ENDPOINT 0 RECEIVE CONTROL REGISTER
BIT	NAME	R/W	DESCRIPTION
[7:4]	Reserved	R	This bit always reads “0”.
3	DTOG	R	This bit reflects the data toggle state of the last received data token.
2	STALL	R/W	When set to a “1”, EP0 will respond with the STALL handshake to OUT tokens EXCEPT a SETUP, which it will ACK unconditionally. Either the internal SIE or the user may set this bit. Receipt of a SETUP packet or USB RESET clears this bit. Writing a “0” to this bit has no effect.
1	Reserved	R	This bit always reads “0”.
0	ENABLE	R	Reads 1 if EP0 Receive is enabled by SIE.

Table 32 – Endpoint 0 Transmit Control Register

EP0TX_CTL (0xB1 - RESET=0x00)			ENDPOINT 0 TRANSMIT CONTROL REGISTER
BIT	NAME	R/W	DESCRIPTION
7	Reserved	R	This bit always reads “0”.
6	Reserved	R	This bit always reads “0”.
5	Reserved	R	This bit always reads “0”.
4	TX	R/W	When written with a “1”, allows the SIE to transfer data from the buffer SRAM to EP0. OUT tokens will be NAK’d until the transfer has been completed. It is cleared by the SIE when transmission of the packet has been completed.
3	Reserved	R	This bit always reads “0”.
2	STALL	R/W	When set to a “1”, EP0 TX will respond with the STALL handshake to IN tokens. . Either the internal SIE or the user may set this bit. Receipt of a SETUP packet or USB RESET clears this bit. Writing a “0” to this bit has no effect.
1	Reserved	R	This bit always reads “0”.
0	ENABLE	R	Reads “1” if EP0 Transmit is enabled by the SIE.

Table 33 – Endpoint 1 Receive Control Register

EP1RX_CTL (0xB2 - RESET=0x00)			ENDPOINT 1 RECEIVE CONTROL REGISTER
BIT	NAME	R/W	DESCRIPTION
[7:4]	Reserved	R	This bit always reads “0”.
3	DTOG	R	This bit reflects the data toggle state of the last received data token.
2	STALL	R/W	When set to a “1”, EP1 RX will respond with the STALL handshake to OUT tokens. . Either the internal SIE or the user may set this bit. Receipt of a “CLEAR FEATURE

EP1RX_CTL (0xB2 - RESET=0x00)			ENDPOINT 1 RECEIVE CONTROL REGISTER
BIT	NAME	R/W	DESCRIPTION
			ENDPOINT CLEAR" command for this endpoint or USB RESET clears this bit. Writing a "0" to this bit has no effect.
1	Reserved	R	This bit always reads "0".
0	ENABLE	R/W	EP1 Receive is enabled in the SIE if this bit is set to a "1", otherwise, it is disabled.

Table 34 – Endpoint 1 Transmit Control Register

EP1TX_CTL (0xB3 - RESET=0x00)			ENDPOINT 1 TRANSMIT CONTROL REGISTER
BIT	NAME	R/W	DESCRIPTION
7	Reserved	R	This bit always reads "0".
6	Reserved	R	This bit always reads "0".
5	Reserved	R	This bit always reads "0".
4	TX	R/W	When written with a "1", allows the SIE to transfer data from the buffer SRAM to EP1. Until the transmission or reception is complete, OUT will be NAK'd. It is cleared by the SIE when transmission of the packet has been completed.
3	Reserved	R	This bit always reads "0".
2	STALL	R/W	When set to a "1", EP1 TX will respond with the STALL handshake to IN tokens. . Either the internal SIE or the user may set this bit. Receipt of a "CLEAR FEATURE ENDPOINT CLEAR" command for this endpoint or USB RESET clears this bit. Writing a "0" to this bit has no effect.
1	Reserved	R	This bit always reads "0".
0	ENABLE	R	EP1 Transmit is enabled in the SIE if this bit is set to a "1", otherwise, it is disabled.

Table 35 – Endpoint 2 Control Register

EP2_CTL (0xB4 - RESET=0x00)			ENDPOINT 2 CONTROL REGISTER
BIT	NAME	R/W	DESCRIPTION
7	DIR	R/W	Setting this bit to a "1" indicates that the data flow is from the ATA interface to the SIE, a "0" indicates the opposite direction. When a "1", the SIE will set the EP2_ERR bit in the USB_STATUS register if an OUT token is received. When a "0", the EP2_ERR bit set if the SIE receives an IN token.
6	RAMWR_TOGVALID	R/W	If this bit is set to a "1" when writes to this register occur, then the value of bit 5 written to this register will have effect. If cleared, then the values of bit 5, when this register is written, is ignored. This bit always returns "0" on reads.
5	RAMWR_TOGGLE	R/W	Writing a "0" to this bit will enable writing of the 512 byte SRAM A buffer and clear the RAMWRBC_A1/2 registers, while writing a "1" will select loading of the SRAM B buffer and clear the RAMWRBC_B1/2 registers. This bit indicates which interleaved buffer is currently or was last written with data. The RAMWRBC_A and RAMWRBC_B Registers contain the byte counts for the last write to the A and B input buffers, respectively. See Sections 6.4, 6.5, and 6.9 for more information. To avoid interrupting a transfer that is in progress, it is important not to write this bit until it is completed. Note that if AutoToggle mode is enabled by bit 3 of the ATA_CTL register, this bit will reflect that current buffer being written(1=B, 0=A).

EP2_CTL (0xB4 - RESET=0x00)			ENDPOINT 2 CONTROL REGISTER
BIT	NAME	R/W	DESCRIPTION
4	RAMRD_TOGGLE	W	Writing a "0" to this bit will begin the output of the 512 byte SRAM A buffer to either the SIE or the ATA interface, depending on the value of the DIR bit in this register, while writing a "1" will begin outputting of SRAM B buffer. See Sections 6.4, 6.5, and 6.9 for more information. The RAMRDBC_A and RAMRDBC_B Registers determine how many bytes will be output from either the A or B SRAM buffer, respectively. Writing this bit to a "1" will clear the RAMRD_B bit in the ISR_0 register, while writing it to "0" will clear the RAMRD_A bit in that register. Note: a delay of at least one NOP must exist before reading the RAMRD_A or RAMRD_B bits in ISR0 when writing this bit.
		R	Upon reads, this bit will reflect the current or last buffer being read (1=B, 0=A).
3	STALL_RX	R/W	When set to a "1", EP2 RX will respond with the STALL handshake to all tokens. . Either the internal SIE or the user may set this bit. This bit is only cleared when a SET FEATURE ENDPOINT 2RX CLEAR or SET CONFIGURATION command is received on EP0 from the host, or by a USB reset.
2	STALL_TX	R/W	When set to a "1", EP2 TX will respond with the STALL handshake to all tokens. . Either the internal SIE or the user may set this bit. This bit is only cleared when a SET FEATURE ENDPOINT 2TX CLEAR or SET CONFIGURATION command is received on EP0 from the host, or by a USB reset.
1	RAMRD_TOGVALID	R/W	This bit always reads "0". If this bit is set to a "1" when writes to this register occur, then the value of bit 4 written to this register will have effect. If cleared, then the values of bit 4, when this register is written, is ignored.
0	ENABLE	R	Reads "1" if EP2 is enabled by the SIE in either direction.

Notes:

- If the DIR bit is changed, then the RAMWR_TOGGLE bit must be written by the user to assure that the proper buffer is selected. The user can NOT rely on reading the value of this bit to determine which buffer is active immediately after changing the DIR bit.
- Bit 2, above, will set the STALL condition for both TX and RX directions of EP2. If the host clears the stall in either direction, then both direction's STALL condition will be cleared. Bit 3 above will be reserved and always read a "0".

Table 36 – Endpoint 0 Receive Byte Count Register

EP0RX_BC (0xB5 - RESET=0x00)			ENDPOINT 0 RECEIVE BYTE COUNT REGISTER
BIT	NAME	R/W	DESCRIPTION
7	Reserved	R	This bit always reads "0".
6	64BYTE	R	1 = Indicates that 64 Bytes were received.
[5:0]	COUNT	R	Indicates the byte count of the packet received on EP0 and stored in SRAM beginning at address 0x0000.

Note: This register is updated at the end of a transfer and is actually the least significant bits of the ending address in the SRAM buffer.

Table 37 – Endpoint 0 Transmit Byte Count Register

EP0TX_BC (0xB6 - RESET=0x00)			ENDPOINT 0 TRANSMIT BYTE COUNT REGISTER
BIT	NAME	R/W	DESCRIPTION
7	Reserved	R	This bit always reads "0".
6	64BYTE	R/W	1 = Indicates that 64 Bytes are to be transmitted.
[5:0]	COUNT	R/W	Indicates the byte count of the packet to be sent on EP0 and stored in SRAM beginning at address 0x0040.

Note: A zero length packet may be sent by just clearing this register and setting the TX bit in the EP0TX_CTL register.

Table 38 – Endpoint 1 Receive Byte Count Register

EP1RX_BC (0xB7 - RESET=0x00)			ENDPOINT 1 RECEIVE BYTE COUNT REGISTER
BIT	NAME	R/W	DESCRIPTION
7	Reserved	R	This bit always reads "0".
6	64BYTE	R	1 = Indicates that 64 Bytes were received.
[5:0]	COUNT	R	Indicates the byte count of the packet received on EP1 and stored in SRAM beginning at address 0x0080.

Notes:

- This register is updated at the end of a transfer and is actually the least significant bits of the ending address in the SRAM buffer.
- This register is cleared if a SETUP packet is received on EP0.

Table 39 – Endpoint 1 Transmit Byte Count Register

EP1TX_BC (0xC7 - RESET=0x00)			ENDPOINT 1 TRANSMIT BYTE COUNT REGISTER
BIT	NAME	R/W	DESCRIPTION
7	Reserved	R	This bit always reads "0".
6	64BYTE	R/W	1 = Indicates that 64 Bytes are to be transmitted.
[5:0]	COUNT	R/W	Indicates the byte count of the packet to be sent on EP1 and stored in SRAM beginning at address 0x00C0.

Note: A zero length packet may be sent by just clearing this register and setting the TX bit in the EP1TX_CTL register.

Table 40 – RAM Buffer Write Byte Count Register A1

RAMWRBC_A1 (0xCE - RESET=0x00)			RAM BUFFER WRITE BYTE COUNT REGISTER A1
BIT	NAME	R/W	DESCRIPTION
[7:2]	Reserved	R	This bit always reads "0".
1	512Bytes	R	1 = Indicates that 512 bytes were transferred
0	COUNT8	R	Bit 8 of the byte count for the data transferred.

Table 41 – RAM BUFFER WRITE Byte Count Register A2 Register

RAMWRBC_A2 (0xCF - RESET=0x00)			RAM BUFFER WRITE BYTE COUNT REGISTER A2
BIT	NAME	R/W	DESCRIPTION
[7:0]	COUNT[7:0]	R	Bits 7 thru 0 the byte count of the data transferred to the SRAM. The data is stored beginning at address 0x0100

Table 42 – RAM Buffer Write Byte Count Register B1

RAMWRBC_B1 (0xD1 - RESET=0x00)			RAM BUFFER WRITE BYTE COUNT REGISTER B1
BIT	NAME	R/W	DESCRIPTION
[7:2]	Reserved	R	This bit always reads “0”.
1	512Bytes	R	1 = Indicates that 512 bytes were transferred
0	COUNT8	R	Bit 8 of the byte count for the data transferred.

Table 43 – RAM Buffer Write Byte Count Register B2 Register

RAMWRBC_B2 (0xD2 - RESET=0x00)			RAM BUFFER WRITE BYTE COUNT REGISTER B2
BIT	NAME	R/W	DESCRIPTION
[7:0]	COUNT[7:0]	R	Bits 7 thru 0 the byte count of the data transferred to SRAM. The packet is stored beginning at address 0x0300.

Table 44 – RAM Buffer Read Byte Count Register A1

RAMRDBC_A1 (0xD3 - RESET=0x00)			RAM BUFFER READ BYTE COUNT REGISTER A1
BIT	NAME	R/W	DESCRIPTION
[7:2]	Reserved	R	This bit always reads “0”.
1	512Bytes	R/W	1 = Indicates that 512 bytes are to transferred
0	COUNT8	R/W	Bit 8 of the byte count for the data to be transferred.

Table 45 – RAM Buffer Read Byte Count Register A2 Register

RAMRDBC_A2 (0xD4 - RESET=0x00)			RAM BUFFER READ BYTE COUNT REGISTER A2
BIT	NAME	R/W	DESCRIPTION
[7:0]	COUNT[7:0]	R/W	Bits 7 thru 0 the byte count of the packet to be transferred from the SRAM. The packet is stored beginning at address 0x0100

Table 46 – RAM Buffer Read Byte Count Register B1

RAMRDBC_B1 (0xD5 - RESET=0x00)			RAM BUFFER READ BYTE COUNT REGISTER B1
BIT	NAME	R/W	DESCRIPTION
[7:2]	Reserved	R	This bit always reads “0”.
1	512Bytes	R/W	1 = Indicates that 512 bytes are to transferred
0	COUNT8	R/W	Bit 8 of the byte count for the data to be transferred.

Table 47 – RAM Buffer Read Byte Count Register B2 Register

RAMRDBC_B2 (0xD6 - RESET=0x00)			RAM BUFFER READ BYTE COUNT REGISTER B2
BIT	NAME	R/W	DESCRIPTION
[7:0]	COUNT[7:0]	R/W	Bits 7 thru 0 the byte count of the packet to be transferred from the SRAM. The packet is stored beginning at address 0x0300.

Table 48 – NAK Register (INT5)

NAK (0xD7 - RESET=0x00)			NAK REGISTER
BIT	NAME	R/W	DESCRIPTION
7	NYET2RX	R	1 = indicates that an NYET has been sent to the host on Endpoint 2 in response to an OUT token.
6	NYET0RX	R	1 = indicates that an NYET has been sent to the host on

NAK (0xD7 - RESET=0x00)			NAK REGISTER
BIT	NAME	R/W	DESCRIPTION
			Endpoint 0 in response to an OUT token.
5	NAK2TX	R	1 = indicates that an NAK has been sent to the host on Endpoint 2 in response to an IN token.
4	NAK2RX	R	1 = indicates that an NAK has been sent to the host on Endpoint 2 in response to an OUT token.
3	NAK1TX	R	1 = indicates that an NAK has been sent to the host on Endpoint 1 in response to an IN token.
2	NAK1RX	R	1 = indicates that an NAK has been sent to the host on Endpoint 1 in response to an OUT token.
1	NAK0TX	R	1 = indicates that an NAK has been sent to the host on Endpoint 0 in response to an IN token.
0	NAK0RX	R	1 = indicates that an NAK has been sent to the host on Endpoint 0 in response to an OUT token.

Notes:

- Any bit that is high in this register, if not masked by the corresponding mask bit in the NAK_MSK register will generate INT5 to the 8051.
- A bit in this register may be cleared by writing a "1" to it.

Table 49 – NAK Mask Register

NAK_MSK (0xD9- RESET=0xFF)			NAK MASK REGISTER
BIT	NAME	R/W	DESCRIPTION
7	NYET2RX	R/W	1 = Prevents generation of the 8051 INT5 interrupt when the NYET2RX bit is set in the NAK register.
6	NYET0RX	R/w	1 = Prevents generation of the 8051 INT5 interrupt when the NYET0RX bit is set in the NAK register.
5	NAK2TX	R/W	1 = Prevents generation of the 8051 INT5 interrupt when the NAK2TX bit is set in the NAK register.
4	NAK2RX	R/W	1 = Prevents generation of the 8051 INT5 interrupt when the NAK2RX bit is set in the NAK register.
3	NAK1TX	R/W	1 = Prevents generation of the 8051 INT5 interrupt when the NAK1TX bit is set in the NAK register.
2	NAK1RX	R/W	1 = Prevents generation of the 8051 INT5 interrupt when the NAK1RX bit is set in the NAK register.
1	NAK0TX	R/W	1 = Prevents generation of the 8051 INT5 interrupt when the NAK0TX bit is set in the NAK register.
0	NAK0RX	R/W	1 = Prevents generation of the 8051 INT5 interrupt when the NAK0RX bit is set in the NAK register.

Table 50 – USB Error Register

USB_ERR (0xDA - RESET=0x00)			USB ERROR REGISTER
BIT	NAME	R/W	DESCRIPTION
7	Reserved	R	This bit always reads a "0".
6	TOKEN	R/W	When set, this bit indicates that an unexpected token has been received on one of the device's endpoints.
5	Reserved	R	This bit always reads a "0".
4	STALL	R/W	When set, indicates that a token has been received on a endpoint of the device while that endpoint is in the STALL condition.
3	DTOG	R/W	When set, indicates that a data packet has been received on one of the device's endpoints that has an incorrect data toggle.

USB_ERR (0xDA - RESET=0x00)			USB ERROR REGISTER
BIT	NAME	R/W	DESCRIPTION
2	RXERR	R/W	When set, indicates that a packet has been received on one of the device's endpoint with an error in FS mode.
1	Reserved	R	This bit always reads a "0".
0	CRC	R/W	When set, indicates that a packet with an incorrect CRC has been received on an endpoint.

Note: Writing a "1" to a bit in this register will clear the bit.. If any bit is set in this register the USB_ERR bit is set in the USB_STAT register.

Table 51 – MSB ATA Data Register

MSB_ATA (0xDB - RESET=0x00)			MSB ATA CONTROL/STATUS DATA REGISTER
BIT	NAME	R/W	DESCRIPTION
[7:0]	D[15:8]	R/W	During 8051 writes to XDATA 0x31F0 (the ATA Drives Control/Status register), data in this register represents the MS byte of the 16 bit operation to this address. For a read of 0x31F0, the MS byte data is returned in this register after the PIO_COMPLETE bit is set in the ATA_CTL register. (the data returned from the actual read of 31F0 should be discarded)

Table 52 – LSB ATA Data Register

LSB_ATA (0xDC - RESET=0x00)			LSB ATA CONTROL/STATUS DATA REGISTER
BIT	NAME	R/W	DESCRIPTION
[7:0]	D[7:0]	R/W	During 8051 reads to XDATA 0x31F1-7 and 33F6 (the ATA Drive's 8 bit registers), the actual data is returned in this register after the PIO_COMPLETE bit is set in the ATA_CTL register. During writes, this register is unused. For 8051 read to XDATA 0x31F0, the LS byte of data is returned in this register after the PIO_COMPLETE bit is set in the ATA_CTL register. During writes, this register is unused.

Table 53 – ATA Transfer Count Register 0

ATA_CNT0 (0xE1 - RESET=0x00)			ATA TRANSFER COUNT REGISTER 0
BIT	NAME	R/W	DESCRIPTION
[7:0]	D[7:0]	R/W	See note below.

Table 54 – ATA Transfer Count Register 1

ATA_CNT1 (0xE2 - RESET=0x00)			ATA TRANSFER COUNT REGISTER 1
BIT	NAME	R/W	DESCRIPTION
[7:0]	D[15:8]	R/W	See note below.

Table 55 – ATA Transfer Count Register 2

ATA_CNT2 (0xE3 - RESET=0x00)			ATA TRANSFER COUNT REGISTER 2
BIT	NAME	R/W	DESCRIPTION
[7:0]	D[23:16]	R/W	See note below.

Table 56 – ATA Transfer Count Register 3

ATA_CNT3 (0xE4 - RESET=0x00)			ATA TRANSFER COUNT REGISTER 3
BIT	NAME	R/W	DESCRIPTION
[7:0]	D[31:24]	R/W	See note below.

Note: The ATA_CNT[3:0] register must be written with the byte count of the total ATA transfer to be made. Writing the ATA_CNT0 register initializes the ATA block for the transfer and should be written last. Reading these registers, will return the actual number of bytes remaining to be transferred. If the transfer is prematurely terminated or aborted, then the ATA_ERR bit in the ATA_CTL register will be set.

Table 57 –ATA Control Register

ATA_CTL (0xDD - RESET=0x00)			ATA CONTROL REGISTER
BIT	NAME	R/W	DESCRIPTION
7	OUT_CONTROL	R/W	Setting this bit to a “1” allows the IDE_SA[2:0], IDE_nIOR, IDE_nIOW, IDE_nCS1, IDE_nCS0, IDE_DACK, and IDE_D[15:0] pins operate normally. When cleared (“0”), these pins are high impedance.
6	PIO COMPLETE	R/W	This bit is set once any PIO access to the external drive registers (31F0-31F7 & 33F6) has been completed (see Section 6.3.2 for more information on PIO accesses). This bit is cleared by writing a “1” to it. The value of the this bit is mirrored in the ISR_1 register to allow an interrupt to be generated, if desired. This bit is also cleared at the start of any PIO access to the external drive registers.
5	ATA_ABORT	R/W	Setting this bit to a “1” will abort any ATA transfer to/from the external device. The ATA_ERR bit will be set, also. It is cleared upon initializing the next ATA transfer by writing a value into the ATA_CNT0 register.
4	ATA_ERR	R	A “1” on this bit indicates that an error has occurred during the ATA transfer/to/from the drive. It is cleared upon initializing the next ATA transfer by writing a value into the ATA_CNT0 register.
3	AUTO_TOG	R/W	When set to “1”, enables the automatic toggling between the A and B SRAM buffers when writing to the SRAM. See Section 6.9 on page 50 for more information
2	AUTO_TRANS	R/W	When set to a “1”, enables the automatic transfer mode of operation. See Section 6.9 on page 50 for details. Writing this bit to a “1”, automatically enables the automatic toggling operation also, independent of the state of the AUTO-TOG bit above.
1	Reserved	R	This bit always returns a “1”.
0	ENO	R/W	Primary Drive 0 UDMA Enable. 1: Enable UDMA mode for primary channel drive 0. 0: Disable (default)..

Note: If an ATA_ERR occurs, the state of which buffers (A or B) are being used for reading or writing from/to the ATA block are unchanged. The firmware may determine which buffer was being used by the ATA at the time of the error by reading either bit 4 or bit 5 of the EP2_CTL register and determine how much of the transfer was completed by reading the ATA_CNx registers.

Table 58 –ATA Ultra DMA Timing Register

ATA_DMA (0xDE - RESET=0x00)			ATA ULTRA DMA TIMING REGISTER
BIT	NAME	R/W	DESCRIPTION
[7:3]	Reserved	R	These bits always reads "0".
[2:0]	DMA_TMG[2:0]	R/W	<p>Drive Timing.</p> <p>These bit settings the Ultra DMA mode that the ATA interface operates when Ultra DMA operation is enabled. They therefore determine the minimum data write strobe Cycle Time (CT) and minimum Ready to Pause time (RP). are shown below:</p> <p>000: CT= 267ns, RP= 333ns (Mode 0) 001: CT= 167ns, RP= 266ns (Mode 1) 010: CT= 133ns, RP= 200ns (Mode 2) 011: CT= 100ns, RP= 200ns (Mode 3) 100: CT= 66ns, RP= 200ns (Mode 4) 101 thru 111 reserved</p>

ULTRA DMA TIMING MODES					
Mode (Data Strobe Cycle Time)	Mode 0 (~1267ns)	Mode 1 (~167ns)	Mode 2 (~133ns)	Mode 3 (~100ns)	Mode 4 (~66ns)
Bit Settings	000	001	010	011	100

Table 59 – IDE Timing Register

IDE_TIM (0xDF - RESET=0x00)			IDE TIMING REGISTER
BIT	NAME	R/W	DESCRIPTION
[7:6]	ISP[1:0]	R/W	<p>IORDY Sample Point. This field selects the number of 30MHz clocks (33ns/clock) between IDE_nIOx assertion and the first IORDY sample point. In fast PIO timing mode (See bit 3 below), this sets the active period for the data strobe.</p> <p>Bits [7-6]Number of Clocks</p> <p>00 5 clocks 01 4 clocks 10 3 clocks 11 2 clocks.</p>
[5:4]	RT[0:1]	R/W	<p>Recovery Time. This field selects the minimum number of 30MHz clocks(33ns/clock) between the last IORDY sample point and the next IDE_nIOx strobe. In fast PIO timing mode (See bit 3 below), this sets the inactive period for the data strobe.</p> <p>Bits [5-4]Number of Clocks</p> <p>00 4 clocks 01 3 clocks 10 2 clocks 11 1 clock.</p>
3	DTE	R/W	<p>DMA Timing Enable Only.</p> <p>1: Fast timing mode is enabled for non-UDMA DMA data. PIO transfer to the IDE data port will run in compatible timing. 0: Both non-UDMA DMA and PIO data transfers to drive will use the fast timing mode.</p>

IDE_TIM (0xDF - RESET=0x00)			IDE TIMING REGISTER
BIT	NAME	R/W	DESCRIPTION
2	PPE	R/W	Prefetch and Posting Enable. 1: Prefetch and posting to the IDE data port is enabled for the drive. 0: Prefetch and posting is disabled for the drive .
1	ISPE	R/W	IORDY Sample Point Enable. 1: All accesses to the ATA I/O address range sample IORDY. The IORDY sample point is specified by the "IORDY Sample Point" field of this register. 0: IORDY sampling is disabled. The internal IORDY signal is forced asserted guaranteeing that IORDY is sampled asserted at the first sample point as specified by the "IORDY Sample Point" field in this register.
0	FTB	R/W	Fast Timing Bank. 1: Accesses to the data port of the ATA IO address range uses fast timings. PIO accesses to the data port use fast timing only if bit 3 of this register is zero. Accesses to all non-data ports of the ATA I/O address range always use the 8 bit compatible timings. 0: Accesses to the data port of the ATA I/O address range uses the 16 bit compatible timing.

Note: the following settings should be used for the ISP, RT, DTE, and FTB bits for the various PIO and MWDMA modes:

MODE	ISP[1:0]	RT[1:0]	FTB	DTE	COMMENT
PIO Mode 0	00	11	1	0	ATA PIO cycle speed limited by 8051 data moves
PIO Mode 1	01	11	1	0	ATA PIO cycle speed limited by 8051 data moves
PIO Mode 2-4	10	11	1	0	ATA PIO cycle speed limited by 8051 data moves
MWDMA 0	00	00	0	x	requires compatibility mode timing to be used
MWDMA 1	10	10	1	x	
MWDMA 2	10	11	1	x	

Table 60 –ATA Slew Rate Control A Register

ATA_SRC A (0xE5 - RESET=0x00)			ATA SLEW RATE CONTROL A REGISTER
BIT	NAME	R/W	DESCRIPTION
[7:6]	SLEW3	R/W	These two bits are control inputs of the ATA pad for data bits [15:12]. The bits can be used to vary the slew rate of IDE_D[15:12] from minimum to maximum rate specified by the ATA66 specification. The value 11b sets the slew rate to be the maximum and the value of 00b sets the slew rate to be the minimum.
[5:4]	SLEW2	R/W	These two bits are control inputs of the ATA pad for data bits [11:8]. The bits can be used to vary the slew rate of IDE_D[11:8] from minimum to maximum rate specified by the ATA66 specification. The value 11b sets the slew rate to be the maximum and the value of 00b sets the slew rate to be the minimum.
[3:2]	SLEW1	R/W	These two bits are control inputs of the ATA pad for data bits [7:4]. The bits can be used to vary the slew rate of IDE_D[7:4] from minimum to maximum rate specified by the ATA66 specification. The value 11b sets the slew rate to be the maximum and the value of 00b sets the slew rate to be the minimum.
[1:0]	SLEW0	R/W	These two bits are control inputs of the ATA pad for data bits [3:0]. The bits can be used to vary the slew rate of IDE_D[3:0] from minimum to maximum rate specified by the ATA66 specification. The value 11b sets the slew rate to be the maximum and the value of 00b sets the slew rate to be the minimum.

Table 61 –ATA Slew Rate Control B Register

ATA_SRC B (0xE6 - RESET=0x00)			ATA SLEW RATE CONTROL B REGISTER
BIT	NAME	R/W	DESCRIPTION
[7:2]	Reserved	R	Always returns “0” on reads
[1:0]	SLEW4	R/W	These two bits are control inputs of the ATA pad for STROBE signaling during Ultra ATA writes to disk. The bits can be used to vary the slew rate of STROBE from minimum to maximum rate specified by the ATA66 specification. The value 11b sets the slew rate to be the maximum and the value of 00b sets the slew rate to be the minimum.

6.2 SIE Block

The SIE is a USB low-level protocol interpreter. The SIE controls the USB bus protocol, packet generation / extraction, PID / Device ID parsing, and CRC coding / decoding with autonomous error handling.

Parallel-to-serial / serial-to-parallel conversion, bit stuffing, and NRZI coding / decoding are handled in the PHY block.

It is capable of operating either in USB 1.1 or 2.0 compliant modes. Unlike the normal 97Cxxx series SIEs, it has more autonomous protocol handling functions like stall condition clearing on setup packets, suspend / resume / reset conditions, and remote wakeup. It also autonomously handles the error conditions such as retry for CRC errors, Data toggle errors, and generation of NYET, STALL, ACK and NACK depending on the endpoint buffer status.

During the power down state, the SIE clock is stopped. The SIE can asynchronously detect a USB Reset and/or USB Resume condition and wakeup the 8051.

6.2.1 AUTONOMOUS USB PROTOCOL

6.2.1.1 Automatic Retries - Out Transactions

If a packet is received with an incorrect data toggle, the SIE will ACK, but ignores the data packet. If more than 64 bytes received on EP0RX or EP1RX, or if more than 512 bytes are received on EP2, the USB SIE will ignore the packet and set the appropriate "STALL" bit until the host acknowledges the condition by sending a "CLEAR FEATURE ENDPOINT STALL" command for that endpoint, or, in the case of Endpoint 0, a SETUP is received.

If an error occurs during an OUT transaction, the USB97C201 reloads its USB SIE read pointer back to the beginning of the buffer. The host then sends another OUT token and retransmits the packet.

Once the packet has been successfully received, the appropriate interrupt bit is set in ISR_0 or ISR_1. The SIE can handle any number of back-to-back retries, but the host determines how many times a packet is retried.

If an endpoint's buffer or buffers (in the case of EP2) are full, then the SIE sends a NACK. A TX direction Endpoint will NAK all OUT packets.

6.2.1.2 Automatic Retries - In Transactions

If an timeout (No response from the host / lost ACK) occurs during an IN transaction, the USB97C201 reloads its USB SIE side buffer read pointer back to the beginning of the failed packet. The host then sends another IN token and the SIE re-transmits the packet with the same data toggle PID.

Once the host has successfully received the packet (only upon ACK received by SIE), the appropriate interrupt bit is set in ISR_0 or ISR_1. The SIE can handle any number of back-to-back retries, but the host determines how many times a packet is retried.

Upon reception of a SETUP token followed by the 8 byte DATA-0 packet on EP0, the internal DTOG bit for both EP0RX and EP0TX are set to one.

6.2.1.3 Packet Lengths

The maximum packet length of an endpoint is fixed and 64 bytes for EP0 and EP1, and is 512 bytes for EP2 in HS mode and 64 bytes in FS mode. For IN transactions, the USB97C201 will send the bytes in the buffer to the host. For all OUT packets, the number of bytes received in the packet is indicated to the 8051 through the **BYTE COUNT** Register of the respective endpoint.

6.2.2 USB EVENTS

There are several events, which cause different parts of the SIE to be initialized. The following is the list of events and the respective actions.

6.2.2.1 Reset

A reset via the external nRESET pin causes the following:

1. All endpoints are disabled, all SIE endpoint buffers are cleared, all stall conditions, and all registers clear to their default state.
2. If USB97C201 was in power down state, then it is cleared.
3. The external crystal oscillator is allowed to run.

6.2.2.2 USB Bus Reset

USB Bus Reset is recognized only when the clocks are running. If the device is in SUSPEND mode with the clocks stopped, a USB RESET will be first recognized as a RESUME event and if the WU_SRC1 bit for RESUME is unmasked, will restart the clocks. The USB RESET can only then be detected. Upon recognition it causes the following:

1. All SIE endpoint buffer byte count registers are cleared, all stall conditions, the SETUP bit, SETUP_DELAY bit, SIE_SUSPEND, SIE_RESUME are cleared. The PID sequencers, internal DTOG are reset for all endpoints
2. The following registers will be set to their POR values: USB_ADD, SIE_STAT, USB_CONF, EP0RX_CTL, EP0TX_CTL, EP1RX_CTL, EP1TX_CTL, EP2_CTL, EP0RX_BC, EP0TX_BC, EP1RX_BC, EP1TX_BC, RAMWRBC_A1, RAMWRBC_A2, RAMWRBC_B1, RAMWRBC_B2, RAMRDBC_A1, RAMRDBC_A2, RAMRDBC_B1, RAMRDBC_B2, NAK, USB_ERR.
3. The seven bit USB device address is cleared.
4. Both EP0TX and EP0RX endpoints are enabled.

5. If the USB_RESET and USB_STAT bits are unmasked, then a ISR_0 interrupt (USB_STAT) is generated to the 8051 and the USB_RESET bit in the WU_SRC1 register will also be set and will generate an interrupt if unmasked.

6.2.2.3 Suspend

This is detected by the SIE when the idle condition on the USB bus occurs for a duration of more than 3ms. Upon detection of this condition via the SUSPEND bit of ISR_1, the 8051 will place the USB97C201 into a low power mode via the USB_SUSPEND bit and enter into a power down state.

6.2.2.4 Setup token Arrival

When a SETUP token is recognized, the following sequence happens.

1. Independent of the state of SETUP bit, the setup data packet is received on EP0RX and ACK is sent for the received setup packet.
2. The stall condition, if any, for EP0TX and EP0RX are cleared, as well as the EP0RX_BC and EP0TX_BC registers and the TX bit of EPO_CTL register .
3. The internal DTOG bit for both EP0TX and EP0RX are set to one.
4. The EP0RX_BC register is cleared, allowing the subsequent data packet(if not zero length) to be written into the start of the buffer.
5. The SETUP bit in ISR_0 register is set. Until the SETUP bit is cleared by the 8051, all OUT packets to EP0RX are NACKed.

6.2.2.5 Resume

This global resume condition is recognized asynchronously and does not require the SIE clock running. Upon recognition it causes the following. A USB RESET will be interpreted as a RESUME if it occurs while clocks are stopped.

If the USB_RESUME and USB_STAT bits are unmasked, then a ISR_0 interrupt (USB_STAT) is generated to the 8051. Also the RESUME bit in the WU_SRC1 register will be set and can generate an interrupt, if unmasked. The SIE_SUSPEND bit is cleared automatically and the SIE resumes from power down state.

6.2.2.6 Remote Wakeup

When the 8051 is required to go into power down state, the SIE_SUSPEND should be set. When a remote wakeup event is desired, the 8051 is responsible to clear the SIE_SUSPEND, and set the SIE_RESUME bits.

6.2.3 STANDARD DEVICE REQUESTS

The SIE also handles autonomously several standard device requests received on Endpoint 0.

These requests are:

- SET_CONFIGURATION
- GET_CONFIGURATION
- SET_FEATURE_ENDPOINT_HALT
- CLEAR_FEATURE_ENDPOINT_HALT
- SET_FEATURE_REMOTE_WAKE_UP
- CLEAR_FEATURE_REMOTE_WAKE_UP
- GET_INTERFACE
- SET_INTERFACE
- SET_ADDRESS

These events (except SET_ADDRESS, GET_INTERFACE (always returns 0), and GET_CONFIGURATION) are indicated in the SIE_STATUS register, which can generate an interrupt to the 8051 core's INT3 line. The configuration number, resulting from the SET_CONFIGURATION command is stored in the USB_CONF register. This value is used when reporting to the host on a GET_CONFIGURATION Command, also. All other device requests are handled normally and will generate the SETUP status bit when received.

6.2.4 SIE CONFIGURATIONS

Upon POR or the detection of USB RESET, the Configuration of the device is set to "0". The host may change its Configuration state to "1" with a "SET CONFIGURATION" command on Endpoint 0. All other Configuration number requests by the host will result in a STALL condition on Endpoint 0. For Configuration 0, only Endpoint 0 RX and TX are enabled, while all endpoints are enabled for Configuration 1.

6.3 IDE Controller Description

This is an ATA-66 core. The PIO I/O address range for the ATA interface in the 8051 XDATA space is decoded in the range of 0X31F0 to 0X31F7, and 0x33F6

Transfers to/from SRAM will occur from/to the 16 bit ATA Data Port at CS0=1, CS1=0, A2-A0= 0.

The most significant byte of transfer to/from this Data Port is available to the 8051 via the register located in SFR space at 0xDB. Writes to 0x31F0 in the XDATA space by the 8051 would write both the contents of this register and the data in the MOVEX instruction as a 16 bit DWORD to the ATA Data Port. Similarly, reads by the 8051 of 0x31F0 will return the actual drive data for reading by the 8051 at 0xDB and 0xDC.

6.3.1 IDE CONFIGURATIONS

The USB97C201 supports only a single primary drive on the IDE interface.

6.3.2 PIO IDE OPERATIONS

The IDE controller includes both compatible and fast timing modes. The fast timing mode only applies to the IDE data ports. All other transactions to the IDE registers are run in single transaction mode with compatible timings.

The IDE_TIM register permits different timing modes, from Multi-word DMA ATA Mode 0 to ATA Mode 2, to be programmed for the drive. These modes range from 3MB/sec to 16MB/sec in terms of data transfer rate. The Ultra ATA/66 synchronous DMA timing modes can also be applied to each drive by programming the ATA_CTL and ATA_DMA registers. When a drive is enabled in Ultra DMA mode operation, the DMA transfers are executed with the Ultra ATA timings. The PIO data transfers are still executed using compatible timings or fast timings when enabled.

PIO accesses are not directly made to the drive from the 8051 via its XDATA address space, but are timed by the ATA controller to meet required drive timing. A read access is accomplished by first reading the XDATA address location, ignoring the returned data, and then waiting for the PIO_COMPLETE bit to be set in the ATA_CTL register. The actual data retrieved from the drive can then be read at LSB and MSB(if a 16 bit access to 31F0) ATA Data registers in SFR space. Writes to the drive are done normally, directly to the XDATA address desired(the MSB ATA Data register must be loaded first for the 16 bit writes to 31F0), but a subsequent write (or read) cannot be initiated until the PIO_COMPLETE bit is set. This bit is reflected in the ISR_1 register to allow an interrupt to be generated, if desired.

Startup Latency: If the IDE_SA[2:0] and IDE_nCS[1:0] lines are not set up, startup latency is incurred when a cycle that accesses the IDE data port is decoded. Startup latency provides the setup time for assertion of IDE_SA[2:0] and IDE_nCS[1:0] lines prior to assertion of the read and write strobes (IDE_nIOR and IDE_nIOW).

Cycle Latency: Cycle latency consists of the I/O command strobe assertion length and recovery time. Recovery time is needed so that back-to-back transactions, which does not incur startup and shutdown latency, may occur on the IDE interface without violating minimum cycle periods for the IDE interface. The command strobe assertion width (IORDY Sample Point: ISP) for the fast timing mode is programmable in the ISP field of the IDE_TIM Register. The recovery time (RCT) is programmable in the RCT field of the IDE_TIM Register.

If the IORDY is asserted when the IORDY sample point is reached, no wait states are added to the command strobe assertion length. If IORDY is negated when the sample point is reached, additional wait states are added.

IORDY Masking: The IORDY signal can be ignored and assumed asserted at the first IORDY Sample Point (ISP) through the IDE_TIM register.

Shutdown Latency: Shutdown latency is incurred after the IDE data transactions (either a non-empty write post buffer to the IDE drive or an outstanding read prefetch cycles from the IDE drive) have completed and before other IDE transactions can proceed. The latency provides hold time on the IDE_SA[2:0] and IDE_nCS[1:0] lines with respect to the read and write strobes (IDE_nIOR and IDE_nIOW). Shutdown latency is set to 67ns in duration.

Table 62 shows the IDE cycle timings for various IDE transaction types.

Table 62 – IDE Transaction Timing

IDE TRANSACTION TYPE	STARTUP LATENCY	ISP	RCT	SHUTDOWN LATENCY
Non-Data Port Compatible	133ns	367ns	733ns	67ns
Data Port Compatible	100ns	200ns	467ns	67ns
Fast Timing Mode (for Data Port Accessing)	67ns	267-167ns	33-133ns	67ns

6.3.3 PIO IDE DATA PREFETCHING AND POSTING

The IDE Controller can be programmed via the IDE_TIM registers to allow data to be posted to and prefetched from the IDE data ports. Data prefetching is initiated when a data port read occurs. The read prefetch eliminates latency to the IDE data ports and allows them to be performed back to back for the highest possible PIO data transfer rates. The first data port read of a sector is called the demand read. Subsequent data port reads from the sector are called prefetch reads. The demand read and all prefetch reads must be of the same size (16 or 32 bits).

Data posting is performed for writes to the IDE data ports. The IDE CONTROLLER will then run the IDE cycle to transfer the data to the drive.

6.3.4 DMA TRANSFERS

When enabled and supported by the device, DMA transfers are executed on the IDE interface, the chip selects (IDE_nCS1/0) will be negated (high). When the IDE device asserts IDE_DRQ, the IDE Controller will return IDE_nDACK to the IDE device when it is ready for the DMA data transfer. For multiword DMA transfers, the IDE_nIOR or IDE_nIOW signal will free run at the programmed rate as long as IDE_DRQ remains asserted and the IDE Controller is prepared to complete a data transfer. If IDE_DRQ has not de-asserted by the rising edge of IDE_nIOR or IDE_nIOW signal multiword DMA is assumed and at least one more cycle will be executed. If IDE_DRQ de-asserts before IDE_nIOR or IDE_nIOW is de-asserted while IDE_nDACK is asserted, it indicates that one last data transfer remains for the current session. In this case, IDE_nDACK will be de-asserted one clock after the IDE_nIOR or IDE_nIOW signal de-asserts. This allows the IDE controller to support both single and multiword DMA cycles automatically.

The IDE device's DMA request signal is sampled when the IO strobe is deasserted. If inactive, the DMA Acknowledge signal is deasserted and no more transfers take place until DMA request is again asserted.

The controller transfers data to or from the EP2 buffer(s) responding to the DMA requests from the IDE device. The controller will continue this until stopped or the byte count in ATA_CNT[3:0] reaches zero.

6.3.4.1 Completion of DMA Data Transfers

The IDE device signals an interrupt (IDE_IRQ) once its programmed data count has been transferred or an error occurs. The IDE device will also deassert its DMA request signal, causing the IDE Controller to stop transferring data. On reads from the IDE device, it will cause any data read from the device to be transferred to the EP2 buffer(s), as they become available.

6.3.5 ULTRA ATA/66 SYNCHRONOUS DMA OPERATION

Ultra ATA/66 is a new IDE transfer protocol used to transfer data between a Ultra ATA/66 capable IDE controller and Ultra ATA/66 capable IDE devices. Ultra DMA/66 utilizes a “source synchronous” signaling protocol to transfer data at rates up to 66 Mbytes/sec.

6.3.5.1 Ultra ATA/66 Signals

Although no additional signal pins are required for Ultra ATA/66 operation, the operation of some standard IDE controller pins are redefined during Ultra ATA modes of operation. The Ultra DMA/66 protocol defines three hand-shaking signals: STOP, STROBE and DMARDY. Table 63 shows the mapping of the redefined Ultra ATA/66 signals onto the standard IDE controller pins.

STOP: STOP is always driven by the the USB97C201 and is used to request that a transfer be stopped or as an acknowledgment to stop a request from IDE device. The IDE_nIOW signal is redefined as STOP for both read and write transfers.

STROBE: This is a data strobe signal driven by the TRANSMITTER of a data transfer, which is either the IDE device of a DMA Read transfer or the USB97C201 of a DMA Write transfer, on which data is transferred during each rising and falling edge transition of the signal. The IORDY signal is redefined as STROBE for reads (when transferring data from the IDE device to the USB97C201). The IDE_nIOR signal is redefined as STROBE for writes (transferring data from the USB97C201 to the IDE device).

nDMARDY: This is a signal driven by the RECEIVER of a data transfer, which is either the USB97C201 of a DMA Read transfer or the IDE device of a DMA Write transfer, to signal that the RECEIVER is ready to transfer data or to add wait states to the current transaction. The IDE_nIOR signal is redefined as nDMARDY for reads (when transferring data from the IDE device to the USB97C201). The IORDY signal is redefined as nDMARDY for writes (transferring data from the USB97C201 to the IDE device).

Table 63 – ULTRA ATA/66 Control Signal Assignments

STANDARD IDE SIGNAL NAME	SIGNAL NAME DURING ULTRA ATA/66 READ CYCLE	SIGNAL NAME DURING ULTRA ATA/66 WRITE CYCLE
IDE_nIOW	STOP	STOP
IDE_nIOR	nDMARDY	STROBE
IORDY	STROBE	nDMARDY

Note:

“Ultra ATA/66 Read Cycle”: Data transfers are from the IDE device to the USB97C201.

“Ultra ATA/66 Write Cycle”: Data transfers are from the USB97C201 to the IDE device.

6.3.6 ULTRA ATA/66 OPERATION

After initialization, there are two primary operations provided by the Ultra ATA/66 controller: data transfers and cyclic redundancy checking (CRC).

6.3.6.1 Initialization

Initialization includes enabling and performing proper set up on the USB97C201 and the IDE device. For the USB97C201, it is necessary to enable Ultra ATA/66 mode for the IDE device and setting up the Ultra ATA/66 cycle timings through the ATA_DMA register. The USB97C201 supports five timing modes: Mode 0 (120ns cycle time), Mode 1 (80 ns cycle time), Mode 2 (60ns cycle time), Mode 3 (45ns cycle time), and Mode 4 (30ns cycle time).

6.3.6.2 Data Transfer Operation

The USB97C201 and the Ultra ATA compatible IDE device control the transfer via the Ultra ATA protocol. The actual data transfer consists of three phases, a start-up phase, a data transfer phase, and a burst termination phase.

- 1) **Start-Up Phase:** The IDE device begins the start-up phase by asserting DRQ signal. When ready to begin the transfer, the USB97C201 will assert nDACK. When nDACK is asserted, the USB97C201 will drive CS0/1 inactive, and A0-A2 low.
 - For Write cycles, the USB97C201 will deassert STOP, wait for the IDE device to assert nDMARDY and then drive the first data word and the STROBE signal.
 - For Read cycles, the USB97C201 will tristate the data lines, deassert STOP, and assert nDMARDY. The IDE device will then drive the first data word and the STROBE signal.

- 2) **Data-Transfer Phase:** The burst data transfer continues with the data source (Writes: USB97C201, Reads: IDE devices) providing data and toggling STROBE. Data is transferred (latched by receiver) on each rising and falling edge of STROBE.
 - The source can pause the burst stream by holding STROBE high or low, resuming the burst stream by again toggling STROBE.
 - The receiver can pause the burst stream by negating the nDMARDY and resumes the transfers by asserting nDMARDY.

The USB97C201 may pause a burst transaction in order to toggle internal data buffer, or to prevent a buffer over or under flow condition, resuming once the condition has cleared.

- 1) **Termination Phase:** Either the source or the receiver can terminate a burst transfer. A burst termination consists of a Stop Request, Stop Acknowledge and transfer of CRC data.
 - The USB97C201 can stop a burst by asserting STOP, with the IDE device acknowledged by deasserting DRQ.
 - The IDE device stops a burst by deasserting DRQ and the USB97C201 acknowledges by asserting STOP.
 - The source then drives the STROBE signal to a high level. The USB97C201 then drive the CRC value onto the data lines and deassert nDACK. The IDE devices will latch the CRC value on the rising edge of nDACK.

The USB97C201 will terminate a burst transfer if a Programmed I/O (PIO) cycle is executed to the IDE channel currently running the burst, or upon transferring the last data from the final PRD.

At the completion of the entire transfer process, the IDE device will issue an interrupt, setting the ATA_IRQ bit and forcing the remaining data to be sent to host on read operations.

6.3.6.3 Cyclic Redundancy Checking (CRC) Calculation

Cyclic Redundancy Checking (CRC-16) is used for error checking on Ultra ATA/66 transfers. The CRC value is calculated for all data by both the USB97C201 and the IDE device over the duration of the DMA burst transfer segment. This segment is defined as all data transferred with a valid STROBE edge from DACK assertion to nDACK deassertion. At the end of the transfer burst segment, the USB97C201 will drive the CRC value onto the D[15:0] signals. The value is then latched by the IDE device on deassertion of nDACK. The IDE device compares the USB97C201 CRC value to its own and reports an error if there is a mismatch.

6.4 SRAM Buffers

1.25K Bytes of Buffer SRAM are provided. The Memory Map of the buffers are given below:

Table 64 –Buffer SRAM Mapping

SRAM ADDRESS	BUFFER DESCRIPTION
0x300 – 0x4FF	SRAM B 512 byte EP2/ATA buffer
0x100 – 0x2FF	SRAM A 512 byte EP2/ATA buffer
0x0C0 – 0x0FF	64 Byte EP1 TX Buffer
0x080 – 0x0BF	64 Byte EP1 RX Buffer
0x040 – 0x07F	64 Byte EP0 TX Buffer
0x000 – 0x03F	64 Byte EP0 RX Buffer

Note: The above SRAM address in the table refers to the BYTE location within the SRAM. The SRAM is actually physically organized as a 32 bit wide memory.

The buffers used for EP2 is organized as two 512 byte buffers: A and B. The A buffer has its address starting at 0X100, while the B is at address 0X300.. Byte counts for data received or to be transmitted is contained in the RAMWRBC_A/B and RAMRDBC_A/B register sets, respectively. The direction of data flow is determined by the DIR bit in the EP2 Control register. If DIR=0 then data flow is from the SIE to SRAM and from the SRAM to the ATA interface. If DIR=1 the data flow is in the opposite direction. Unlike EP0 and EP1, data for both directions can not be simultaneously buffered in the SRAM for EP2. However, the dual buffers and automatic transfer operation (see Section 6.9) allow for sustained 480Mbps transfers across the USB97C201.

6.5 8051 Options

The following 8051 core options are included:

- 256 SRAM in SFR space
- Three timers
- Single serial port
- Extended external inputs (INT2-13)
- External program memory and external data bus (XDATA) are pinned out as a common bus.

6.6 Address Multiplexing

Access to the SRAM for the three access points, ie SIE, ATA DMA, or 8051, is via a time division multiplexing scheme (See Section 6.7). Each of the above blocks have access to read or write the SRAM during one of four sub-periods (the fourth period being reserved for future expansion/idle) of a four phase 15 Mhz clock(ie 60 Mhz slice clock). The values set in the EPx_BUFx , and IN_BUFx, or OUT_BUFx (depending on the direction set for EP2) control the address counter for accesses by the EPs during their time-slice.

The IN_BUFx or OUT_BUFx (again, depending on the direction of EP2) controls the address for ATA access and SRAM_ADDx does so for the 8051 accesses.

Which endpoint has access during the SIE's time-slice is determined by the SIE, ie depending on what endpoint is currently active on the USB bus. Since accesses occur at 15Mhz using DWORDs (32bits), this process is capable of real time concurrency with the USB bus and does not require additional buffering in the SIE. Even if a received packet is ultimately discarded, all that is required to do so is simply not generate the completion interrupt for that endpoint. Similarly for the transmit process, allowing re-transmission.

6.7 SRAM Time Multiplexer Operation

The SRAM access, read or write, occurs in four sequential phases, Ø0-3. These periods are 16.666ns long (60Mhz) and are non-overlapping. Data to/from the SRAM are buffered by local DWORD latches close to the SRAM to minimize high-speed bussing. The rest of the USB97C201 subsystems access these latches during the phases when they are NOT being used to transfer data to/from the SRAM.

6.7.1 PHASE 0 (Ø0)

During this phase, the SIE has access to the SRAM through its associated DWORD latches.

If data from EP0 or EP1 is ready (ie either a full DWORD or the end of a packet has been received), this data will be written into the appropriate buffer address space and the associated EPxRX_BUF register incremented to reflect the amount of buffer used to this point. If data to EP0 or EP1 is required by the SIE, it will load the data from the SRAM into the DWORD latch whose address is determined by an incrementing address counter. This counter will be compared against the EPx_TX register value, to determine if the buffer transfer has been completed.

If the DIR bit in EP2_CTL is "0", and data is requested by the SIE for transmission to the host on EP2, the TOKEN error bit in the USB_ERR register will be set and no other action occurs. If data is received by the SIE on EP2 (IN tokens) and either a full DWORD or EOP has been received, then this data will be written into either the SRAM A or SRAM B buffer space, as appropriate, and the associated RAMWRBC_A/B registers incremented.

If the DIR bit in EP2_CTL is "1", and data is received by the SIE from the host on EP2, the TOKEN error bit in the USB_ERR register will be set and no other action occurs. If data to EP2 is required by the SIE from the SRAM, the data will be loaded in the DWORD latch from the A or B buffer space, as appropriate. The SRAM data address will be determined by an incrementing address counter which will be compared against the RAMRDBC_A/B registers' value to determine if the buffer transfer has been completed.

6.7.2 PHASE 1 (Ø1)

The ATA interface block has access to the SRAM via a DWORD latch during this phase.

If the DIR bit in EP2_CTL is "1", when either a full DWORD or end of DMA has been received by the ATA interface from the ATAPI/ATA device and loaded in to the DWORD latch, it will be written into either the A or B buffer space, as appropriate, and the associated RAMWRBC_A/B registers incremented.

If the DIR bit in EP2_CTL is "0", data will be loaded in the DWORD latch from the A or B buffer space, as appropriate, when the ATA interface requires data to be sent to the ATAPI/ATA device. The SRAM data address will be determined by an incrementing address counter, which will be compared against the RAMRDBC_A/B registers' value to determine if the buffer transfer has been completed.

6.7.3 PHASE 2 (Ø2)

During this phase, the DWORD latch that interfaces to the SRAM_DATA register will be normally repetitively loaded with data READ from the SRAM at the address determined by the higher order bits of the SRAM_ADD1/2 register. The 8051 can read this data with a read to the SRAM_DATA port. Bits 0&1 of the SRAM_ADD1 register will determine the byte read of the DWORD latch.

In order to write data from the 8051 to the SRAM, the 8051 will write the data into the SRAM_DATA register. The sub-byte of the DWORD latch determined by bits 0 & 1 of the SRAM_ADD1 register will be updated, and the entire DWORD will be written to the SRAM at the address determined by the higher order address bits of the SRAM_ADD1/2 registers during the next Ø2 interval. Subsequently, it will return to reading the SRAM data into the DWORD latch on each Ø2 interval. This allows single byte modifications of the the 32 bit wide SRAM to be executed by the 8051.

6.7.4 PHASE 3 (Ø3)

Phase 3 is an idle period during which no accesses occur to the SRAM. This period is reserved for future expansion in derivative products to allow another high speed access path for additional IO.

6.8 EP2 SRAM Buffer Operation

In order to illustrate the operation of the buffering and the interactions between the SIE and ATA control blocks and the firmware, the following scenario will be explained in detail in a timeline format for operation NOT using the Auto Toggle or Auto Transfer features (ie totally firmware controlled):

1. Endpoint 2 is currently receiving data (ie a file segment) from the host for transfer to the ATA interface (DIR bit of EP2_CTL = 0). The SRAM B buffer assigned to EP2 has just been filled with data from the SIE (ie a max packet has been received).
2. Endpoint 2 will be receiving more data (short packet, ie end of file segment) followed by a OUT packet from the host on the control endpoint (EP0) requesting data. Data has already been placed in the SRAM EP0 TX Buffer, its length loaded into the **EP0TX_BC** register, and the TX bit of the EP0TX_CTL register written to a "1".

Phase 0 (Ø0) will refer the 60MHz sub-period that the SIE has access to the SRAM, while Ø1 will be that for the ATA interface and Ø2 will be for the 8051 (Ø3 is idle and reserved).

During one of the Ø0 periods, the SIE finishes loading the last of the packet data into the B buffer. RAMWR_B interrupt bit is set notifying firmware of completion of packet. Assuming that the RAMWR_A=0 (the data in the A SRAM buffer has been previously transferred), the RAMWR_TOGGLE bit is written to a "0" by the firmware, which clears the RAMWRBC_A1/2 registers and directs the next data received from EP2 to the A buffer space in SRAM.

Firmware reads RAMWRBC_B1/2 to determine packet size, loads value into RAMRDBC_B1/2 register. The RAMRD_TOGGLE bit of EP2_CTL is written by the firmware with a "1" which will begin the transfer of the B buffer to ATA interface on the next Ø1 period.

On subsequent slices, the next DWORD of the incoming data packet from the host is loaded into the A buffer space on Ø0 from the SIE, auto-incrementing the RAMWRBC_A1/2 register values. On Ø1 slices, the data from the B buffer space is output to the ATA interface (appropriately flow controlled by that interface), and incrementing a counter which is compared to the RAMRDBC_B1/2 registers to determine if the transfer is completed. During this time, the SIE receives an IN on EP0. During the next Ø0 periods, and until the final transmission of the packet data to the SIE is completed, data is read from the SRAM into the SIE for EP0 in response to INs. The writing of the A buffer by the SIE on Ø0 periods will then resume with the reception of OUTs on EP2.

Assuming the incoming data completes loading into the A buffer space, before the B buffer is transferred to the ATA interface, the RAMWR_A interrupt will be generated before the RAMRD_B interrupt. The firmware will then wait until the RAMRD_B interrupt occurs, loads the RAMRDBC_A1/2 register with the count from the RAMWRBC_A1/2 registers, flips the buffers (ie RAMRD_TOGGLE=0, RAMWR_TOGGLE=1), and clears the RAMWR_B bit (allowing the reuse of the B buffer area).

On subsequent Ø0 slices, the SIE will read (for IN tokens) or write (for OUT tokens) the appropriate SRAM buffer according to which EP is being accessed, if any, while the USB97C201 transfers the A buffer to the ATA interface during Ø1. When an OUT packet on EP0 is received, the data in the SRAM will be transferred to the SIE on subsequent Ø0 slices, DWORD at a time until completed.

6.9 EP2 Automatic Buffer Operations

Automatic operation of the interleaved SRAM buffers exists in two degrees: Automatic toggling of input buffers and automatic transfer of input and output buffer data to/from the SIE and ATA interface. These features may be disabled via bits in the ATA_CTL register.

6.9.1 RECEIVE AUTO-TOGGLE

If the AUTO_TOG bit of the ATA_CTL register is set to a "1", then receive auto-toggling between the A and B buffers for writes to the SRAM is enabled. Figure 3 illustrates the auto-toggle of the receive buffers.

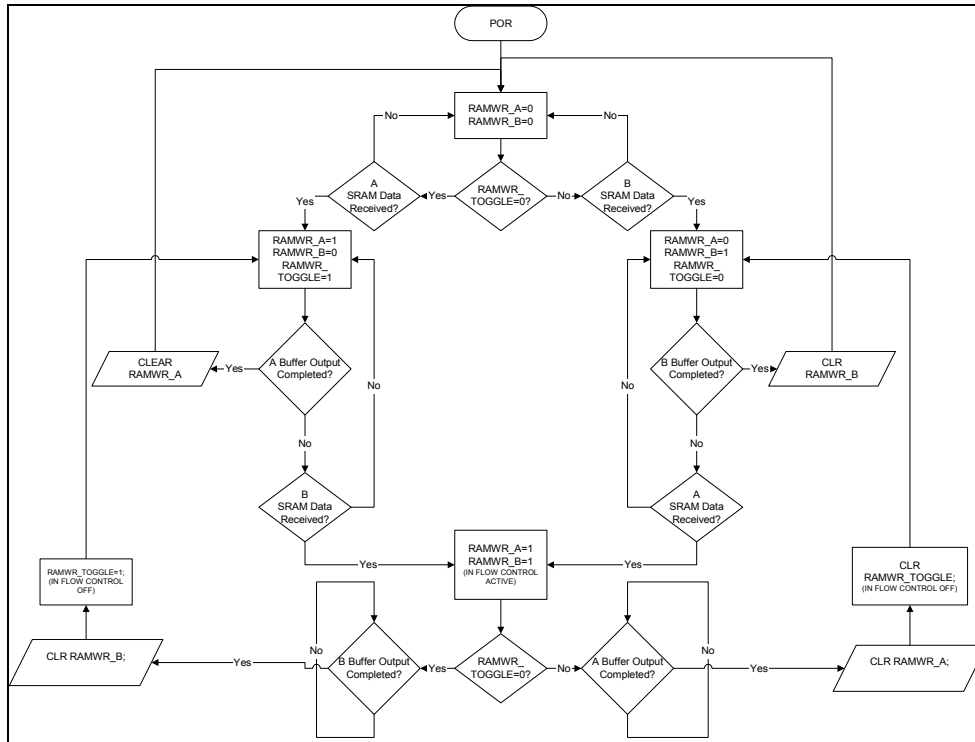

FIGURE 3 - RECEIVE BUFFER OPERATION

Trapezoidal shapes indicate actions performed by the firmware. The hardware state machine is responsible for automatically changing the state of RAMWR_TOGGLE according to the state change of the RAMWR_B and RAMWR_A bits, as shown in **Table 65**. These bits are normally set by the USB97C201 upon completion of loading the A or B SRAM buffer and are normally cleared by the firmware (except when Auto Transfer operation is enabled, see Section 6.9.3).

Note that when both buffers are “full”, ie RAMWR_A and RAMWR_B status bits are BOTH set, that the RAMWR_TOGGLE is not altered and that flow control is initiated on the input source. If this source is the SIE, it will NYET or NAK further OUTs. If it is the ATA interface, nDAK will not be asserted in response to DRQ and data not clocked in to the SRAM.

Table 65 – RAMWR_TOGGLE State Control

RAMWR_B	RAMWR_A	RAMWR_TOGGLE	COMMENT
0	0->1	0->1	A buffer filled; B buffer empty; change to B buffer buffer
0->1	0	1->0	B buffer filled, A buffer empty; change to A buffer buffer
1	0->1	No Change (0)	Both buffers filled; source flow controlled.
0->1	1	No Change (1)	Both buffers filled; source flow controlled
1->0	1	X->1	B buffer emptied; A buffer full; change to A buffer buffer.
1	1->0	X->0	A buffer emptied; B buffer full; change to A buffer buffer.

6.9.2 TRANSMIT BUFFER OPERATION

Figure 4 illustrates the operation of the transmit A and B buffers.

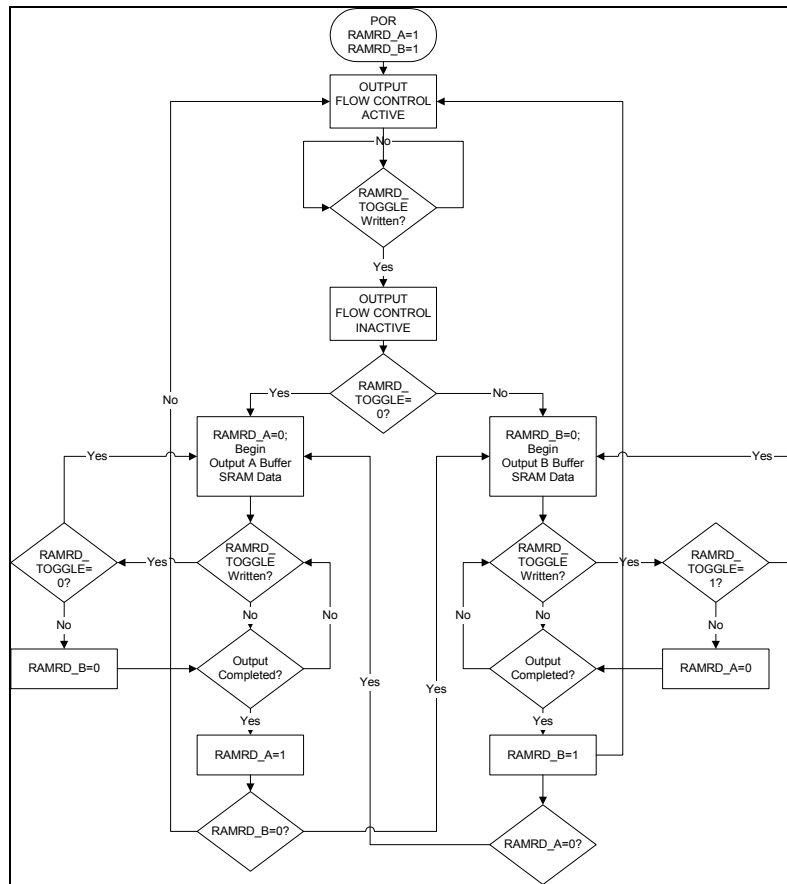

FIGURE 4 - TRANSMIT BUFFER OPERATION

Transmit buffer operations are always initiated by writing the RAMRD_TOGGLE bit in the EP2 Control register. Output flow control to the device receiving data from the SRAM buffer is active once data in both buffers has been transferred. If the destination is the SIE, then it will NYET or NAK further INs. If it is the ATA interface, nDAK will not be asserted in response to DRQ data will not be clocked out.

6.9.3 AUTOMATIC TRANSFER OPERATION

If the AUTO_TRANS bit is set in the ATA_CTL register, then automatic manipulation of the RAMWR_TOGGLE, RAMRD_TOGGLE, RAMWR_B, and RAMWR_A bits is executed by a state machine to allow continuous streaming of the data between EP2 and the ATA DMA interface. Automatic transfer of byte counts between the RAMWRBC_A/B and RAMRDBC_A/B registers is also implemented. This is illustrated in Figure 5.

Note: If the count in RAMWRBC_A/B is zero, no transfer will occur. This is likely to happen on transfers from the SIE to the ATA at the very end of the transfer.

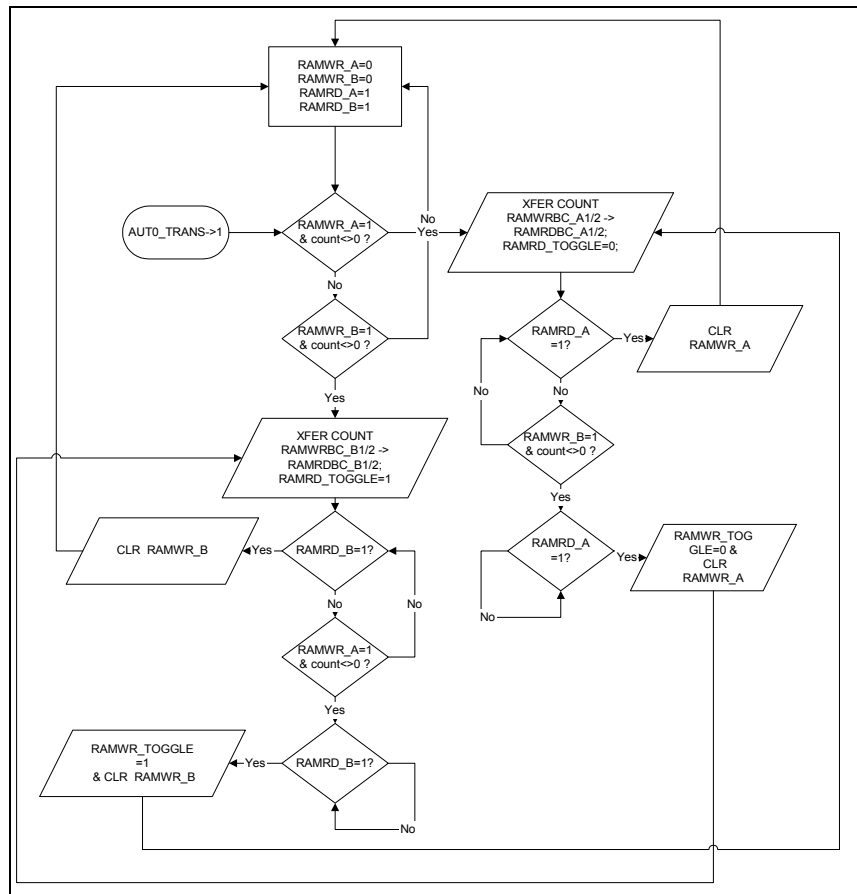

FIGURE 5 - AUTOMATIC DATA TRANSFER OPERATION

The trapezoidal shapes represent actions taken by the state machine.

7.0 DC PARAMETERS

MAXIMUM GUARANTEED RATINGS

Operating Temperature Range	0°C to +70°C
Storage Temperature Range	-55° to +150°C
Lead Temperature Range (soldering, 10 seconds)	+325°C
Positive Voltage on any pin, with respect to Ground	5.5V
Negative Voltage on any pin, with respect to Ground	-0.3V
Maximum V_{DDA} , V_{DDIO}	+3.0V
Maximum V_{DD} , V_{DDP}	+4.0V

*Stresses above the specified parameters could cause permanent damage to the device. This is a stress rating only and functional operation of the device at any other condition above those indicated in the operation sections of this specification is not implied.

Note: When powering this device from laboratory or system power supplies, it is important that the Absolute Maximum Ratings not be exceeded or device failure can result. Some power supplies exhibit voltage spikes on their outputs when the AC power is switched on or off. In addition, voltage transients on the AC power line may appear on the DC output. When this possibility exists, it is suggested that a clamp circuit be used.

DC ELECTRICAL CHARACTERISTICS ($T_A = 0^\circ\text{C} - 70^\circ\text{C}$, V_{DDIO} , $V_{DDA} = +3.3\text{ V} \pm 10\%$, V_{DD} , $V_{DDP} = +2.5\text{ V} \pm 10\%$)

PARAMETER	SYMBOL	MIN	TYP	MAX	UNITS	COMMENTS
I Type Input Buffer						
Low Input Level	V_{ILI}			0.8	V	TTL Levels
High Input Level	V_{IHI}	2.0			V	
ICLK Input Buffer						
Low Input Level	V_{ILCK}			0.4	V	
High Input Level	V_{IHCK}	2.2			V	
Input Leakage (All I and IS buffers)						
Low Input Leakage	I_{IL}	-10		+10	uA	$V_{IN} = 0$
High Input Leakage	I_{IH}	-10		+10	uA	$V_{IN} = V_{DDIO}$
O8 Type Buffer						
Low Output Level	V_{OL}			0.4	V	$I_{OL} = 8\text{ mA} @ V_{DDIO} = 3.3\text{V}$
High Output Level	V_{OH}	2.4			V	$I_{OH} = -4\text{mA} @ V_{DDIO} = 3.3\text{V}$
Output Leakage	I_{OL}	-10		+10	uA	$V_{IN} = 0\text{ to }V_{DDIO}$ (Note 1)

PARAMETER	SYMBOL	MIN	TYP	MAX	UNITS	COMMENTS
I/O8 Type Buffer						
Low Output Level	V_{OL}			0.4	V	$I_{OL} = 8 \text{ mA} @ V_{DDIO} = 3.3\text{V}$
HIGH OUTPUT LEVEL	V_{OH}	2.4			V	$I_{OH} = -4 \text{ mA} @ V_{DDIO} = 3.3\text{V}$
Output Leakage	I_{OL}	-10		+10	μA	$V_{IN} = 0 \text{ to } V_{DDIO}$ (Note 1)
I/O12 Type Buffer						
Low Output Level	V_{OL}			0.4	V	$I_{OL} = 12 \text{ mA} @ V_{DDIO} = 3.3\text{V}$
High Output Level	V_{OH}	2.4			V	$I_{OH} = -6\text{mA} @ V_{DDIO} = 3.3\text{V}$
Output Leakage	I_{OL}	-10		+10	μA	$V_{IN} = 0 \text{ to } V_{DDIO}$ (Note 1)
I/O20 Type Buffer						
Low Output Level	V_{OL}			0.4	V	$I_{OL} = 20 \text{ mA} @ V_{DDIO} = 3.3\text{V}$
High Output Level	V_{OH}	2.4			V	$I_{OH} = -5 \text{ mA} @ V_{DDIO} = 3.3\text{V}$
Output Leakage	I_{OL}	-10		+10	μA	$V_{IN} = 0 \text{ to } V_{DDIO}$ (Note 1)
IO-U						
Note 2						
Supply Current Unconfigured	I_{CCINIT}		85 65		mA	$V_{DD}, V_{DDP} = 2.5\text{V}$ $V_{DDA}, V_{DDIO} = 3.3\text{V}$
Supply Current Active	I_{CC}		90 65	110 75	mA	$V_{DD}, V_{DDP} = 2.5\text{V}$ $V_{DDA}, V_{DDIO} = 3.3\text{V}$

Note 1: Output leakage is measured with the current pins in high impedance.

Note 2: See Appendix A for USB DC electrical characteristics.

Note 3: Supply currents are measured in HS mode.

CAPACITANCE $T_A = 25^\circ\text{C}$; $f_c = 1\text{MHz}$; $V_{DD} = 2.5\text{V}$

PARAMETER	SYMBOL	LIMITS			UNIT	TEST CONDITION
		MIN	TYP	MAX		
Clock Input Capacitance	C_{IN}			20	pF	All pins except USB pins (and pins under test tied to AC ground)
Input Capacitance	C_{IN}			10	pF	
Output Capacitance	C_{OUT}			20	pF	

8.0 AC SPECIFICATIONS

8.1 ATA/ATAPI

The USB97C201 conforms to all timing diagrams and specifications for ATAPI-5 as set forth in the T13/1321D Revision 3 NCITS specification. Please refer to this specification for more information.

8.2 USB2.0 Timing

The USB97C201 conforms to all timing diagrams and specifications for USB peripheral silicon building blocks as set forth in the USB-IF USB 2.0 specification. Please refer to this specification for more information.

9.0 PACKAGING

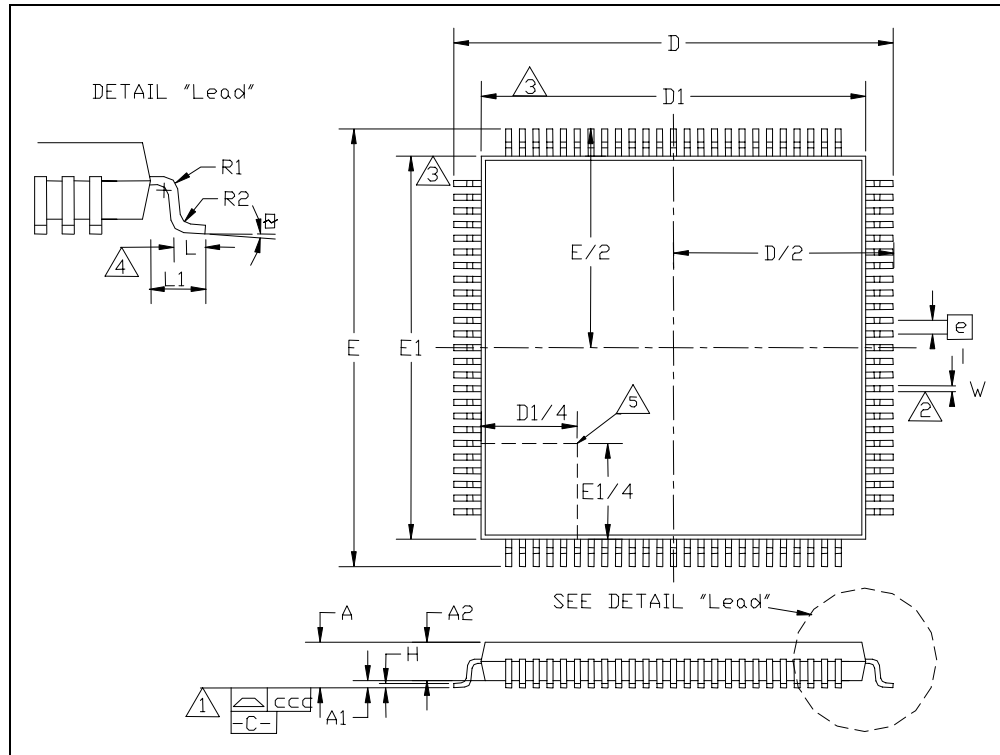

FIGURE 6 - 100 PIN TQFP PACKAGE

	MIN	NOMINAL	MAX	REMARK
A	~	~	1.60	Overall Package Height
A1	0.05	~	0.15	Standoff
A2	1.35	1.40	1.45	Body Thickness
D	13.80	14.00	14.20	X Span
D/2	6.90	7.00	7.10	$\frac{1}{2}$ X Span Measure from Centerline
D1	11.80	12.00	12.20	X body Size
E	13.80	14.00	14.20	Y Span
E/2	6.90	7.00	7.10	$\frac{1}{2}$ Y Span Measure from Centerline
E1	11.80	12.00	12.20	Y body Size
H	0.09	~	0.20	Lead Frame Thickness
L	0.45	0.60	0.75	Lead Foot Length from Centerline
L1	~	1.00	~	Lead Length
e	0.40 Basic			Lead Pitch
θ	0°	3.5°	7°	Lead Foot Angle
W	0.13	0.16	0.23	Lead Width
R1	0.08	~	~	Lead Shoulder Radius
R2	0.08	~	0.20	Lead Foot Radius
ccc	~	~	0.08	Coplanarity

Notes:

Note 1: Controlling Unit: millimeter

Note 2: Minimum space between protrusion and an adjacent lead is .007 mm.

Note 3: Package body dimensions D1 and E1 do not include the mold protrusion. Maximum mold protrusion is 0.25 mm

Note 5: Details of pin 1 identifier are optional but must be located within the zone indicated.

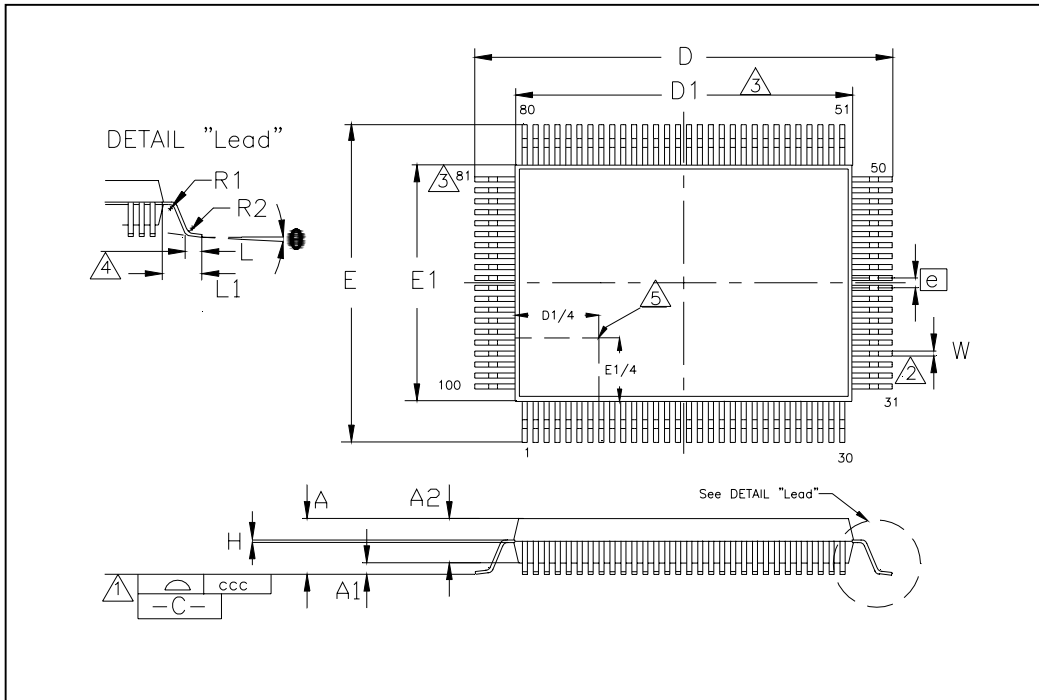

FIGURE 7 – 100 PIN QFP PACKAGE

	MIN	NOMINAL	MAX	REMARKS
A	~	~	3.4	Overall Package Height
A1	0.05	~	0.5	Standoff
A2	2.55	~	3.05	Body Thickness
D	23.65	~	24.15	X Span
D1	19.90	~	20.10	X body Size
E	17.65	~	18.15	Y Span
E1	13.90	~	14.10	Y body Size
H	0.11	~	0.23	Lead Frame Thickness
L	0.73	0.88	1.03	Lead Foot Length
L1	~	1.95	~	Lead Length
e	0.65 Basic			Lead Pitch
θ	0°	~	7°	Lead Foot Angle
W	0.20	~	0.40	Lead Width
R1	0.10	~	0.25	Lead Shoulder Radius
R2	0.15	~	0.40	Lead Foot Radius
ccc	~	~	0.10	Coplanarity

Notes:

- ¹ Controlling Unit: millimeter.
- ² Tolerance on the true position of the leads is ± 0.065 mm maximum
- ³ Package body dimensions D1 and E1 do not include the mold protrusion. Maximum mold protrusion is 0.25 mm.
- ⁴ Dimension for foot length L measured at the gauge plane 0.25 mm above the seating plane.
- ⁵ Details of pin 1 identifier are optional but must be located within the zone indicated.

10.0 USB97C201 REVISIONS

PAGE(S)	SECTION/FIGURE/ENTRY	CORRECTION	DATE REVISED
54	7.0 - DC PARAMETERS	Revised high input leakage on DC Electrical Characteristics table.	11/05/03
26	Table 18 – SRAM Data Port Register	Note about delay required before accessing data.	7/09/02
27	Table 21 - MCU Clock Source Select	CLKVALID settling time described	7/09/02
33	Table 35 – Endpoint 2 Control Register	Note about delay required after setting RAMRD_TOGGLE bits before reading ISR0.	7/09/02
54	DC PARAMETERS	Updated to reflect actual performance.	7/09/02