

ISOLATED DC/DC CONVERTERS

24 Vdc Input 8 Vdc / 5 A Output 1/16 Brick

bel
POWER PRODUCTS

xRSB-50R08x

RoHS Compliant

Rev.A

- Isolated
- Fixed Frequency (600 kHz)
- High Efficiency
- High Power Density
- Low Cost
- Output Voltage Trim
- Basic Insulation
- Input Under Voltage Lockout
- Output Over Voltage Shutdown
- OCP/SCP
- Over Temperature Protection
- Remote On/Off (option)
- Positive/Negative Remote Sense
- Through Hole and SMT (option)

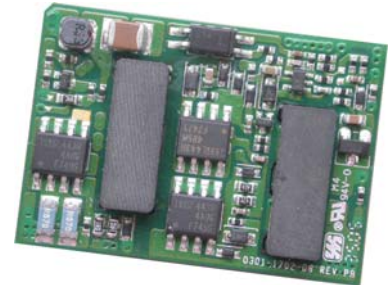

Description

The xRSB-50R08x series are isolated dc/dc converters that operate from a nominal 24 Vdc source. These units will provide up to 40 W of output power from a nominal 24 Vdc input. These units are designed to be highly efficient and low cost. Features include remote on/off, over current protection and under voltage lockout. These converters are provided in an industry standard sixteenth brick package.

Part Selection

Output Voltage	Input Voltage	Max. Output Current	Max. Output Power	Typical Efficiency	Model Number Active Low	Model Number Active High
8 V	18 V - 36 V	5 A	40 W	90%	xRSB-50R08L	xRSB-50R080

- Notes:** 1. Add "G" suffix at the end of the model number to indicate Tray Packaging. Replace "x" with "S" to indicate SMT package, or "0" to indicate through hole package.
2. All part numbers above indicate RoHS 6. Change the second letter "R" to "7" for RoHS 5 part numbers.

Absolute Maximum Ratings

Parameter	Min	Typ	Max	Notes
Input Voltage (continuous)	-0.3 V	-	40 V	
Remote On/Off	-0.3 V	-	18 V	
I/O Isolation Voltage	-	-	1500 V	
Ambient Temperature	-40 °C	-	85 °C	
Storage Temperature	-55 °C	-	125 °C	

Input Specifications

Parameter	Min	Typ	Max	Notes
Input Voltage	18 V	24 V	36 V	
Input Current (full load)	-	-	3.5 A	
Input Current (no load)	-	80 mA	160 mA	
Remote Off Input Current	-	1 mA	3 mA	
Input Reflected Ripple Current (pk-pk)	-	20 mA	50 mA	Tested with simulated source impedance of 15 uH, 5 Hz to 20 MHz; use a 100 uF/100 V electrolytic capacitor with ESR=1 ohm max at 200 kHz at the input.
Input Reflected Ripple Current (rms)	-	3 mA	7 mA	
I ² t Inrush Current Transient	-	0.01 A ² s	0.02 A ² s	
Turn On Voltage Threshold	-	17 V	-	
Turn Off Voltage Threshold	-	16 V	-	

Note: All specifications are typical at nominal input, full load at 25 °C unless otherwise stated.

ISOLATED DC/DC CONVERTERS

24 Vdc Input 8 Vdc / 5 A Output 1/16 Brick



Output Specifications

Parameter	Min	Typ	Max	Notes	
Output Voltage Set Point	7.88 V	8 V	8.12 V	Vin=24 V; Io=50% load	
Line Regulation	-	±5 mV	±10 mV		
Load Regulation	-	±5 mV	±10 mV		
Regulation Over Temperature(-40 °C to +85 °C)	-	±20 mV	±35 mV		
Output Current	0 A	-	5 A		
Current Limit Threshold	6 A	7.5 A	9 A		
Short Circuit Surge Transient	-	0.5 A ² s	1 A ² s		
Ripple and Noise (rms)	-	10 mV	20 mV	Tested at 0-20 MHz BW, with a 1 uF ceramic capacitor and a 10 uF Tantalum capacitor at the output.	
Ripple and Noise (pk-pk)	-	40 mV	75 mV		
Turn on Time	-	24 mS	50 mS		
Overshoot at Turn on	-	0%	5%		
Output Capacitance	100 uF	-	680 uF		
Transient Response					
25% ~ 50% Max Load	Overshoot	Vo=8 V	-	150 mV	Test conditions: di/dt = 0.1 A/uS, Vin=24 V, with a 1 uF ceramic capacitor and a 10 uF Tantalum capacitor at the output.
	Settling Time		-	120 uS	
50% ~ 25% Max Load	Overshoot		-	150 mV	
	Settling Time		-	120 uS	

Note: All specifications are typical at nominal input, full load at 25 °C unless otherwise stated.

General Specifications

Parameter	Min	Typ	Max	Notes
Efficiency	87%	90%	-	Vin=24 V; Io=Io, max; full load
Switching Frequency	540 kHz	600 kHz	660 kHz	
Isolation Capacitance	-	3900 pF	-	
Output Voltage Trim Range	90% Vo	-	110% Vo	
Over Temperature Protection	120 °C	-	140 °C	
Over Voltage Protection	-	130% Vo	140% Vo	Test conditions: Vin=24 V, full load and short the feedback optocoupler.
MTBF	TBD			Calculated Per Bell Core SR-332 (Io = Nominal; Ta = 25 °C)
Dimensions	Inches (L x W x H)	1.3 x 0.9 x 0.334		SMT Package
	Millimeters (L x W x H)	33.0 x 22.9 x 8.49		
Dimensions	Inches (L x W x H)	1.3 x 0.9 x 0.378		Through Hole Package
	Millimeters (L x W x H)	33.0 x 22.9 x 9.60		
Weight	-	13 g	-	

Note: All specifications are typical at 25 °C unless otherwise stated.

ISOLATED DC/DC CONVERTERS

24 Vdc Input 8 Vdc / 5 A Output 1/16 Brick



Control Specifications

Parameter		Min	Typ	Max	Notes
Remote On/Off					
Signal Low (Unit On)	Active Low	-0.3 V	-	0.8 V	When Remote On/Off pin is open, for active low option, unit is off; for active high option, unit is on
Signal High (Unit Off)		2.95 V	-	18 V	
Signal Low (Unit Off)	Active High	-0.3 V	-	0.8 V	
Signal High (Unit On)		2.95 V	-	18 V	
Current Sink	-	0 mA	-	1 mA	

Output Trim Equations

Equations for calculating the trim resistor are shown below. The Trim Down resistor should be connected between the Trim pin and Ground pin. The Trim Up resistor should be connected between the Trim pin and the Vout. Only one of the resistors should be used for any given application.

$$R_{trimdown} = \frac{511}{|\delta|} - 10.22 [k\Omega]$$

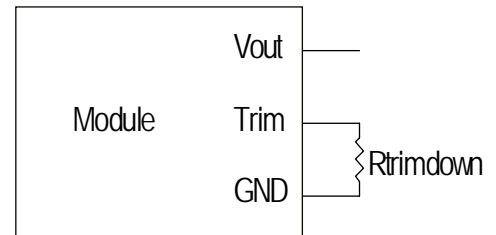

$$R_{trimup} = \frac{(100 + \delta) \cdot V_o \cdot 5.11 - 626}{1.225 \cdot \delta} - 10.22 [k\Omega]$$

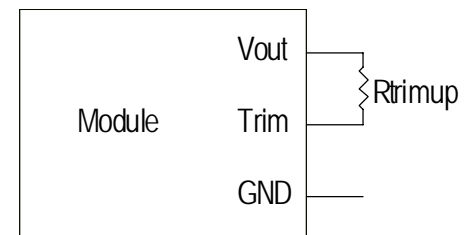

Note:

$$\delta = \frac{(V_o_{req} - V_o)}{V_o} \times 100 [\%]$$

V_o_{req} =Desired (trimmed) output voltage[V]
Output voltage V_o =8.003 V

ISOLATED DC/DC CONVERTERS

24 Vdc Input 8 Vdc / 5 A Output 1/16 Brick



Efficiency Data

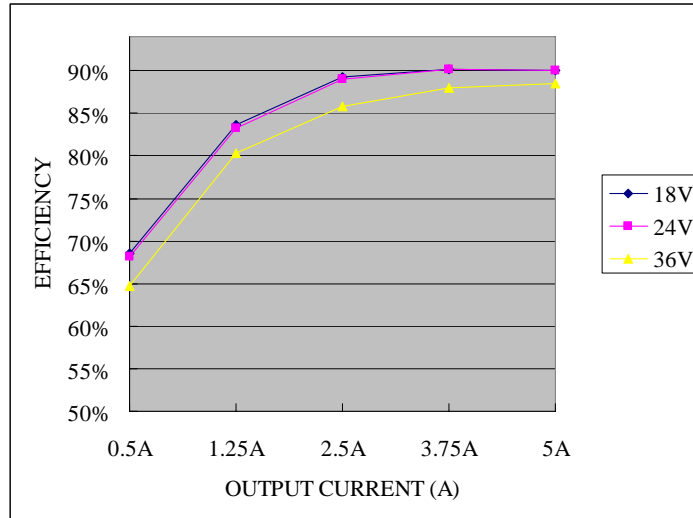

Thermal Derating Curve

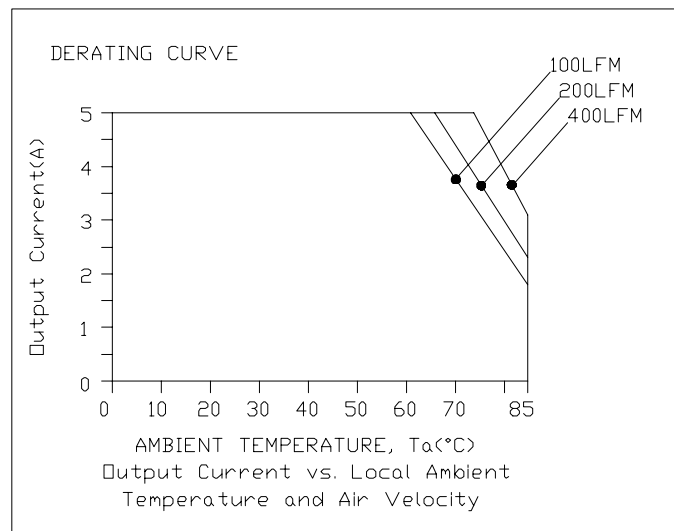

ISOLATED DC/DC CONVERTERS

24 Vdc Input 8 Vdc / 5 A Output 1/16 Brick



Ripple and Noise Waveform

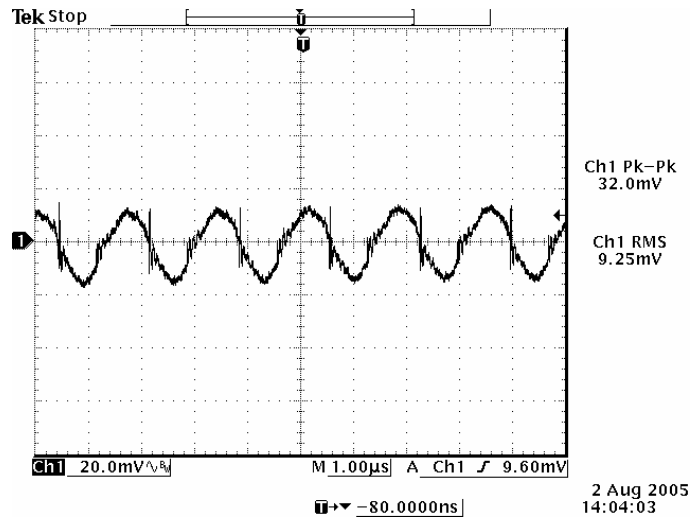

24 Vdc input, 1.2 V output

Note: Ripple and noise at full load, with a 1µF ceramic cap and a 100 µF Tantalum cap at output, Ta=25 deg C.

Transient Response Waveforms

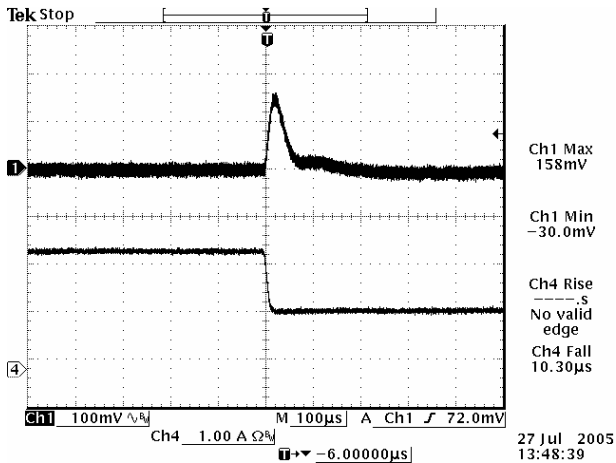

Vout=8.0 V 50% to 25% Load Transients

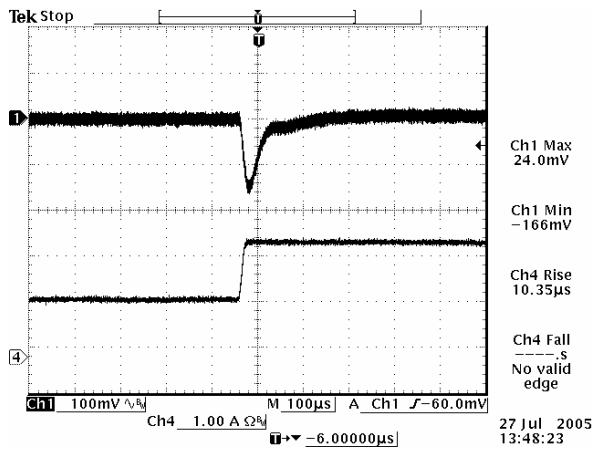

Vout=8.0 V 25% to 50% Load Transients

Note: Transient Response at Vin=48 V, di/dt=0.1A/µS, external 100 µF Tantalum cap and 1µF Ceramic cap, Ta=25 deg C.

ISOLATED DC/DC CONVERTERS

24 Vdc Input 8 Vdc / 5 A Output 1/16 Brick



Mechanical Outline

SMT Package

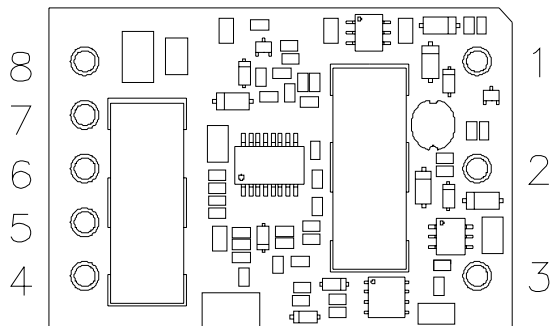
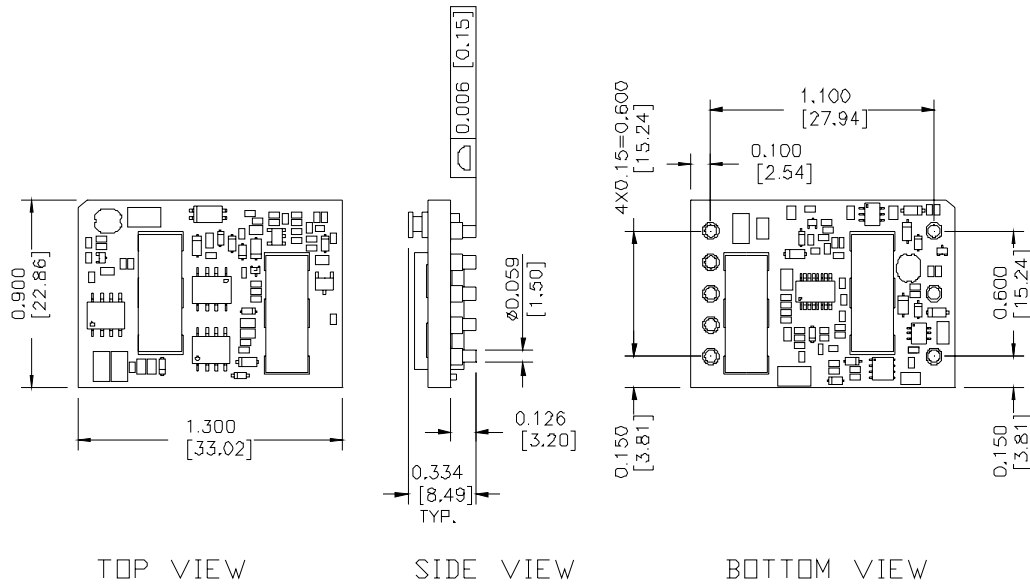

RECOMMENDED PCB PAD LAYOUT

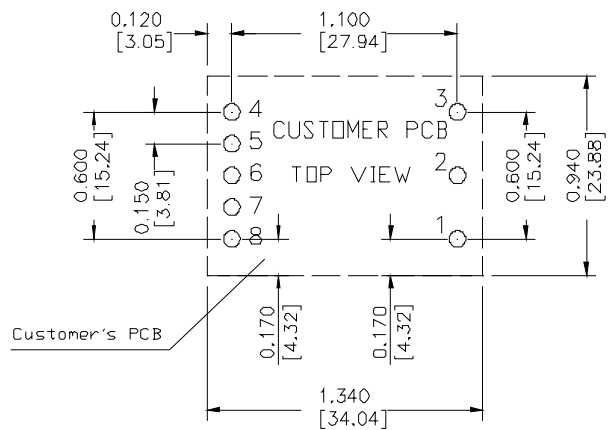

Pin Connections

Pin	Function
1	Vin (+)
2	Remote On/Off
3	Vin (-)
4	Vout-
5	Remote Sense (-)
6	Trim
7	Remote Sense (+)
8	Vout (+)

Recommended Surface Mount Pads
 Min. ϕ 0.080" [2.03]
 Max. ϕ 0.092" [2.34]

ISOLATED DC/DC CONVERTERS

24 Vdc Input 8 Vdc / 5 A Output 1/16 Brick



Through Hole Package

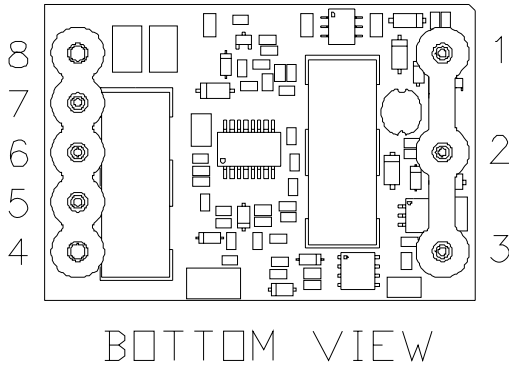
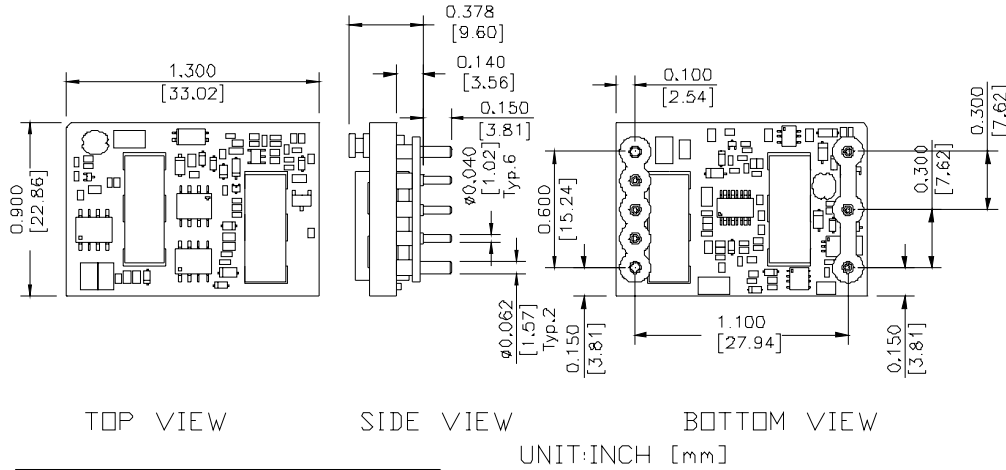

RECOMMENDED PCB PAD LAYOUT

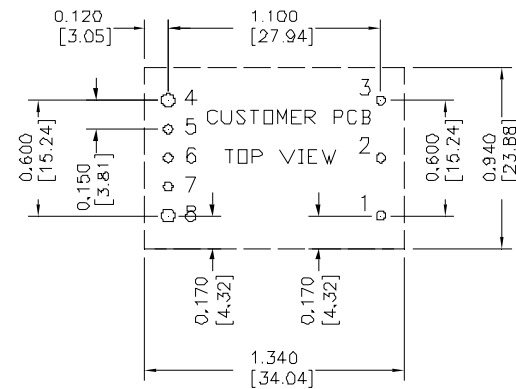

HOLE SIZE: 1-3, 5-7 ϕ 0.047 [1.19],
 4,8 ϕ 0.07 [1.78]
 PAD SIZE: 1-3, 5-7 ϕ 0.08 [2.03]
 4,8 ϕ 0.10 [2.54]

Pin Connections

Pin	Function
1	Vin (+)
2	Remote On/Off
3	Vin (-)
4	Vout-
5	Remote Sense (-)
6	Trim
7	Remote Sense (+)
8	Vout (+)

RoHS Compliance

Complies with the European Directive 2002/95/EC, calling for the elimination of lead and other hazardous substances from electronic products.



©2007 Bel Fuse Inc. Specifications subject to change without notice. 012907

CORPORATE

Bel Fuse Inc.
 206 Van Vorst Street
 Jersey City, NJ 07302
 Tel 201-432-0463
 Fax 201-432-9542
www.belfuse.com

FAR EAST

Bel Fuse Ltd.
 8F/ 8 Luk Hop Street
 San Po Kong
 Kowloon, Hong Kong
 Tel 852-2328-5515
 Fax 852-2352-3706
www.belfuse.com

EUROPE

Bel Fuse Europe Ltd.
 Preston Technology Management Centre
 Marsh Lane, Suite G7, Preston
 Lancashire, PR1 8UD, U.K.
 Tel 44-1772-556601
 Fax 44-1772-888366
www.belfuse.com