

SKN 400



Stud Diode

Rectifier Diode

SKN 400

Features

- Reverse voltages up to 3000 V
- Hermetic metal case with ceramic insulator with extra long creepage distances
- Threaded stud ISO M24 x 1,5
- SKN: anode to stud

Typical Applications

- High voltage rectifier diode, especially for traction applications
- Cooling via heatsinks
- Non-controllable and half-controllable rectifiers
- Free-wheeling diodes
- Recommended snubber network:
RC: 1 μ F, 20 Ω ($P_R = 2$ W),
 $R_p = 25$ k Ω ($P_R = 20$ W)

V_{RSM} V	V_{RRM} V	$I_{FRMS} = 700$ A (maximum value for continuous operation) $I_{FAV} = 400$ A (sin. 180; $T_c = 100$ °C)	
1800	1800	SKN 400/18	
2400	2400	SKN 400/24	
2700	2700	SKN 400/27	
3000	3000	SKN 400/30	

Symbol	Conditions	Values	Units
I_{FAV}	sin. 180; $T_c = 85$ (100) °C	445 (400)	A
I_D	K 0,55; $T_a = 45$ °C; B2 / B6	310 / 450	A
	K 0,55F; $T_a = 35$ °C; B2 / B6	700 / 1000	A
I_{FSM}	$T_{vj} = 25$ °C; 10 ms	9000	A
	$T_{vj} = 160$ °C; 10 ms	7500	A
i^2t	$T_{vj} = 25$ °C; 8,3 ... 10 ms	400000	A ² s
	$T_{vj} = 160$ °C; 8,3 ... 10 ms	280000	A ² s
V_F	$T_{vj} = 25$ °C; $I_F = 1200$ A	max. 1,45	V
$V_{(TO)}$	$T_{vj} = 160$ °C	max. 0,9	V
r_T	$T_{vj} = 160$ °C	max. 0,5	m Ω
I_{RD}	$T_{vj} = 160$ °C; $V_{RD} = V_{RRM}$	max. 60	mA
Q_{rr}	$T_{vj} = 160$ °C; $-di_F/dt = 10$ A/ μ s	400	μ C
$R_{th(j-c)}$		0,11	K/W
$R_{th(c-s)}$		0,01	K/W
T_{vj}		- 40 ... + 160	°C
T_{stg}		- 55 ... + 160	°C
V_{isol}		-	V~
M_s	to heatsink	60	Nm
a		5 * 9,81	m/s ²
m	approx.	500	g
Case		E 17	



SKN

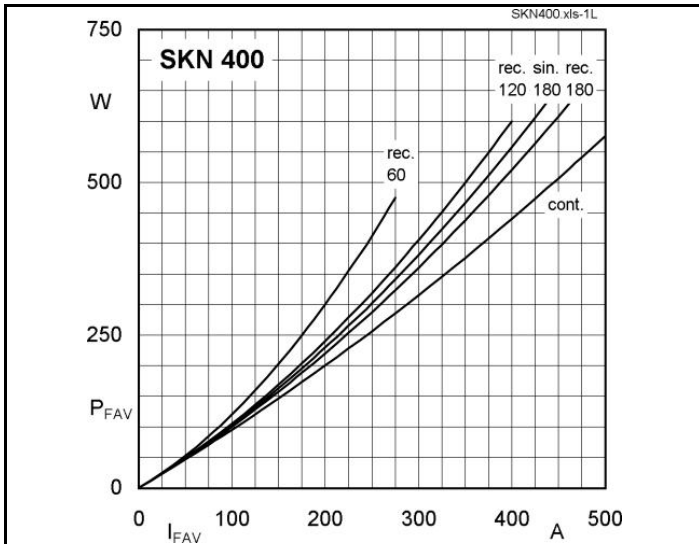

Fig. 1L Power dissipation vs. forward current

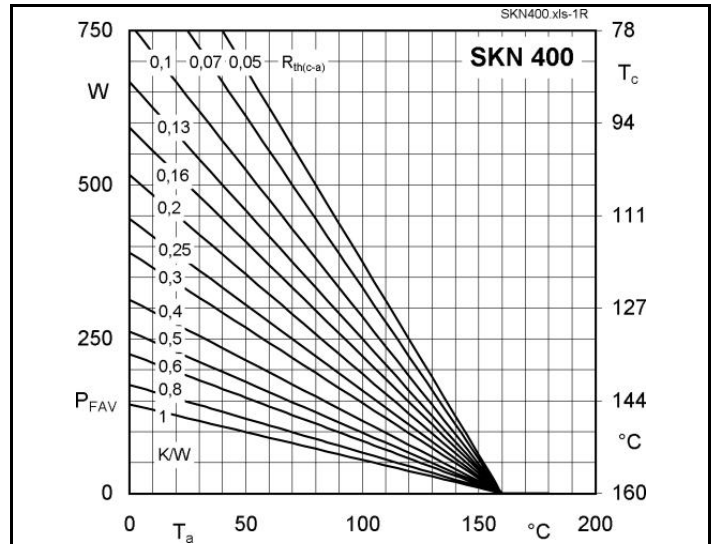

Fig. 1R Power dissipation vs. ambient temperature

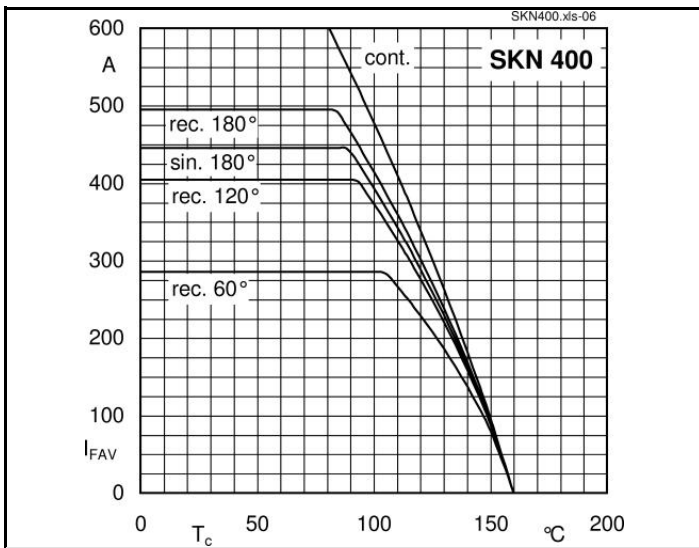

Fig. 2 Forward current vs. case temperature

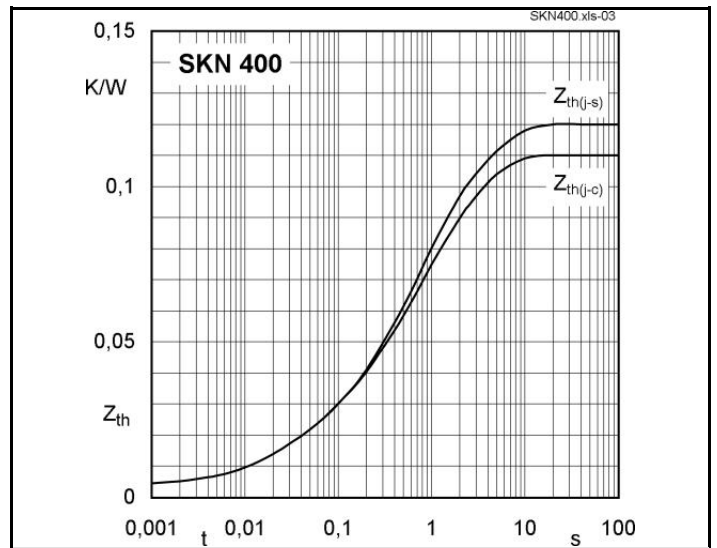

Fig. 4 Transient thermal impedance vs. time

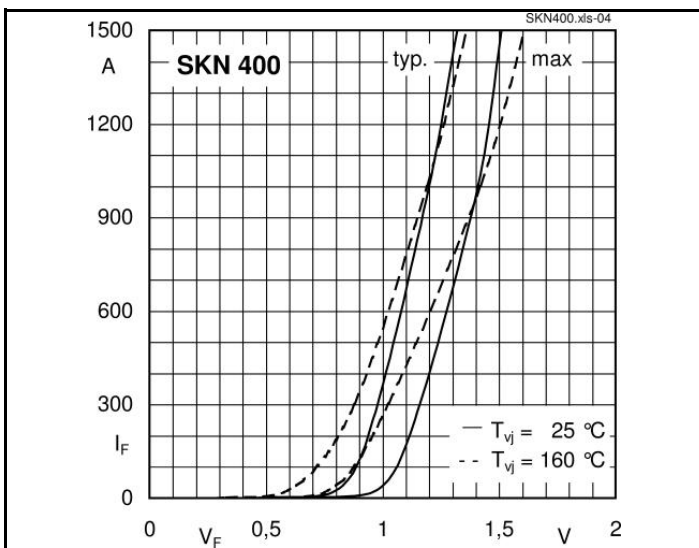

Fig. 5 Forward characteristics

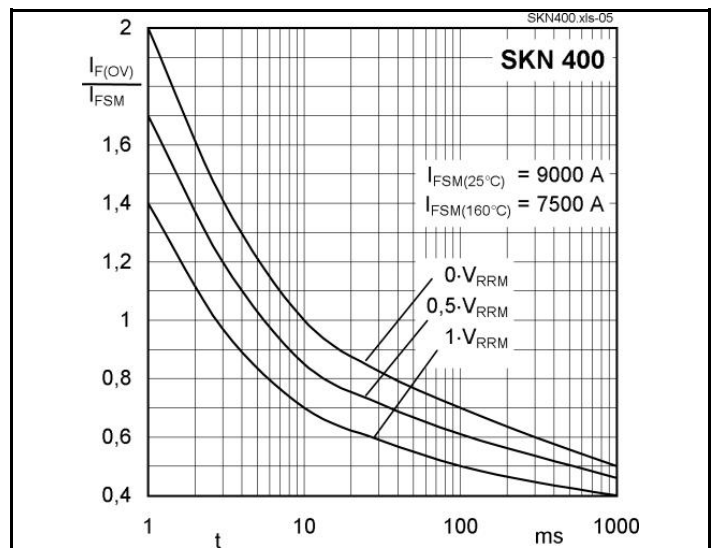
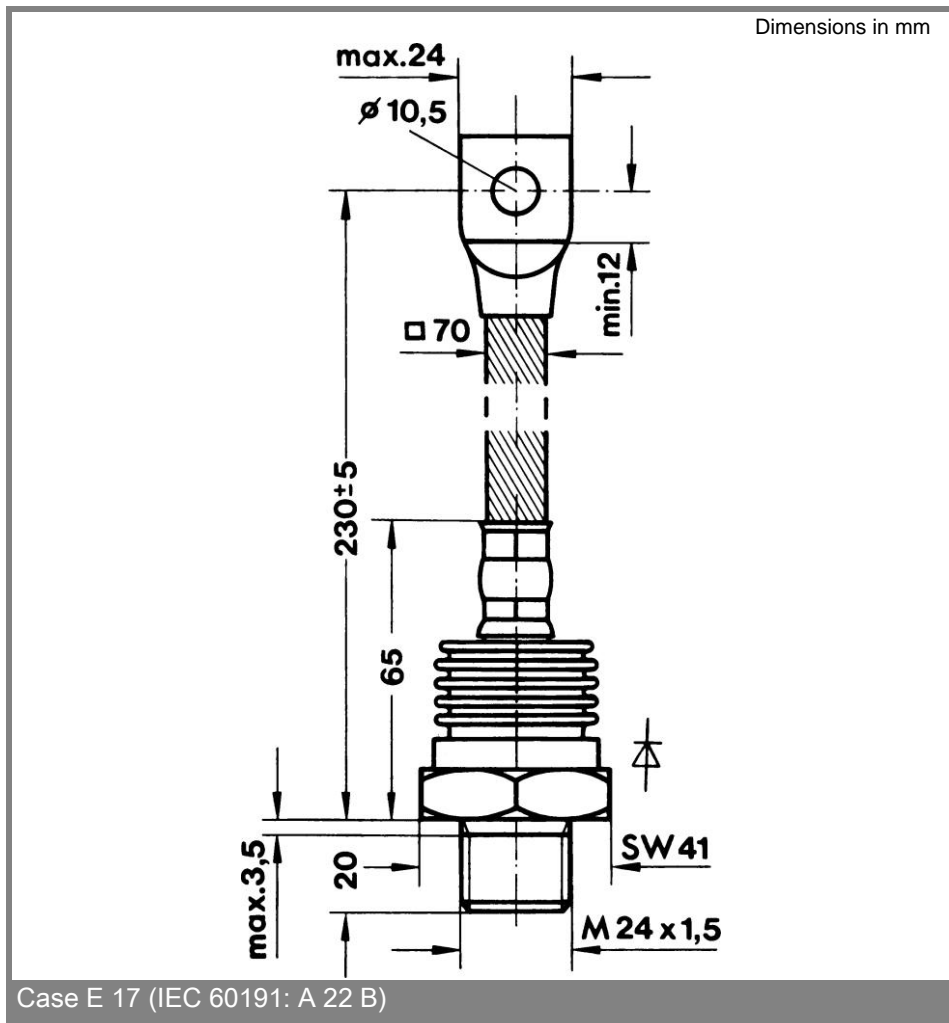

Fig. 6 Surge overload current vs. time



This technical information specifies semiconductor devices but promises no characteristics. No warranty or guarantee expressed or implied is made regarding delivery, performance or suitability.